

# Yamato

## Programmable Low Temperature Incubator

Model

# IN604/804

### Instruction Manual

- First Edition -

- Thank you for purchasing " Programmable Low Temperature Incubator, IN Series" of Yamato Scientific Co., Ltd.
- To use this unit properly, read this "Instruction Manual" thoroughly before using this unit. Keep this instruction manual around this unit for referring at anytime.



**WARNING!**

Carefully read and thoroughly understand the important warning items described in this manual before using this unit.

**Yamato Scientific Co., LTD.**



◆ <b>Cautions in Using with Safety</b> .....	<b>1</b>
• Explanation.....	1
• Table of Illustrated Symbols .....	2
• Fundamental Matters of "WARNING!" and "CAUTION!" .....	3
◆ <b>Before Using this unit</b> .....	<b>4</b>
• Requirements for Installation.....	4
• When Using the Unit .....	7
• Defrost in Refrigerator .....	8
◆ <b>Description and Function of Each Part</b> .....	<b>9</b>
• Main Unit .....	9
• Structure Chart .....	11
• Control Panel.....	13
◆ <b>Operation Method</b> .....	<b>14</b>
• Key Operation Chart of Mode Setting and Program Registering .....	14
• Operation Mode and Function List .....	15
• Fixed Temperature Operation.....	17
• Auto Stop Operation .....	20
• Auto Start Operation.....	23
• Program Operation.....	25
• Input Program.....	28
• Program Creation Example .....	34
• Set Clock.....	38
• Set the Timer Mode .....	40
• Set the Key Lock Mode .....	41
• Set the Buzzer Mode.....	42
• Calibration Offset Function.....	43
• Integrating Operation Time.....	45
• Manual Defrost Operation .....	45
• Set the Defrost Operation Mode.....	46
• Set the Cycle Defrost Operation Time.....	47
• Set the Refrigerator Operation Mode .....	48
• Set the Communication Lockout Mode (Optional accessory) .....	49
• The Independent Overheating Prevention Device .....	50

◆ <b>Handling Precautions</b> .....	<b>51</b>
◆ <b>Maintenance Method</b> .....	<b>52</b>
• Daily Inspection and Maintenance .....	52
◆ <b>Long storage and disposal</b> .....	<b>53</b>
• When not using this unit for long term / When disposing .....	53
◆ <b>In the Event of Failure</b> ... ..	<b>54</b>
• Error Indication .....	54
• Trouble Shooting .....	55
◆ <b>After Service and Warranty</b> .....	<b>56</b>
◆ <b>Specification</b> .....	<b>57</b>
◆ <b>Wiring Diagram</b> .....	<b>59</b>
◆ <b>Replacement Parts Table</b> .....	<b>61</b>
◆ <b>Reference</b> .....	<b>62</b>
• List of Dangerous Substances .....	62

## Explanation

### MEANING OF ILLUSTRATED SYMBOLS

#### Illustrated Symbols

Various symbols are used in this safety manual in order to use the unit without danger of injury and damage of the unit. A list of problems caused by ignoring the warnings and improper handling is divided as shown below. Be sure that you understand the warnings and cautions in this manual before operating the unit.

---

---

 **WARNING!** If the warning is ignored, there is the danger of a problem that may cause a serious accident or even fatality.

 **CAUTION!** If the caution is ignored, there is the danger of a problem that may cause injury/damage to property or the unit itself.

---

---

#### Meaning of Symbols



This symbol indicates items that urge the warning (including the caution). A detailed warning message is shown adjacent to the symbol.



This symbol indicates items that are strictly prohibited. A detailed message is shown adjacent to the symbol with specific actions not to perform.



This symbol indicates items that should be always performed. A detailed message with instructions is shown adjacent to the symbol.

# Cautions in Using with Safety

## Table of Illustrated Symbols

### Warning



Warning,  
generally



Warning,  
high voltage



Warning,  
high temperature



Warning,  
drive train



Warning,  
explosive

### Caution



Caution,  
generally



Caution,  
electrical shock



Caution,  
scald



Caution,  
no road heating



Caution,  
not to drench



Caution,  
water only



Caution,  
deadly poison

### Prohibit



Prohibit,  
generally



Prohibit,  
inflammable



Prohibit,  
to disassemble



Prohibit,  
to touch

### Compulsion



Compulsion,  
generally



Compulsion,  
connect to the  
grounding  
terminal



Compulsion,  
install on a flat  
surface



Compulsion,  
disconnect the  
power plug



Compulsion,  
periodical  
inspection

## Cautions in Using with Safety

### Fundamental Matters of "WARNING!" and "CAUTION!"

#### **WARNING!**

##### **Do not use this unit in an area where there is flammable or explosive gas**

Never use this unit in an area where there is flammable or explosive gas. This unit is not explosion-proof. An arc may be generated when the power switch is turned on or off, and fire/explosion may result. (Refer to page 62 "List of Dangerous Substances".)

##### **Always ground this unit**

Always ground this unit on the power equipment side in order to avoid electrical shock due to a power surge.

##### **If a problem occurs**

If smoke or strange odor should come out of this unit for some reason, turn off the power key right away, and then turn off the circuit breaker and the main power. Immediately contact a service technician for inspection. If this procedure is not followed, fire or electrical shock may result. Never perform repair work yourself, since it is dangerous and not recommended.

##### **Do not use the power cord if it is bundled or tangled**

Do not use the power cord if it is bundled or tangled. If it is used in this manner, it can overheat and fire may be caused.

##### **Do not process, bend, wring, or stretch the power cord forcibly**

Do not process, bend, wring, or stretch the power cord forcibly. Fire or electrical shock may result.

##### **Substances that can not be used**

Never use explosive substances, flammable substances and substances that include explosive or flammable ingredients in this unit. Explosion or fire may occur. (Refer to page 62 "List of Dangerous Substances".)

##### **Do not touch high-temperature parts**

The inside of the body or the door may become hot during and just after operation. It may cause burns.

#### **CAUTION!**

##### **During a thunder storm**

During a thunderstorm, turn off the power key immediately, then turn off the circuit breaker and the main power. If this procedure is not followed, fire or electrical shock may be caused.

## Requirements for Installation

### **WARNING!**

#### 1. Always ground this unit



- Be sure to connect the earth wire (the green cable of power cord) to the grounding conductor or ground terminal to prevent accidents caused by electric leakage.



- Do not connect the earth wire to gas or water pipes. If not, fire disaster may be caused.
- Do not connect the earth wire to the ground for telephone wire or lightning conductor. If not, fire disaster or electric shock may be caused.
- Do not use a branching receptacle, which may cause the heat generation.

#### 2. Choose a proper place for installation



- Do not install this unit in a place where:
  - ◆ Rough or dirty surface.
  - ◆ Flammable gas or corrosive gas is generated.
  - ◆ Ambient temperature exceeds 35°C.
  - ◆ Ambient temperature fluctuates violently.
  - ◆ There is direct sunlight.
  - ◆ There is excessive humidity and dust.
  - ◆ There is a constant vibration.



- Install this unit on a stable place with the space as shown below.

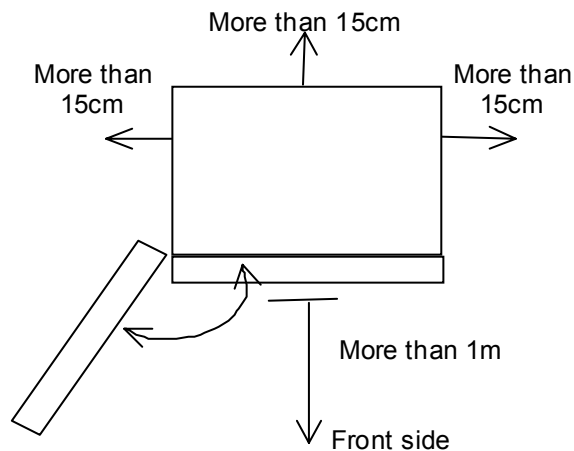

#### 3. Caution at defrost



- Catch drain from drain hose with a tray at defrost.

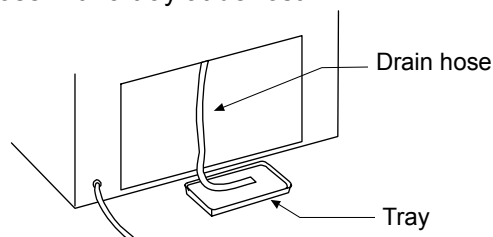

Note: The tray is not included in the attachments of unit.



## Requirements for Installation

### 4. Do not use this unit in an area where there is flammable or explosive gas



- Never use this unit in an area where there is flammable or explosive gas. This unit is not explosion-proof. An arc may be generated when the power switch is turned ON or OFF, and fire/explosion may result. (Refer to page 62 "List of Dangerous Substances".)

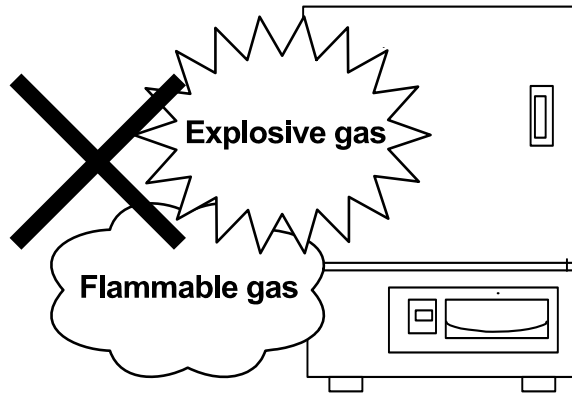

### 5. Do not modify



- Modification of this unit is strictly prohibited. This could cause a failure.

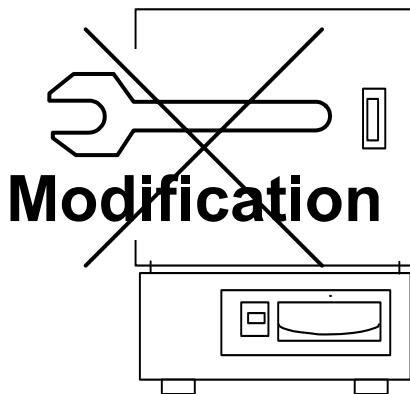

### 6. Installation on horizontal surface



- Set this unit to the flattest place. Setting this unit on rough or slope place could cause the vibration or noise, or cause the unexpected trouble or malfunction.

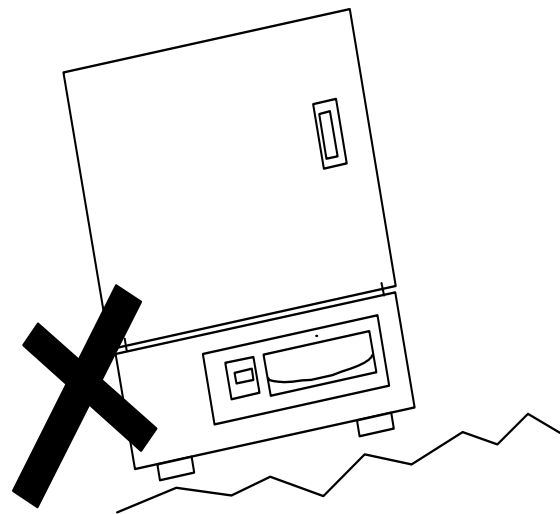

## Requirements for Installation

### 7. Choose a correct power distribution board or receptacle



- Choose a correct power distribution board or receptacle that meets the unit's rated electric capacity.

**Electric capacity:** IN604: 100V AC 10A, IN804: 100V AC 12A

NOTE)

Starburst connection with a branching receptacle or extended wiring with a cord reel lowers electrical power voltage, which may cause the degradation of the refrigeration capability or temperature control performance.

### 8. Handling of power code



- Do not entangle the power cord. This will cause overheating and possibly a fire.
- Do not bend or twist the power cord, or apply excessive tension to it. This may cause a fire and electrical shock.
- Do not lay the power cord under a desk or chair, and do not allow it to be pinched in order to prevent it from being damaged and to avoid a fire or electrical shock.
- Keep the power cord away from any heating equipment such as a room heater. The cord's insulation may melt and cause a fire or electrical shock.



- If the power cord becomes damaged (wiring exposed, breakage, etc.), immediately turn off the power at the rear of this unit and shut off the main supply power. Then contact your nearest dealer for replacement of the power cord. Leaving it may cause a fire or electrical shock.
- Connect the power plug to the receptacle which is supplied appropriate power and voltage.

### 9. Before/after installing



- It may cause injure to a person if this unit falls down or moves by the earthquake and the impact. etc..To prevent, take measures that the unit cannot fall down, and not install to busy place.

## When Using the Unit

### **CAUTION!**

#### 1. Do not use explosive or flammable substance



- Never use explosive substances, flammable substances and substances that include explosive or flammable ingredients in this unit. Explosion or fire may occur.

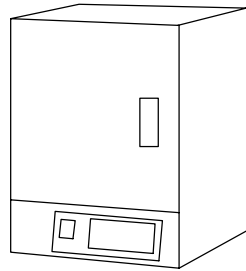

Flammable  
or explosive  
substance

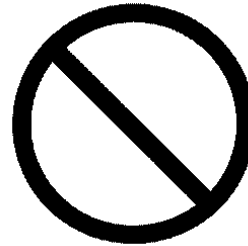

#### 2. Do not make an overload



- The withstand load of shelf is 15kg (uniform load) Set the samples apart each other.

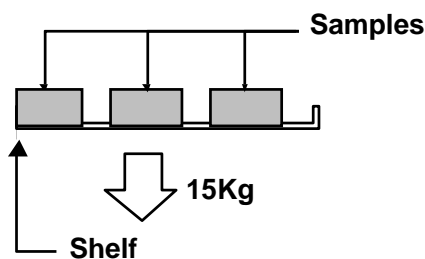

#### 3. Do not set samples in close formation



- The temperature in furnace cannot be controlled if too much samples are set there. Make sure to use the shelf and set samples apart each other so as to make the free space of 30% or more to the furnace to acquire accuracy of temperature.

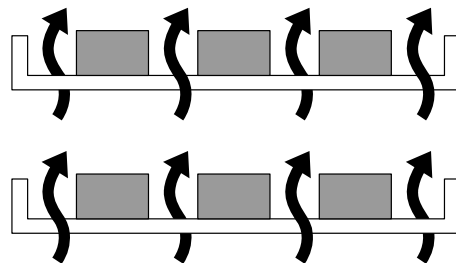

Make the free space of 30% or more

#### 4. Notes for some kind of sample



- Stainless steel SUS304 is used for interior; however, it may be corroded by strong acid etc. And the door packing made of rubber may be corroded by some kind of solvent, e.g. alkaline, oil, halogen etc.
- Much frost on the evaporator degrades the refrigeration capability, which may cause uncontrollability of setting temperature. Be careful, especially, to treat samples with large water content that generate much frost. Perform the defrost operation if frost is observed through the frost inspection window.
- The equipment with large heat load cannot be used because the temperature in furnace increases.

## Defrost in Refrigerator

Much frost on the evaporator degrades the refrigeration capability, which may cause uncontrollability of setting temperature. In the **IN604 or IN804**, the condition of frost on the evaporator can be checked through the frost inspection window inside furnace. The frosting speed varies depending on the following conditions.

- 1) Temperature used ······ Easily frosted when using the unit in low temperature
- 2) External temperature/humidity ··· Easily frosted when external temperature/humidity is higher
- 3) Sample in furnace ······ Easily frosted when sample contains much water

The following operations can be set to take measure against frosting in the **IN604 or IN804**. Set either of them depending on the situation. The fixed temperature and program operation are available there by pressing the DEFROST key on the operation panel, in addition to the program operation.

① Manual defrost operation (manual start/automatic stop):

Perform the defrost operation if much frost is in the evaporator. Temperature control is suspended in addition to stop of heater and blast fan during operation. The operation is started manually and stopped automatically with the built-in timer after 5-minute operation.

→Refer to the page 45 for the operating instructions.

② Cycle defrost operation (Automatic start/stop):

Set the cycle defrost operation to operate the unit effectively for long term. The unit can repeat the defrost operation and operation stop automatically at specified interval specified previously. Frost can be usually removed to perform the cycle defrost operation for ten minutes in a day. The amount of frost varies depending on the conditions. Set it appropriately. Temperature control is suspended in addition to stop of heater and blast fan during operation.

→Refer to the page 46 for the operating instructions.

**⚠ CAUTION!**

- The temperature in furnace increases about 3°C at the defrost operation. Be careful if it affects the samples. The indicated temperature may increase more than 10°C at that time.

③ Setting of refrigeration operation mode in refrigerator (continuous/cycle):

Generation of frost can be reduced by setting the cycle operation where the refrigerator repeats operation and halt. The refrigerator operation mode has a function to set the refrigerator to continuous operation, cycle operation or halt condition. The refrigerator repeats 12-minute operation and 12-minute halt condition in the cycle operation. If the setting temperature is 10°C or below, it switches automatically to the continuous operation related to the refrigeration capacity. The refrigerator does not work regardless of setting temperature if it is set to be stopped. Set the continuous operation when considering the accuracy of temperature control important, and set the cycle operation when reducing the amount of frost at long term operation (the accuracy of temperature control lower than that in the continuous operation). The cycle operation can also prevent the samples from drying. Set the refrigerator stop if it is not necessary to be operated (it automatically stops if the setting temperature is 44°C or above).

→Refer to the page 48 for the operating instructions.

**⚠ CAUTION!**

- The frosting amount varies depending on the conditions in use even the cycle operation is set. It may be larger when operating the refrigerator for long term. In this case, defrost the refrigerator by performing the defrost operation or cycle defrost operation.

# Description and Function of Each Part

## Main Unit

IN604

### Front view

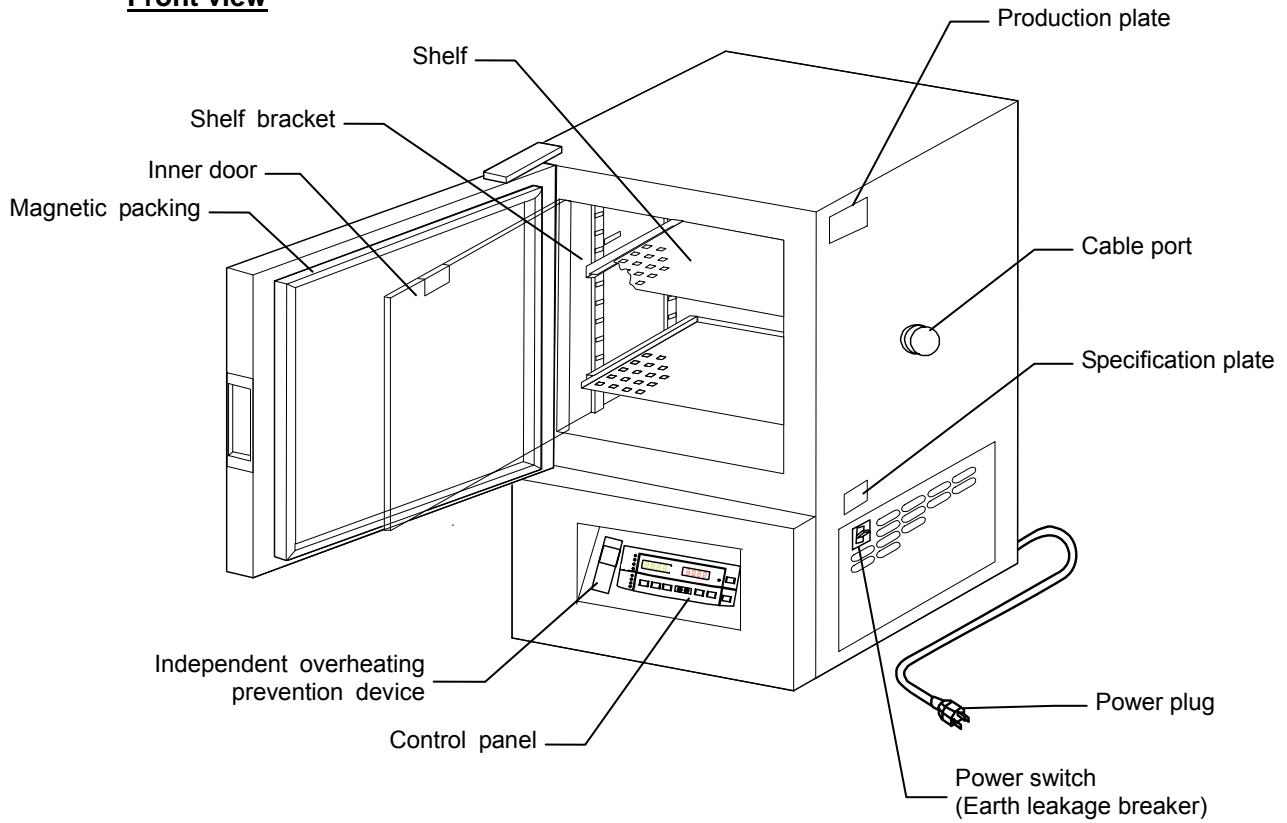

### Rear view

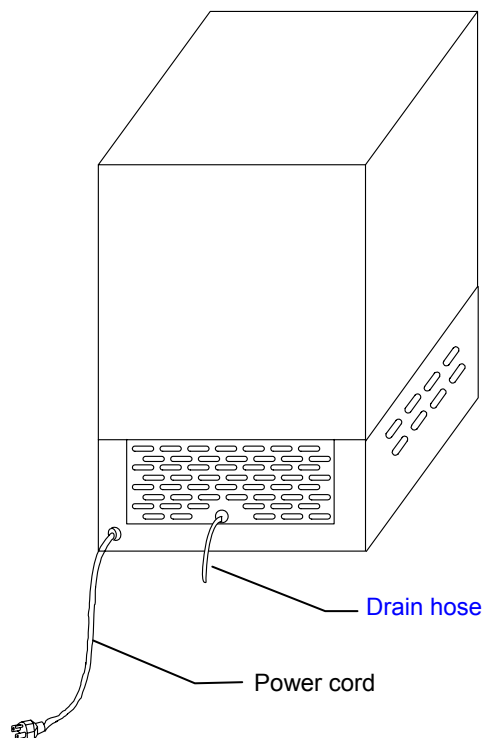

# Description and Function of Each Part

## Main Unit

IN804

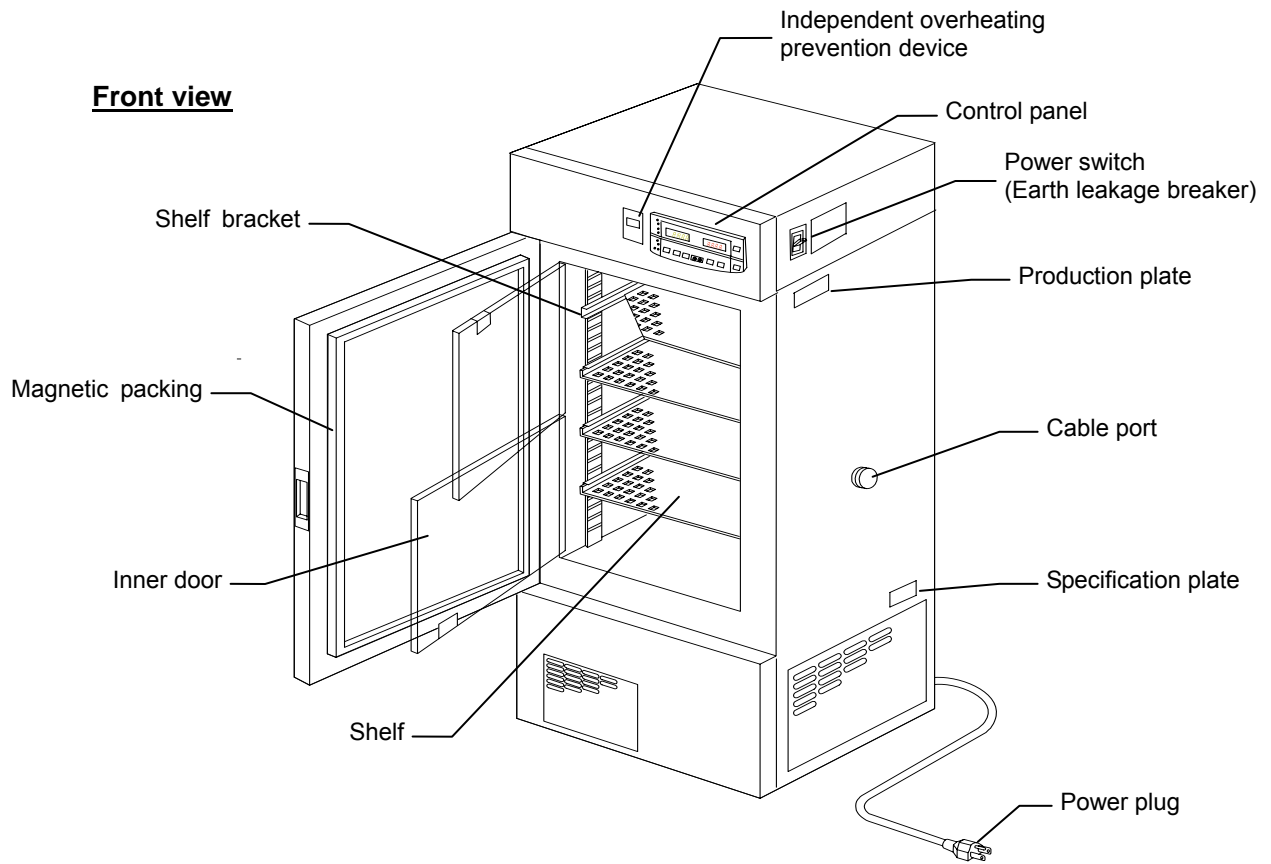

**Rear view**

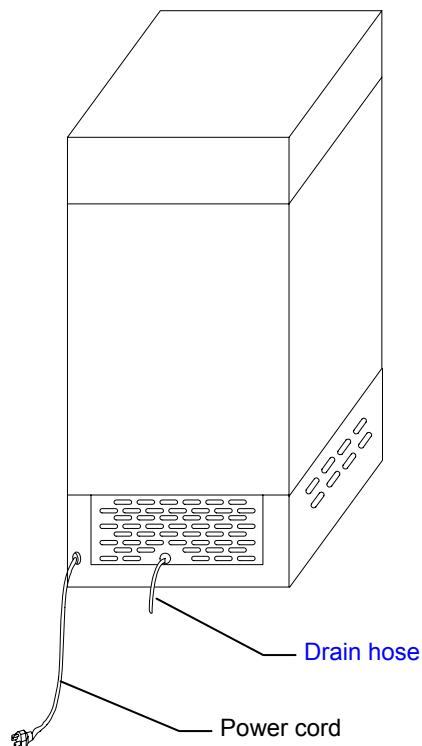

# Description and Function of Each Part

## Structure Chart

IN604

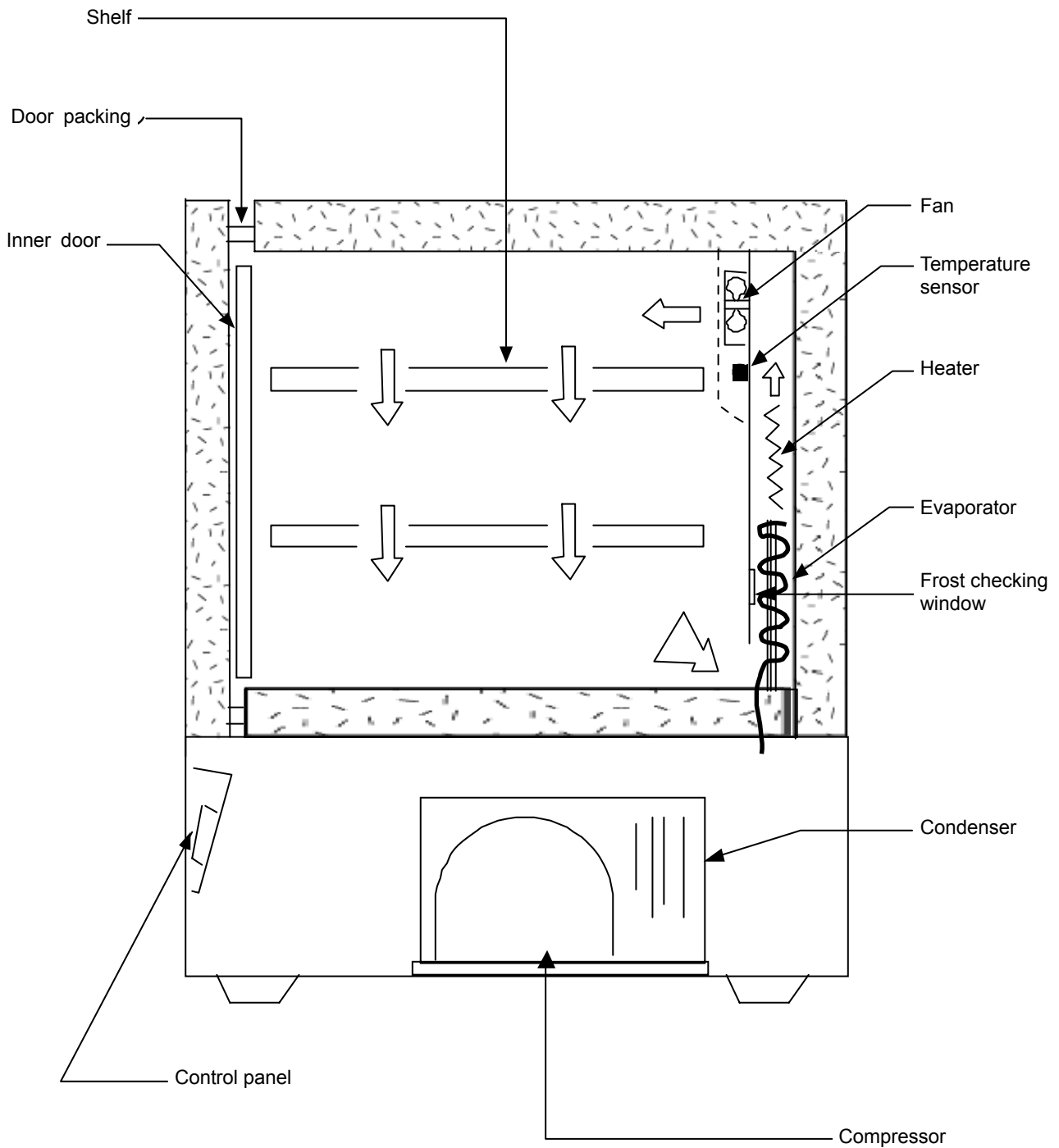

# Description and Function of Each Part

## Structure Chart

IN804

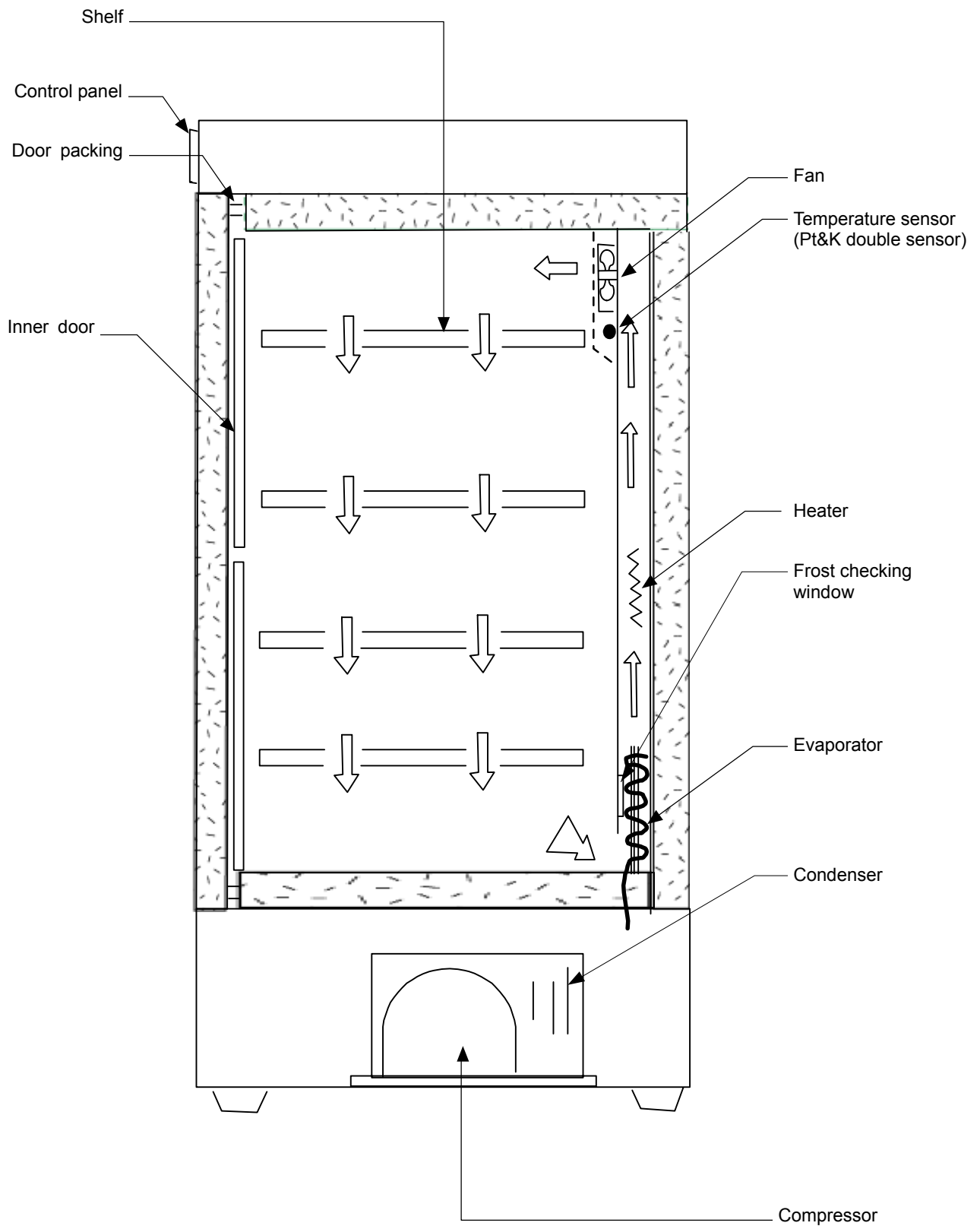



# Description and Function of Each Part

## Control Panel

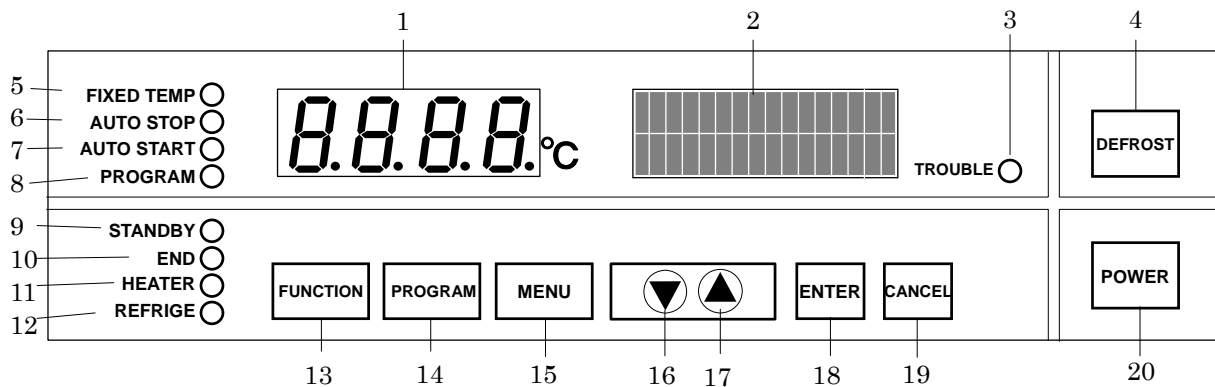

1	Main Display :	Displays the measured temperature and error code.
2	Sub Display :	Displays the operation and setting information.
3	TROUBLE Lamp :	Blinks when a trouble occurs.
4	DEFROST key :	Starts/stops the defrost operation.
5	FIXED TEMP lamp :	Lights while the fixed temperature operation is running. Blinks while the choosing operation mode.
6	AUTO STOP Lamp :	Lights while the auto stop operation is running. Blinks while choosing the operation mode.
7	AUTO START Lamp :	Lights while the auto start operation is running. Blinks while choosing the operation mode.
8	PROGRAM Lamp :	Lights while the program operation is running. Blinks while choosing the operation mode.
9	STANDBY Lamp :	Lights while the device is in standby state. Blinks while the device is in startup wait state.
10	END Lamp :	Blinks at end of the autostop or program operation.
11	HEATER Lamp :	Lights while the heater works.
12	REFRIGE Lamp :	Lights while the refrigerator works.
13	FUNCTION Key :	Starts the function menu.
14	PROGRAM Key :	Starts the program menu.
15	MENU Key :	Starts the operation menu.
16	▼(Down) Key :	Lowers down the setting value.
17	▲(Up) Key :	Rises up the setting value.
18	ENTER Key :	Settles the inputted value/item.
19	CANCEL Key :	Cancel the current inputting.
20	POWER Key :	Turns ON/OFF the power.

## Key Operation Chart of Mode Setting and Program Registering

### ► Operation procedure

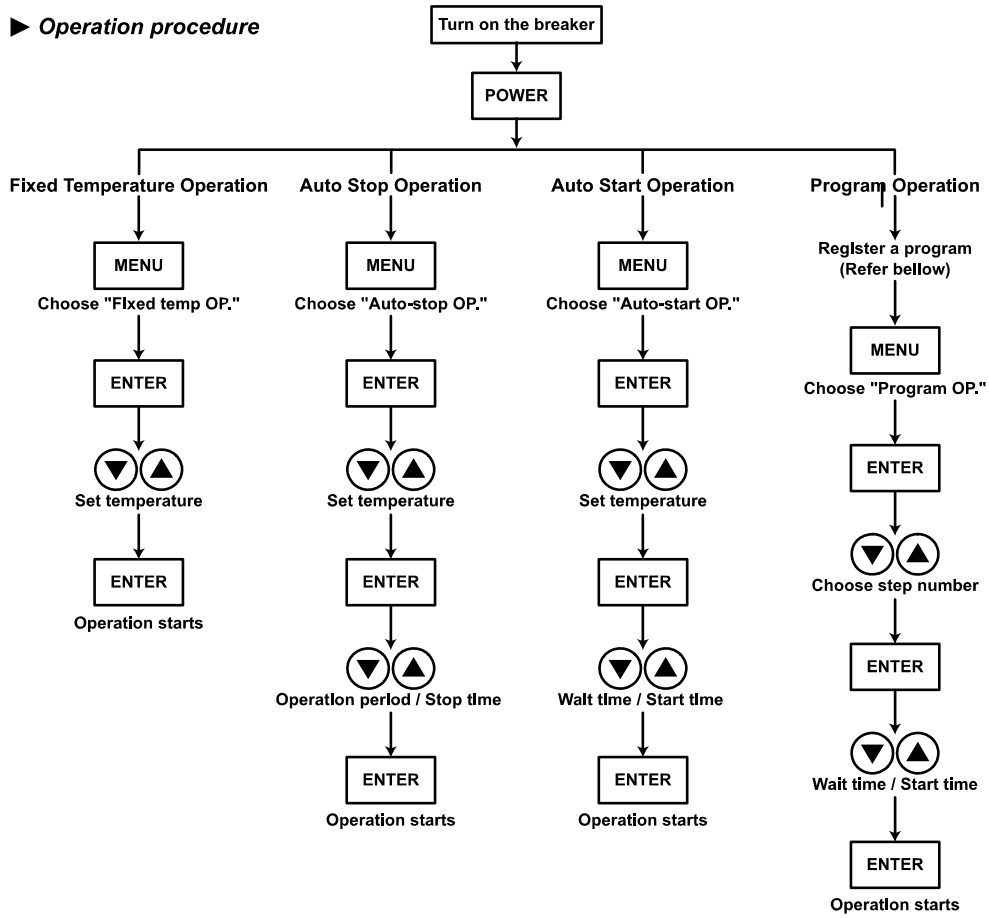

### ► How to register a program

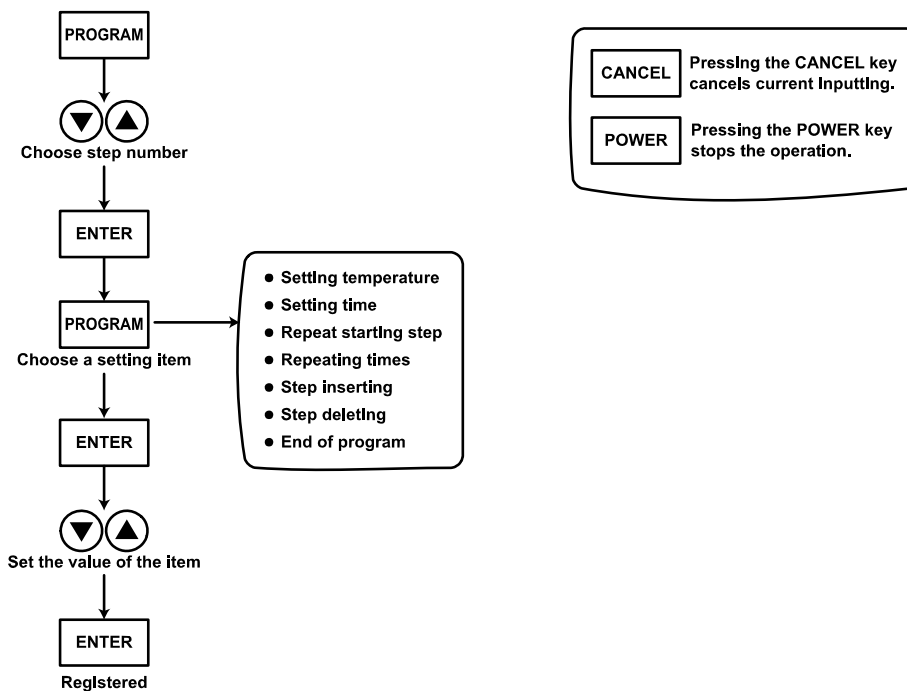

## Operation Mode and Function List

The operation mode consists of the following four modes.

No.	Name	Description	Page
1.	Fixed Temperature Operation	Controls temperature with fixed temperature.	17
2.	Auto Stop Operation	Stops operation at specified time.	20
3.	Auto Start Operation	Starts operation at specified time.	23
4.	Program Operation	Starts program operation at specified time.	25

The function menus are listed below.

Name	Function	Page
Date/Time	Sets date and time.	39
Timer Mode	Sets timer mode.	40
Operation Start Signal Input Mode	Sets operation start signal input mode.	エラー! ブックマークが定義されていません。
Operation Stop Signal Input Mode	Sets operation stop signal input mode.	エラー! ブックマークが定義されていません。
Key Lock Mode	Sets key lock mode.	41
Buzzer Mode	Sets buzzer mode.	42
Calibration Offset	Sets calibration offset temperature.	44
Integrating Operation Time	Displays integrating operation time.	45
Defrost Operation Mode	Sets defrost operation mode of refrigerator.	46
Cycle Defrost Operation Time	Sets cycle defrost operation time of refrigerator.	47
Refrigerator Operation Mode	Sets operation mode of refrigerator.	48

Communication Lockout Mode	Sets communication lockout mode.	49
----------------------------	----------------------------------	----

- ❖ Operation start signal input mode:  
When it is set to on, the unit starts operation after it receives the operation start signal in each mode.
- ❖ Operation stop signal input mode:  
When it is set to on, the unit stops operation after it receives the operation stop signal during operation in each mode.

## Fixed Temperature Operation

Start the operation from turning on the power shown in the figure, and continue the operation under the setting temperature unless turning off the power.

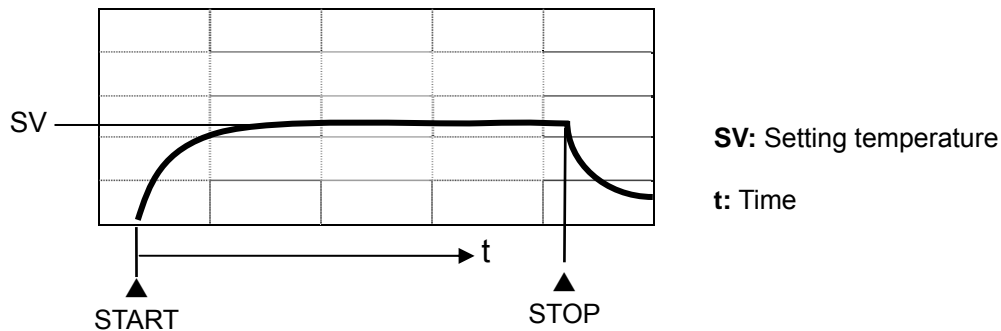

### Setting of the Fixed Temperature Operation

#### 1 Turn on the power

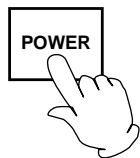

- Turn on the power switch of the unit (earth leakage breaker). Pressing the POWER key turns on the power. The Main Display indicates the temperature in furnace. The Sub Display indicates "Standby" and the STANDBY lamp lights on. (Hereafter, this state is called the "standby state".)

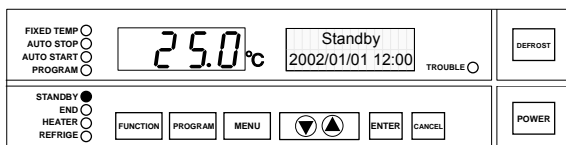

#### 2 Select operation mode

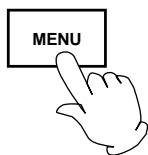

- ① Pressing the MENU key displays the operation mode selection screen.
  - ② The Sub Display on the operation mode selection screen displays the name of operation mode currently selected with blinking. The corresponding operation mode lamp blinks at the same time.
  - ③ Keep pressing the MENU key until the fixed temperature operation mode is displayed.
  - ④ Press the ENTER key. The fixed temperature operation mode is decided.
- ❖ The fixed temperature operation is selected at the initial setting of unit. The operation mode carried out last is selected in case other than it.

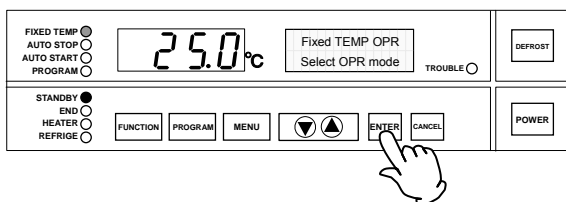

## Fixed Temperature Operation

### 3 Set temperature

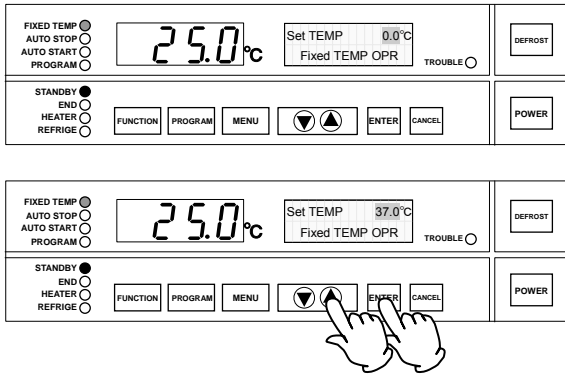

- ① The setting temperature input screen is displayed. The Sub Display indicates "Set TEMP" and the numeric character that indicates temperature blinks.
- ② Set the temperature using the "▲▼".
- ③ Press the ENTER key to decide the temperature and start the fixed temperature operation.

#### ⚠ CAUTION!

- ❖ The refrigerator operation can not be performed again for five minutes just after an operation stop. The refrigerator has been in the standby state and the REFRIGE lamp blinks during the period.

### 4 Start operation

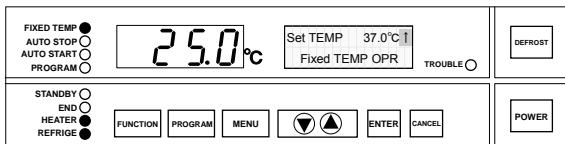

- ① The blinking FIXED TEMP lamp lights on when the fixed temperature operation starts. The unit starts to control temperature according to the setting temperature. The HEATER lamp lights on when the heater is on and The REFRIGE lamp lights on when the refrigerator is on.
- ② The Sub Display displays the setting temperature. The arrow which indicates the state of temperature control is also displayed with blinking. The direction of arrow shows as follows depending on the relation between the setting temperature at operation start and that in furnace.

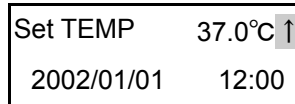

(When setting temperature is higher than temperature in furnace)

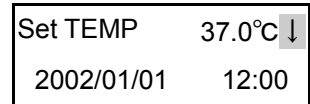

(When setting temperature is lower than temperature in furnace)

- ③ The direction of arrow shows as shown below when the temperature in furnace reaches to within  $\pm 1.0^{\circ}\text{C}$  of setting temperature.

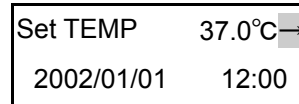

(When temperature in furnace reaches to around setting temperature)

- ④ Press the POWER key to stop operation.

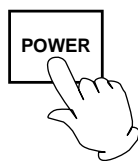

## Fixed Temperature Operation

### 5 Vary the temperature

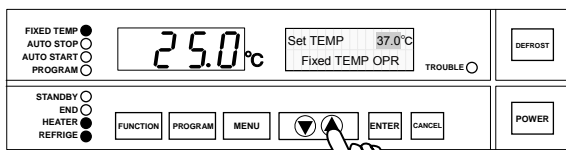

① Make the setting temperature blinking using the "▲▼" during the fixed temperature operation.

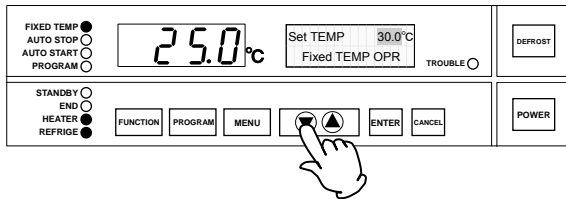

② Vary the temperature using the "▲▼".

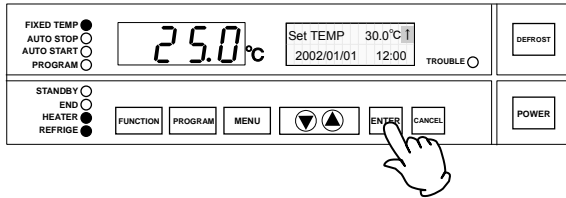

③ Press the ENTER key to decide the temperature. The fixed temperature operation continues under the new setting temperature.

## Auto Stop Operation

As shown in the following figure, the device stops operating automatically by setting the timer.

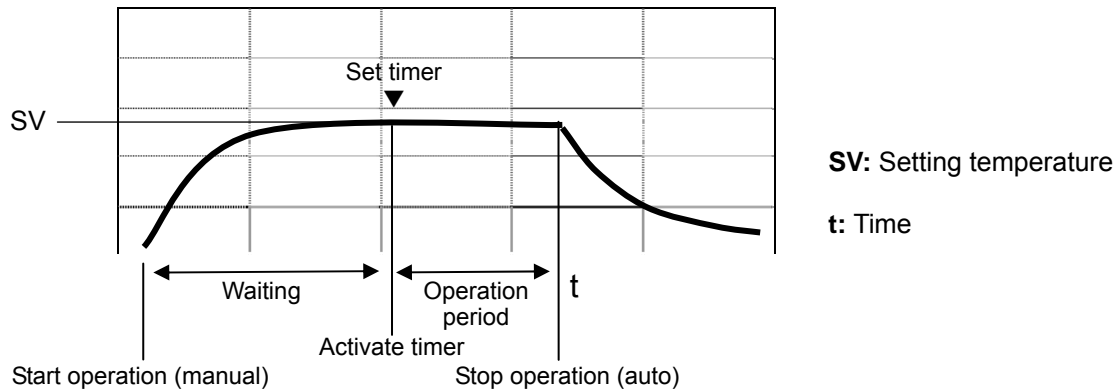

### Setting of the Auto Stop Operation

#### 1 Turn on the power

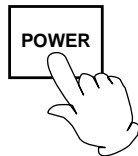

- Turn on the power switch of the unit (earth leakage breaker). Pressing the POWER key turns on the power. The Main Display indicates the temperature in furnace. The Sub Display indicates "Standby" and the STANDBY lamp lights on.

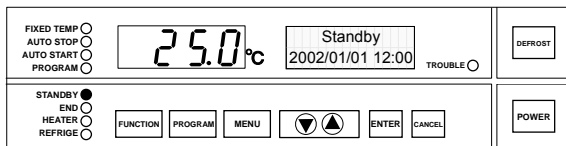

#### 2 Select operation mode

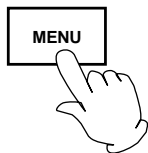

- ① Pressing the MENU key displays the operation mode selection screen.
  - ② The Sub Display on the operation mode selection screen displays the name of operation mode currently selected with blinking. The corresponding operation mode lamp blinks at the same time.
  - ③ Keep pressing the MENU key until the auto stop operation mode is displayed.
  - ④ Press the ENTER key. The auto stop operation mode is decided.
- ❖ The fixed temperature operation is selected at the initial setting of unit. The operation mode carried out last is selected in case other than it.

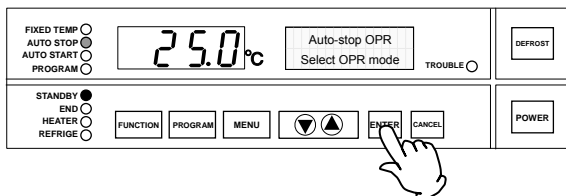



## Auto Stop Operation

### 3 Set temperature and operation period/stop time.

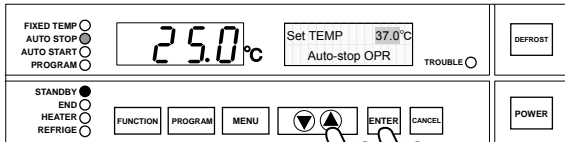
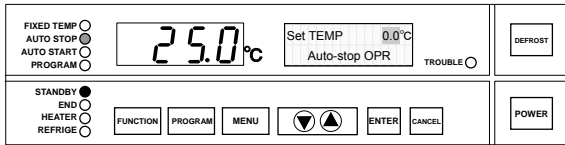

① The setting temperature input screen is displayed. The Sub Display indicates "Set TEMP" and the numeric character that indicates temperature blinks.

② Set the temperature using the "▲▼".

③ Press the ENTER key to decide the temperature.

④ The operation period/stop time input screen is displayed after the setting temperature is decided.

Display the period/time using the "▲▼".

Input the operation period when the setting of timer mode shows "Time". Input the operation stop time when it shows "Clock".

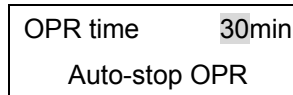

(Operation period edition screen)

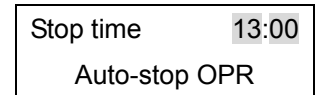

(Operation stop time edition screen)

- The display style of operation period varies depending on the range of time to be displayed.

Time Range	Indication
0minute to 59minutes	0min to 59min
1hour to 99hours59minutes	1h00m to 99h59m

- The input range of operation stop time is always from 0:00 to 23:59.
- ❖ Pressing the CANCEL key quit the setting of auto stop operation.

## Auto Stop Operation

### 4 Start operation

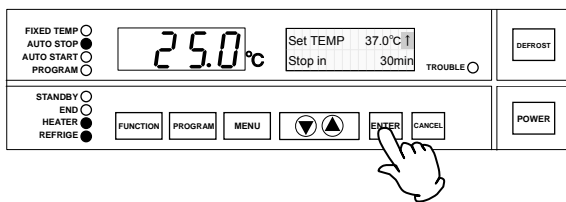

① Press the ENTER key to decide the setting and the auto stop operation starts. The blinking AUTO STOP lamp lights on and the Sub Display displays the setting temperature and residual time to operation stop.

② The countdown of timer is suspended when the temperature in furnace is out of the range of "within  $\pm 1^\circ\text{C}$  to the setting temperature". In this case, the Sub Display displays "Wait" with blinking. The time display on the right side of "Wait" shows the total waiting time in operation.

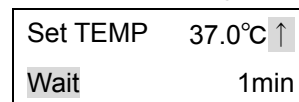

(Waiting screen)

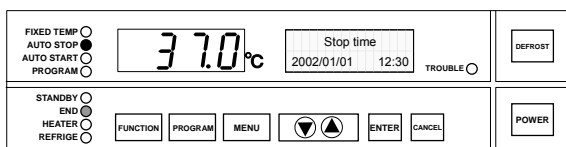

③ The operation stops when the residual time counts zero. The END lamp blinks and the Sub Display displays the operation finish time when the operation stops.

❖ The wait function is not activated when the auto stop operation is carried out with "Clock" mode. The operation stops at specified time.

④ Press the POWER key to quit operation.

## Auto Start Operation

As shown in the following figure, this mode is applied to the device for starting the operation after the specified time (hours) automatically. Note that the device does not stop the operation automatically. Stop the operation by manual without fail.

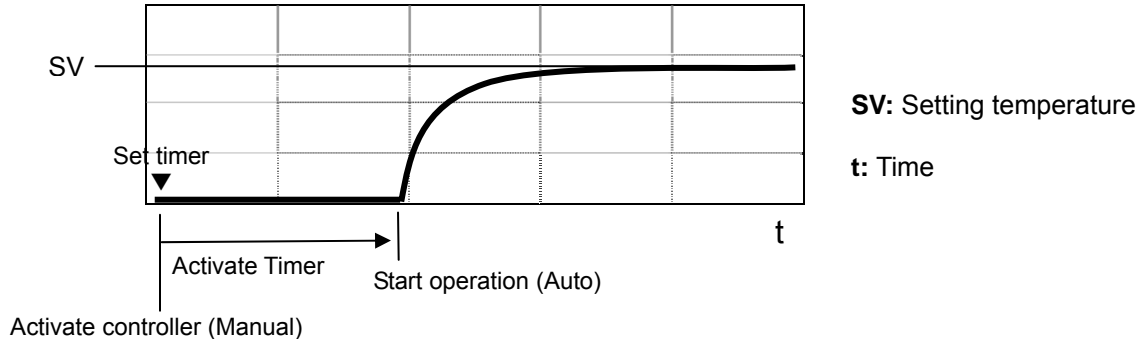

## Setting of the Auto Start Operation

### 1 Turn on the power

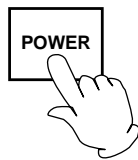

- Turn on the power switch of the unit (earth leakage breaker). Pressing the POWER key turns on the power. The Main Display indicates the temperature in furnace. The Sub Display indicates "Standby" and the STANDBY lamp lights on.

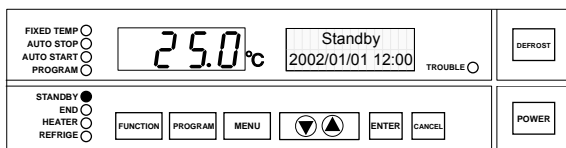

### 2 Select operation mode

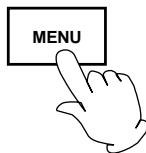

- ① Pressing the MENU key displays the operation mode selection screen.
  - ② The Sub Display on the operation mode selection screen displays the name of operation mode currently selected with blinking. The corresponding operation mode lamp blinks at the same time.
  - ③ Keep pressing the MENU key until the auto start operation mode is displayed.
  - ④ Press the ENTER key. The auto start operation mode is decided.
- ❖ The fixed temperature operation is selected at the initial setting of unit. The operation mode carried out last is selected in case other than it.

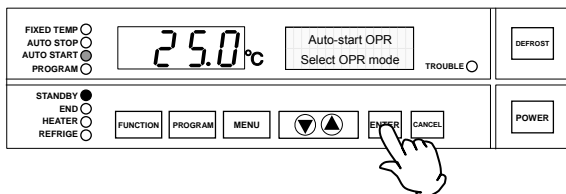

## Auto Start Operation

### 3 Set temperature and start wait period/time

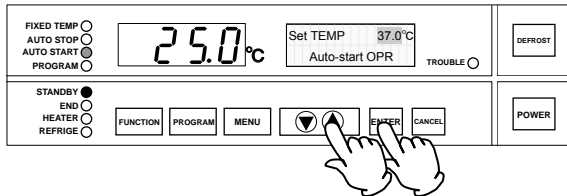
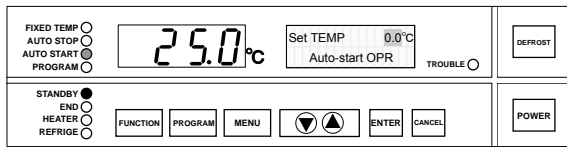

① The setting temperature input screen is displayed. The Sub Display indicates "Set TEMP" and the numeric character that indicates temperature blinks.

② Set the temperature using the "▲▼".

③ Press the ENTER key to decide the temperature.

④ The operation start wait period/time input screen is displayed after the setting temperature is decided.

Display the operation start wait period/time using the "▲▼".

Input the operation start wait period when the setting of timer mode shows "Time". Input the operation start time when it shows "Clock".

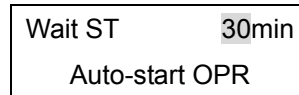

(Operation start wait period edition screen)

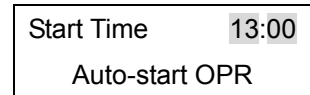

(Operation start time edition screen)

- The display style of operation start wait period varies depending on the range of time to be displayed.

Time Range	Indication
0minute to 59minutes	0min to 59min
1hour to 99hours59minutes	1h00m to 99h59m

- The input range of operation start time is always from 0:00 to 23:59.
- ❖ Pressing the CANCEL key quit the setting of auto start operation.

### 4 Start operation

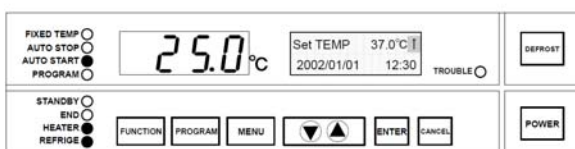
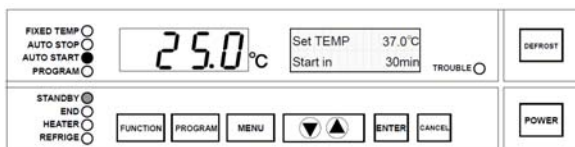

① Press the ENTER key to decide the operation start wait period/time. The unit enters to auto start operation wait state. The blinking AUTO START lamp lights on and the STANDBY lamp blinks instead in this state. The Sub Display displays the setting temperature and residual time to operation start.

② The operation starts when the residual time counts zero. The STANDBY lamp lights off and the Sub Display displays the same subject as in the fixed temperature operation after the operation starts.

③ Press the POWER key to cancel or quit the wait state.

## Program Operation

As shown in the figure, this mode is used for running the device under the setting program.

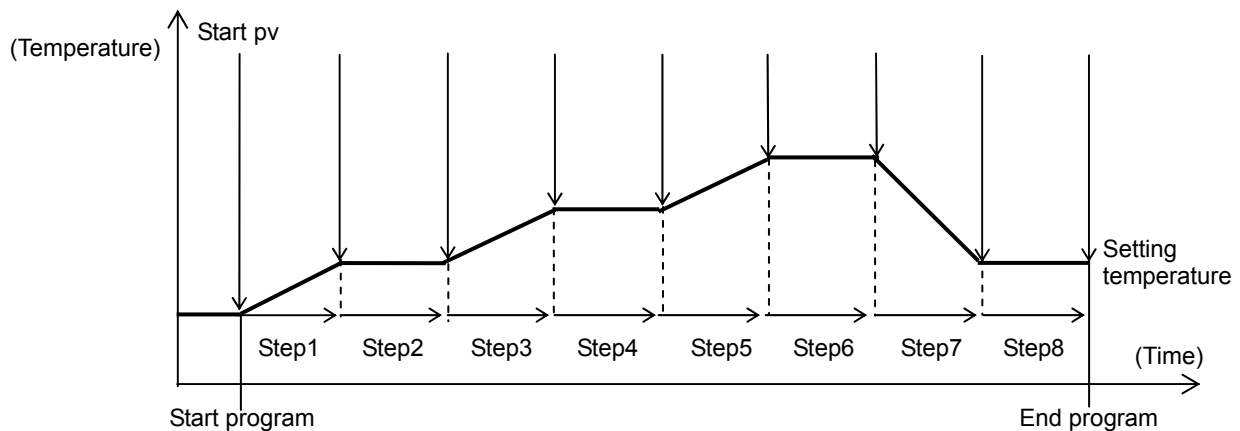

## Setting of the Program Operation

### 1 Turn on the power

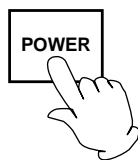

- Turn on the power switch of the unit (earth leakage breaker). Pressing the POWER key turns on the power. The Main Display indicates the temperature in furnace. The Sub Display indicates "Standby" and the STANDBY lamp lights on.

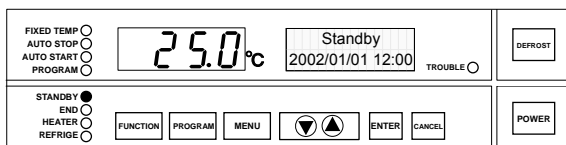

❖ Program registration using PROGRAM key is necessary before starting program operation.

### 2 Select operation mode

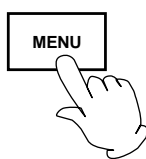

- ① Pressing the MENU key displays the operation mode selection screen.
  - ② The Sub Display on the operation mode selection screen displays the name of operation mode currently selected with blinking. The corresponding operation mode lamp blinks at the same time.
  - ③ Keep pressing the MENU key until the program operation mode is displayed.
  - ④ Press the ENTER key. The program operation mode is decided.
- ❖ The fixed temperature operation is selected at the initial setting of unit. The operation mode carried out last is selected in case other than it.

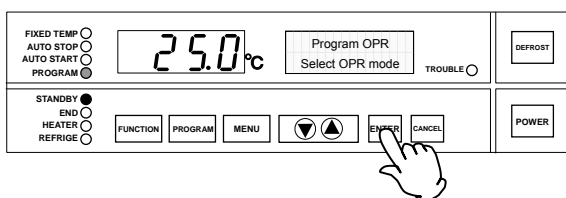

## Program Operation

### 3 Set step number and start wait period/ time

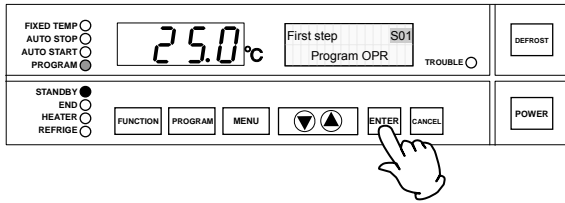

- ① The initiating step input screen is displayed. The Sub Display displays "First step" and the step number blinks.
- ② Select the step number using the "▼▲" and then check it using the ENTER key.
  - ❖ The "steps that are not set" and "step within repeat" are not displayed. If no program is registered (no steps are used), the buzzer sounds with a message on the Sub Display. In this case, register program using the PROGRAM key and start the step again.

NO program  
Registered

(Display in case no program is registered)

- ③ The operation start wait period/time input screen is displayed after the step number is decided. Display the operation start wait period/time using the "▲▼".  
Input the operation start wait period when the setting of timer mode shows "Time". Input the operation start time when it shows "Clock".

Wait ST      30min  
Program OPR

(Operation start wait period edition screen)

Start Time    13:00  
Program OPR

(Operation start time edition screen)

- ❖ Pressing the CANCEL key quit the setting of auto start operation.

## Program Operation

### 4 Start operation

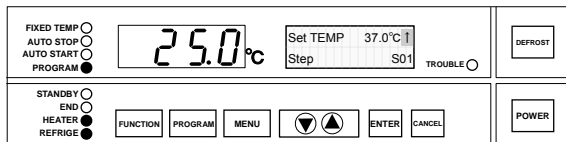
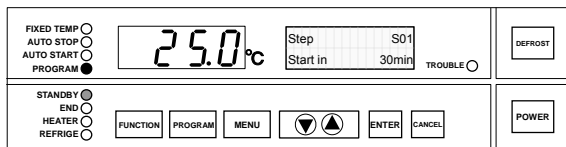

① Press the ENTER key to decide the operation start wait period/time. The unit enters to program operation wait state. The blinking PROGRAM lamp lights on and the STANDBY lamp blinks instead in this state. The Sub Display displays the step number and residual time to operation start.

② The operation starts when the residual time counts zero. The STANDBY lamp lights off and the Sub Display displays the executing step number and the setting temperature after the operation starts.

③ The following screens are displayed in sequence during operation.

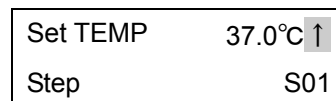

(Executing step number)

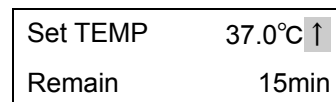

(Remaining time)

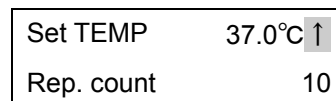

(Residual count of repeat:  
displayed during repeat only)

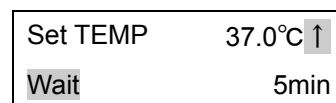

(Waiting state: displayed  
during wait only)

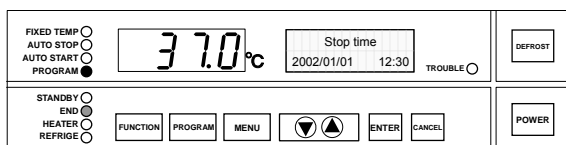

④ The END lamp blinks and the Sub Display displays the operation finish time when the operation stops.

⑤ Press the POWER key to cancel the operation or quit the wait state.

## Input Program

### 1 Select program function

- Check that the power is turned on.

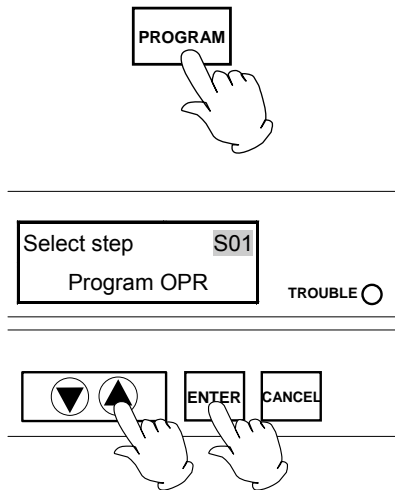

- ① Press the PROGRAM key. The program menu starts and step number selection screen is displayed. Press the "▼▲". The registered step numbers and the smallest number of un-used step are displayed in sequence. Select the step number among them.
  - ❖ The "S01" is displayed when no program is registered. In this case, the "▼▲" are invalid.
- ② Press the ENTER key. The selected step number is decided and the setting item selection screen is displayed. The "Set TEMP" is displayed first.
- ③ Press the CANCEL key to cancel the program menu.

### 2 Edit step

- The following four setting items are included in a step.

Setting item	Setting range
<b>Setting temperature</b>	Setting temperature range by product type
<b>Setting time</b>	0 minute to 999 hour and 59 minutes, End
<b>Repeat initiating step</b>	None, Registered step numbers 1 to 32
<b>Repeat count</b>	1 to 9999, Infinity

- The unit operates with fixed rate inclination if the "START TEMP" and the "Set Temp" are different. It enters into "Wait" if the temperature does not reach to the setting temperature within a setting time.

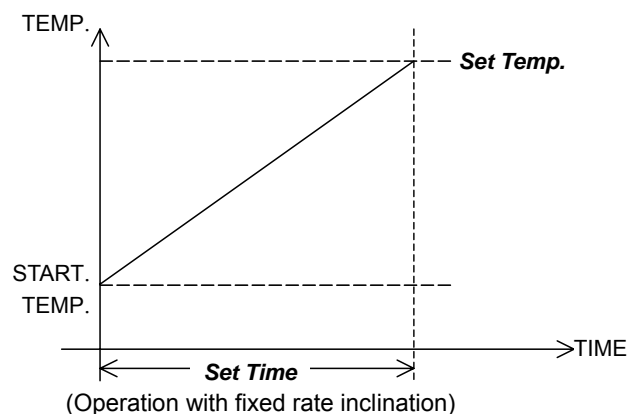



## Input Program

2

- The temperature is kept constant till the end of setting time when the "START TEMP" and the "Set Temp" are the same. The unit enters into "Wait" and measurement of residual time is suspended when the temperature in furnace is within  $\pm 1^\circ\text{C}$  to the setting temperature.

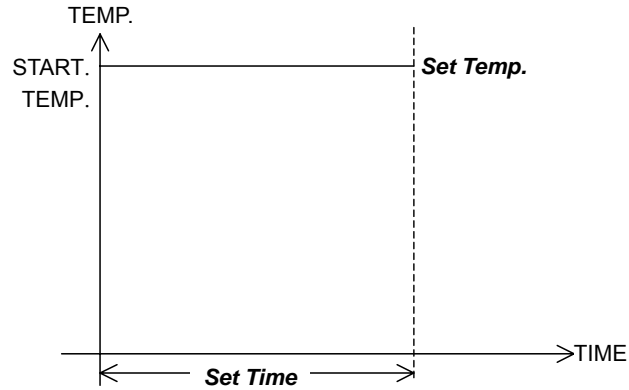

- The unit operates with full-power from the "START TEMP" to the "Set Temp" when the period is set to 0 minute. It keeps the "Wait" state until the temperature in furnace is within  $\pm 1^\circ\text{C}$  to the setting temperature.

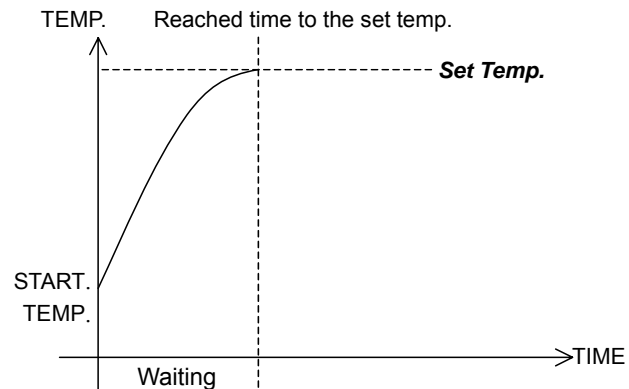

- The conception of repeat is shown in the figure below. The first operation of repeat interval is not counted as a repeat count.

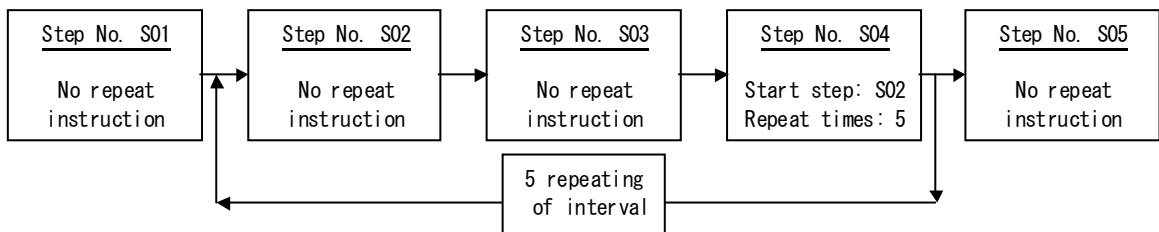

## Input Program

- 2** ① After the step number is decided, the setting item selection screen is displayed. Select the items on the Sub Display using the PROGRAM key.

No.	Item	Sub Display	Notes
1	<b>Setting temperature</b>	Set TEMP 37.0°C S01	
2	<b>Setting time</b>	Set time 0min S01	
3	<b>Repeat initiating step</b>	Rep. start S01 S01	
4	<b>Repeat count</b>	Rep. count 5 S01	
5	<b>Step insertion</b>	Insert step S01	Add a new step at the position of step currently referred to. The sequence number of each step hereafter increases by one.
6	<b>Step deletion</b>	Delete step S01	Delete the step currently referred to. The sequence number of each step hereafter decreases by one.
7	<b>Program end</b>	Program End S01	Complete program registration/edition.

- ❖ The step number currently edited is displayed on the lower column of Sub Display. The details for all registered steps in use are displayed followed by all un-used steps.
- ❖ The "Set TEMP" for the next step follows the "Program End". The screen, in this way, displays the details of respective steps in sequence. The unused steps are displayed at the end if other steps are used. The display "un-used" is added at the end of step number displayed in the lower column of Sub Display for un-used steps. All steps subsequent to the step with "un-used" are un-used steps.
- The setting items are not displayed on the screen depending on the setting conditions shown below.

Setting item	Not displayed in the following condition
<b>Setting temperature</b>	Not displayed when the setting time is set to "End".
<b>Repeat initiating step</b>	Not displayed when the period is set to "End" or when the other step is inserted in the specified repeat interval.
<b>Repeat count</b>	Not displayed when the repeat initiating step is not displayed, or "No" is set.
<b>Step insertion</b>	Not displayed when steps are left.

- ❖ It is impossible to change the content of program currently operated. Checking it is possible.

## Input Program

- 2 ② Select the "Set TEMP" and press the ENTER key. The temperature setting edition screen is displayed. The blinking " · " (cursor) goes out and the setting value blinks instead.

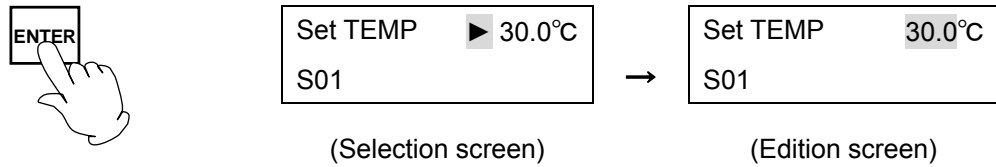

- ③ Select the temperature using "▼▲" and press the ENTER key. The setting is decided and the screen returns to the setting item selection screen.

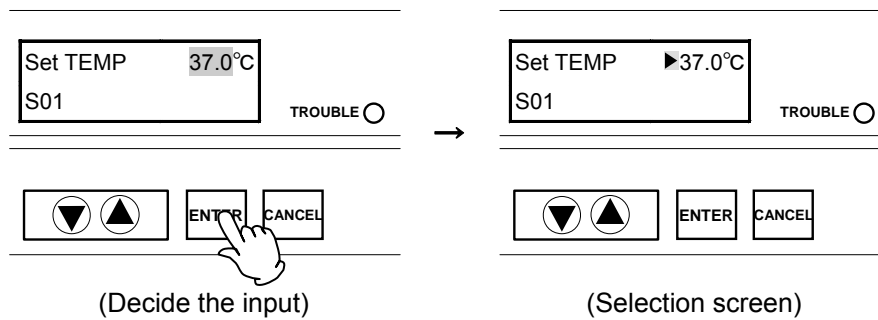

- ④ Press the CANCEL key to cancel the input. The value is cancelled and the screen returns to the setting item selection screen.

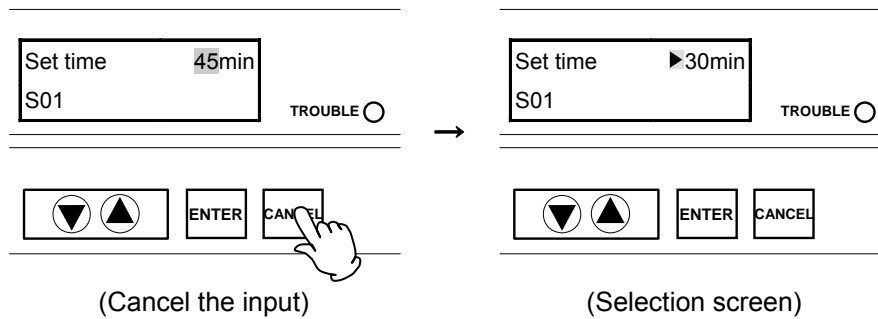

## Input Program

### 3 Insert step into the position currently displayed

① Display the "Insert step" on the setting item selection screen and then press the ENTER key. The screen returns to the setting item selection screen and the setting temperature of inserted step is displayed.

❖ The "Insert step" is not displayed if no steps are left.

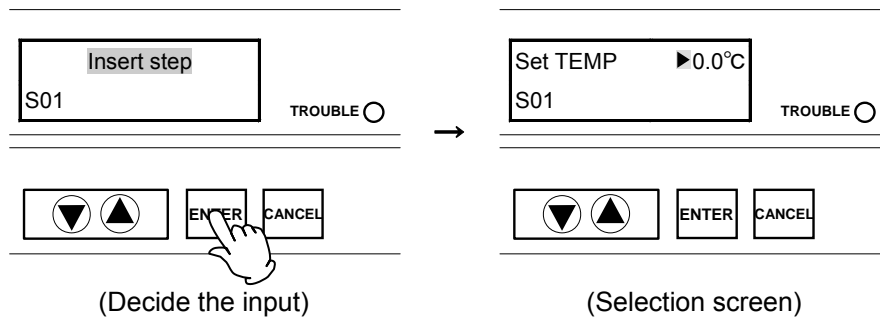

❖ The initial settings below are set in the newly inserted step. The settings of "un-used" steps displayed at the end of "Select step" are the same as that listed below.

Item	Initial setting
Setting temperature	0°C
Setting time	0 minute
Repeat initiating step	No

### 4 Add step at the end of program

① Display the setting of un-used step on the setting item selection screen and then press the ENTER key.

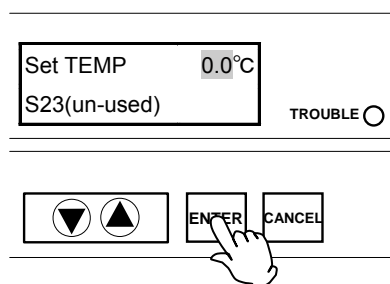

❖ The "SO1" (the first step) indicates "un-used" at the first registration of program.

❖ The items other than "Insert step", "Delete step" and "End program" can be set.

❖ The "un-used" steps are not displayed if no steps are left.

② Change the setting value and press the ENTER key.

③ The indication "un-used" on the lower column of Sub Display goes out.

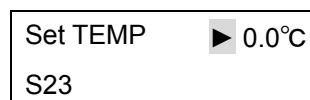

## Input Program

### 5 Delete step currently displayed

- Check that any program is registered.
- ① Select the "Delete step" and press the ENTER key.

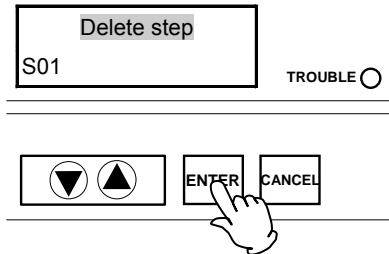

- ❖ Pressing the "CANCEL key before pressing the ENTER quit the deletion.

### 6 End program edition

- ① Select the "Program End" on the setting item selection screen and press the ENTER key. The edited program is saved and the edition is completed.

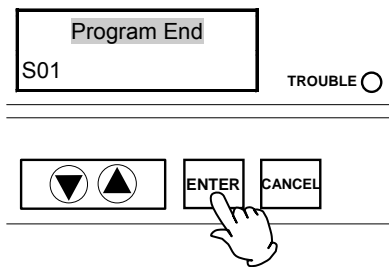

### 7 Cancel edited program

- Press the CANCEL key on the step number selection screen to cancel the edited program, including insertion, deletion and addition of step.
- Press the CANCEL key on the setting item selection screen to return to the step number selection screen. Press it again to cancel the edited program.

## Program Creation Example

- The program pattern below is explained as an example.

Step No.	Setting Temp.	Setting Time	Repeat Start	Repeat Count
S01	50.0°C	30min	No	-
S02	20.0°C	0min	No	-
S03	°C-10.0	15min	S02	1
S04	-	End	-	-

<b>1</b>	Press the PROGRAM key to display the step number selection screen.	
<b>2</b>	Display "S01" using the "▼▲".	
<b>3</b>	Press the ENTER key to display the "Set TEMP".	
<b>4</b>	Press the ENTER key to display the setting temperature edition screen. The cursor goes out and the setting temperature blinks.	
<b>5</b>	Set the temperature to 50°C using the "▼▲".	
<b>6</b>	Press the ENTER key to decide the temperature.	
<b>7</b>	Press the PROGRAM key to display the "Set time" selection screen.	
<b>8</b>	Press the ENTER key to display the setting period edition screen. The cursor goes out and the setting period blinks.	
<b>9</b>	Set the period to 30 min using the "▼▲".	
<b>10</b>	Press the ENTER key to decide the period.	

## Program Creation Example

11	Press the PROGRAM key to display the "Rep. start".	Rep. start <input checked="" type="checkbox"/> OFF S01
12	Press the ENTER key to display the repeat initiating step edition screen. The cursor goes out and the setting for repeat initiating step blinks.	Rep. start OFF S01
13	Set the "No" using the "▼▲".	Rep. start <input checked="" type="checkbox"/> OFF S01
14	Press the ENTER key to decide the setting.	Rep. start <input checked="" type="checkbox"/> OFF S01
15	Press the PROGRAM key until the "Set TEMP" in the Step 2 is displayed. The display on the lower column changes from "S01" to "S02" or to "S02 (un-used)".	Set TEMP <input checked="" type="checkbox"/> 0.0°C S02
16	Press the ENTER key to display the setting temperature edition screen. The cursor goes out and the setting temperature blinks.	Set TEMP 0.0°C S02
17	Set the temperature to 20°C using the "▼▲".	Set TEMP 20.0°C S02
18	Press the ENTER key to decide the temperature.	Set TEMP <input checked="" type="checkbox"/> 20.0°C S02
19	Press the PROGRAM key to display the "Set time" selection screen.	Set time <input checked="" type="checkbox"/> 0min S02
20	Press the ENTER key to display the setting period edition screen. The cursor goes out and the setting period blinks.	Set time 0min S02
21	Set the period to 0 min using the "▼▲".	Set time 0min S02
22	Press the ENTER key to decide the period.	Set time <input checked="" type="checkbox"/> 0min S02
23	Press the PROGRAM key to display the "Rep. start".	Rep. start <input checked="" type="checkbox"/> OFF S02
24	Press the ENTER key to display the repeat initiating step edition screen. The cursor goes out and the setting for repeat initiating step blinks.	Rep. start OFF S02

## Program Creation Example

<b>25</b>	Set the "No" using the "▼▲".	Rep. start   ▶ OFF S02
<b>26</b>	Press the ENTER key to decide the setting.	Rep. start   ▶ OFF S02
<b>27</b>	Press the PROGRAM key until the "Set TEMP" in the Step 3 is displayed. The display on the lower column changes from "S02" to "S03" or to "S03 (un-used)".	Set TEMP   ▶ 0.0°C S03
<b>28</b>	Press the ENTER key to display the setting temperature edition screen. The cursor goes out and the setting temperature blinks.	Set TEMP    0.0°C S03
<b>29</b>	Set the temperature to -10°C using the "▼▲".	Set TEMP   -10.0°C S03
<b>30</b>	Press the ENTER key to decide the temperature.	Set TEMP   ▶ -10.0°C S03
<b>31</b>	Press the PROGRAM key to display the "Set time" selection screen.	Set time    ▶ 0min S03
<b>32</b>	Press the ENTER key to display the setting period edition screen. The cursor goes out and the setting period blinks.	Set time    0min S03
<b>33</b>	Set the period to 15 min using the "▼▲".	Set time    15min S03
<b>34</b>	Press the ENTER key to decide the period.	Set time    ▶ 15min S03
<b>35</b>	Press the PROGRAM key to display the "Rep. start".	Rep. start   ▶ OFF S03
<b>36</b>	Press the ENTER key to display the repeat initiating step edition screen. The cursor goes out and the setting for repeat initiating step blinks.	Rep. start   OFF S03
<b>37</b>	Set "S02" using the "▼▲".	Rep. start   S02 S03
<b>38</b>	Press the ENTER key to decide the setting.	Rep. start   ▶ S02 S03



## Program Creation Example

<b>39</b>	Press the PROGRAM key to display the "Rep. count".	Rep.count   ► Endless S03
<b>40</b>	Press the ENTER key to display the setting for repeat count edition screen. The cursor goes out and the repeat count blinks.	Rep. count   Endless S03
<b>41</b>	Set "1" using the "▼▲".	Rep. count   1 S03
<b>42</b>	Press the ENTER key to decide the setting.	Rep.count   ► 1 S03
<b>43</b>	Press the PROGRAM key until the "Set time" in the Step 4 is displayed. The display on the lower column changes from "S03" to "S04" or to "SO4 (un-used)".	Set time   ► 0min S04
<b>44</b>	Press the ENTER key to display the setting period edition screen. The cursor goes out and the setting period blinks.	Set time   0min S04
<b>45</b>	Display the "End" using the "▼▲".	Set time   End S04
<b>46</b>	Press the ENTER key to decide the setting.	Set time   ► End S04
<b>47</b>	Press the PROGRAM key until the "Program End" in the Step 4 is displayed.	Program End S04
<b>48</b>	Press the ENTER key to register the program and return to the standby state.	Standby 2002/01/01   12:00

## Set Clock

- ❖ The clock is not set at factory shipment. Set it with your watch or time tone before using the unit.
- ❖ The setting for clock can not be changed at the operation start waiting state in the auto start mode/program mode, or during operation. Press the POWER key and stop operation to change it.

### 1 Select the item in function menu

- Check that the power is turned on.

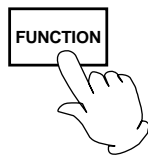

- ① Press the FUNCTION key. The function menu starts and the Sub Display displays the items. Select the item using the FUNCTION key.

### 2 Select the setting item

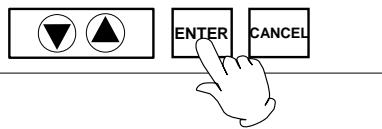
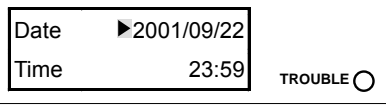

- ① Display the "Date" and "Time" using the FUNCTION key. The date and time currently set are displayed.

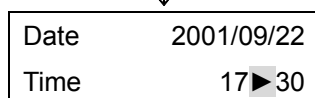
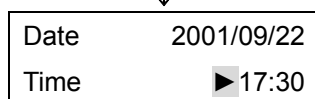
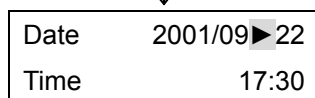
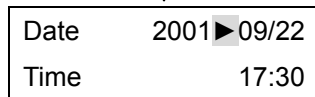

- ② The "·" (cursor) moves to "year", "month", "date", "hour" and "minute" in this order when the FUNCTION key is pressed. Select the item to be set and press the ENTER key.

## Set Clock

### 3 Input value

Date	2001/09/22
Time	17:30

↓

Date	2002/09/22
Time	17:30

- ① The "·" (cursor) goes out and the current value blinks instead. Display the desired value using the "▼▲".

### 4 Set clock

Date	▶2002/09/22
Time	23:59

TROUBLE ○

---

▼▲	ENTER	CANCEL
----	-------	--------



- ① Press the ENTER key. The setting is decided and the function menu selection screen is displayed.

## Set the Timer Mode

❖ Changes in timer mode are not reflected in the operation currently carried out in the following state of unit; operation start waiting state in the auto start mode, during auto stop mode operation, and operation start waiting state in the program operation mode. The changes are reflected on and after the next operation.

### 1 Select the item in function menu

- Check that the power is turned on.

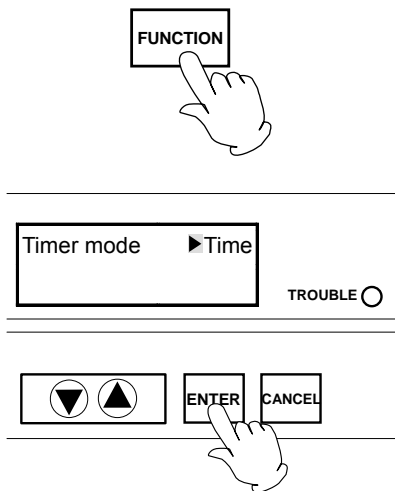

① Press the FUNCTION key. The function menu starts and the Sub Display displays the items. Select the item using the FUNCTION key.

② Display the "Timer mode" and press the ENTER key.

❖ Press the CANCEL key to cancel the function menu.

### 2 Select mode

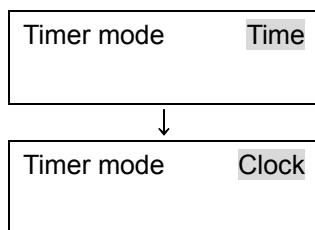

① The "·" (cursor) goes out and the mode currently selected blinks instead. Display the "Time" or "Clock" using the "▼▲".

### 3 Set timer mode

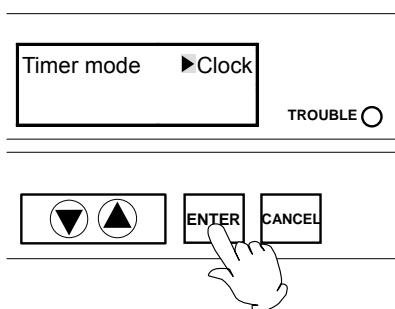

① Press the ENTER key. The timer mode is decided and the function menu selection screen is displayed.

## Set the Key Lock Mode

### 1 Select the item in function menu

- Check that the power is turned on.

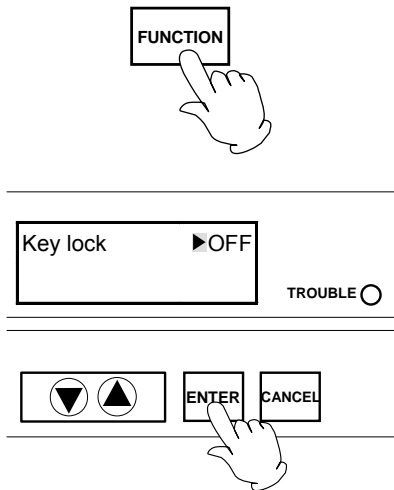

① Press the FUNCTION key. The function menu starts and the Sub Display displays the items. Select the item using the FUNCTION key.

② Display the "Key lock" and press the ENTER key.  
❖ Press the CANCEL key to cancel the function menu.

### 2 Select mode

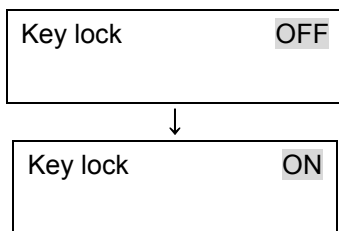

① The "·" (cursor) goes out and the mode currently selected blinks instead. Display the "ON" or "OFF" using the "▼▲".

### 3 Set key lock mode

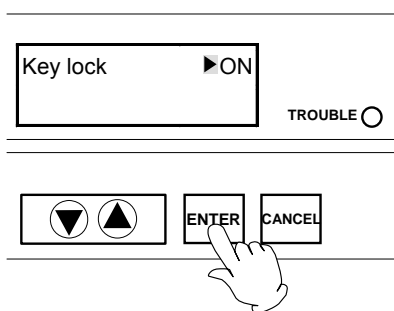

① Press the ENTER key. The key lock mode is decided and the function menu selection screen is displayed.

❖ Only the POWER key and change of key lock mode are available in key lock state. If any operation except that is done, the Sub Display displays the "Key lock" with the alarm sound.

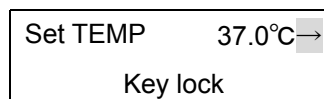

(Screen of under the fixed temperature operation)

## Set the Buzzer Mode

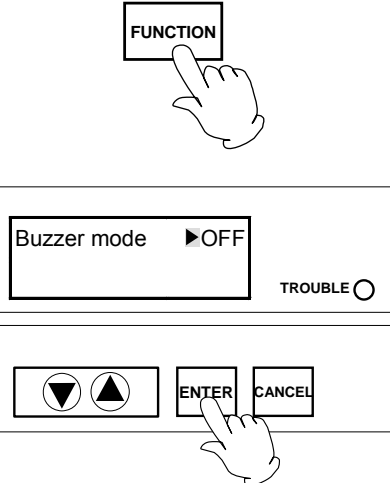
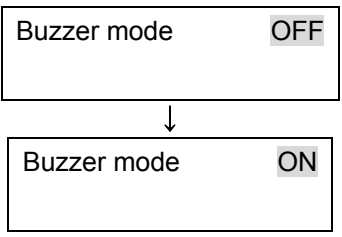
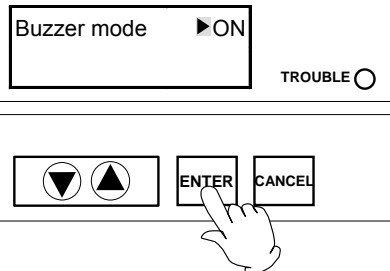
<p><b>1</b></p>	<p><b>Select the item in function menu</b></p> <ul style="list-style-type: none"> <li>• Check that the power is turned on.</li> </ul> 	<ul style="list-style-type: none"> <li>① Press the FUNCTION key. The function menu starts and the Sub Display displays the items. Select the item using the FUNCTION key.</li> <li>② Display the "Buzzer mode" and press the ENTER key.</li> <li>❖ Press the CANCEL key to cancel the function menu.</li> </ul>
<p><b>2</b></p>	<p><b>Select mode</b></p> 	<ul style="list-style-type: none"> <li>① The "·" (cursor) goes out and the mode currently selected blinks instead. Display the "ON" or "OFF" using the "▼▲".</li> </ul>
<p><b>3</b></p>	<p><b>Set buzzer mode</b></p> 	<ul style="list-style-type: none"> <li>① Press the ENTER key. The buzzer mode is decided and the function menu selection screen is displayed.</li> <li>❖ The buzzer at auto stop and at the end of program operation does not sound when the buzzer mode is turned to "OFF". It sounds when the safety device works because a trouble occurs on the unit.</li> </ul>

## Calibration Offset Function

- ❖ Calibration offset is a function which corrects the difference between the temperature in furnace and that of controller (sensor temperature) if arises. The function parallel corrects the difference either to the plus or minus side within the whole temperature range of unit.

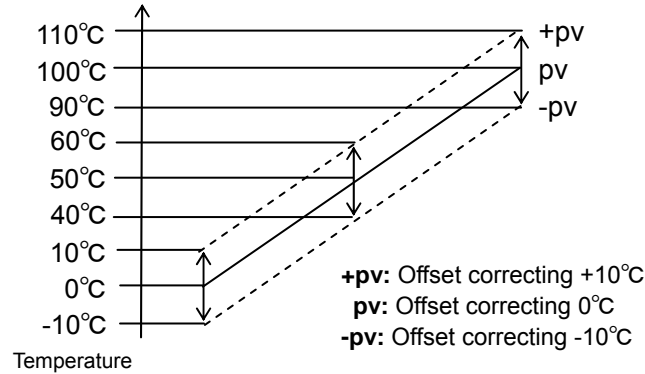

### 1 Select the item in function menu

- Check that the power is turned on.

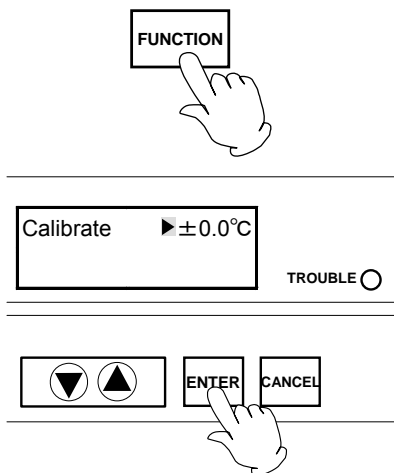

- ① Press the FUNCTION key. The function menu starts and the Sub Display displays the items. Select the item using the FUNCTION key.
- ② Display the "Calibrate" and press the ENTER key.
  - ❖ Press the CANCEL key to cancel the function menu.

### 2 Input value

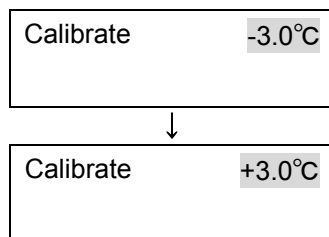

- ① The "·" (cursor) goes out and the current offset temperature blinks instead. Select the "-" to lower the temperature (to rise that in furnace), or "+" to rise it (to lower that in furnace) to display the offset temperature using the "▼▲".

## Calibration Offset Function

### 3 Set calibration offset

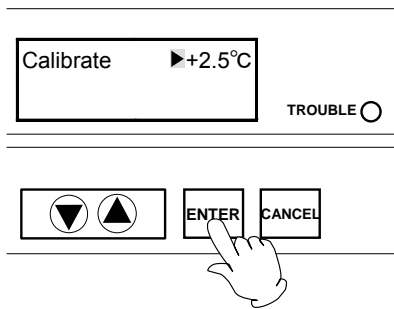

(Ex.)

Indicated temperature on controller: 37°C

Measured temperature: 36°C



Calibration offset: -1

① Press the ENTER key. The setting is decided and the function menu selection screen is displayed.

❖ Offset is adjustable within the range from +3.0°C to -3.0°C.

❖ Temperature correction in overheating prevention device:  
The temperature of overheating prevention device is automatically corrected by the same amount when that of controller is collected.



## Integrating Operation Time

❖ The integrating operation time is a function to check the operation hours of unit. Its content can not be changed.

### 1 Select the item in function menu

- Check that the power is turned on.

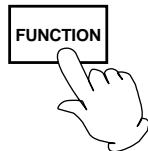

- ① Press the FUNCTION key. The function menu starts and the Sub Display displays the items. Select the item using the FUNCTION key.

### 2 Check integrating operation time

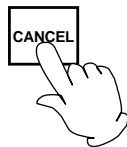
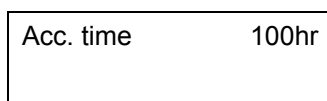

- ① The integrating operation time from factory shipment to now is displayed.
- ❖ The integrating operation time indicates the total sum of lapsed time in standby, operation start wait, operation and operation end state.
- ② Press the CANCEL key to cancel the function menu after checking the time.

## Manual Defrost Operation

### 1 Select the item in function menu

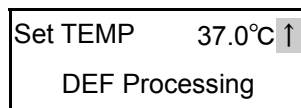

- ① Press the DEFROST key to start the defrost operation.
- The unit ends the defrost operation when the defrost time (parameter) is up. The STANDBY lamp blinks and "DEF Processing" is displayed during the defrost operation.
  - Press the DEFROST key again to suspend defrosting.
  - ❖ Defrost operation is not available in the standby state.
  - ❖ The default value of defrost operation is five minutes.

## Set the Defrost Operation Mode

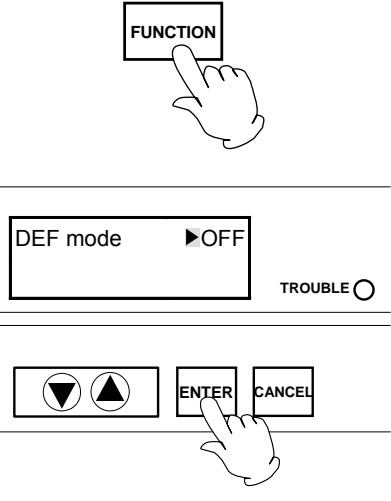
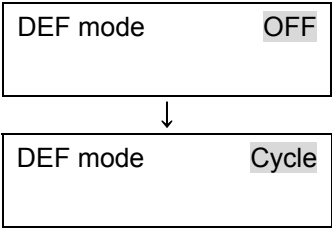
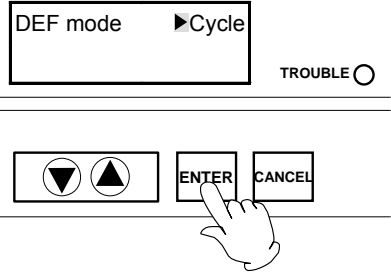
<p><b>1</b></p>	<p><b>Select the item in function menu</b></p> <ul style="list-style-type: none"> <li>• Check that the power is turned on.</li> </ul> 	<ol style="list-style-type: none"> <li>① Press the FUNCTION key. The function menu starts and the Sub Display displays the items. Select the item using the FUNCTION key.</li> <li>② Display the "DEF mode" and press the ENTER key.</li> </ol> <p>❖ Press the CANCEL key to cancel the function menu.</p>
<p><b>2</b></p>	<p><b>Select mode</b></p> 	<ol style="list-style-type: none"> <li>① The "·" (cursor) goes out and the mode currently selected blinks instead. Display the "OFF" or "Cycle" using the "▼▲".</li> </ol>
<p><b>3</b></p>	<p><b>Set defrost operation mode</b></p> 	<ol style="list-style-type: none"> <li>① Press the ENTER key. The defrost operation mode is decided and the function menu selection screen is displayed.</li> </ol>

## Set the Cycle Defrost Operation Time

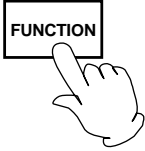
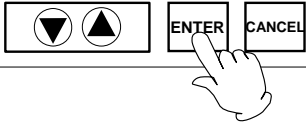
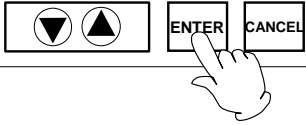
<p><b>1</b></p>	<p><b>Select the item in function menu</b></p> <ul style="list-style-type: none"> <li>• Check that the power is turned on.</li> </ul>  <div style="border: 1px solid black; padding: 5px; margin-top: 10px;">       Cycle   ▶ 5min ON        DEF     23h55m OFF     </div>	<p>① Press the FUNCTION key. The function menu starts and the Sub Display displays the items. Select the item using the FUNCTION key.</p> <p>② Display the "Cycle/DEF" using the FUNCTION key.</p> <ul style="list-style-type: none"> <li>• The Sub Display displays the current setting of cycle defrost operation time for "ON" and "OFF".</li> <li>❖ Press the CANCEL key to cancel the function menu.</li> </ul>
<p><b>2</b></p>	<p><b>Select setting item</b></p> <div style="border: 1px solid black; padding: 5px; margin-bottom: 10px;">       Cycle   ▶ 5min ON        DEF     23h55m OFF   TROUBLE ○     </div> 	<p>① Select the setting item using the FUNCTION key and press the ENTER key.</p> <div style="border: 1px solid black; padding: 5px; margin-top: 10px;">       Cycle   ▶ 5min ON        DEF     23h55m OFF     </div> <p style="text-align: center;">↓</p> <div style="border: 1px solid black; padding: 5px; margin-top: 10px;">       Cycle         5min ON        DEF   ▶ 23h55m OFF     </div>
<p><b>3</b></p>	<p><b>Input value</b></p>	<p>① The "·" (cursor) goes out and the current value blinks instead. Edit the value using the "▼▲".</p> <div style="border: 1px solid black; padding: 5px; margin-top: 10px;">       Cycle         5min ON        DEF     23h55m OFF     </div> <p style="text-align: center;">↓</p> <div style="border: 1px solid black; padding: 5px; margin-top: 10px;">       Cycle         10min ON        DEF     23h55m OFF     </div>
<p><b>4</b></p>	<p><b>Set cycle defrost operation time</b></p> <div style="border: 1px solid black; padding: 5px; margin-bottom: 10px;">       Cycle   ▶ 10min ON        DEF     23h55m OFF   TROUBLE ○     </div> 	<p>① Press the ENTER key. The cycle defrost operation time is decided and the function menu selection screen is displayed.</p>

## Set the Refrigerator Operation Mode

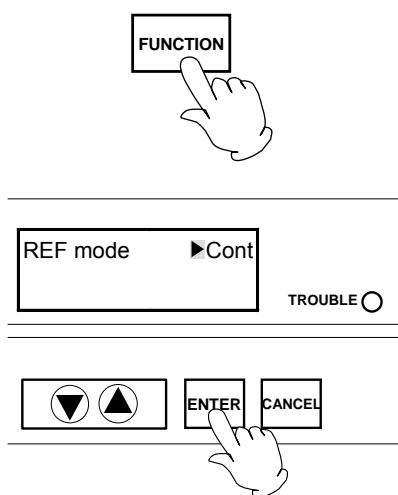
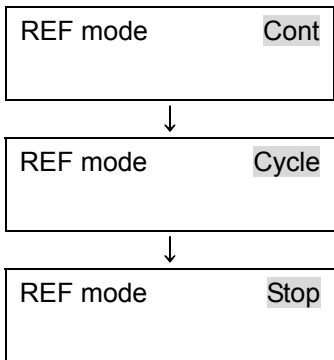
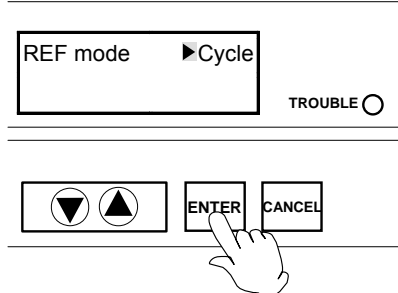
<p><b>1</b></p>	<p><b>Select the item in function menu</b></p> <ul style="list-style-type: none"> <li>• Check that the power is turned on.</li> </ul>  <p>① Press the FUNCTION key. The function menu starts and the Sub Display displays the items. Select the item using the FUNCTION key.</p> <p>② Display the "REF mode" and press the ENTER key.</p> <ul style="list-style-type: none"> <li>❖ Press the CANCEL key to cancel the function menu.</li> </ul>
<p><b>2</b></p>	<p><b>Select mode</b></p>  <p>① The " " (cursor) goes out and the mode currently selected blinks instead. Display the "Cont", "Cycle" or "Stop" using the "▼▲".</p>
<p><b>3</b></p>	<p><b>Set refrigerator operation mode</b></p>  <p>① Press the ENTER key. The refrigerator operation mode is decided and the function menu selection screen is displayed.</p> <ul style="list-style-type: none"> <li>❖ The refrigerator continues to operate if the setting temperature is set to 44.0 °C or below in the continuous operation.</li> <li>❖ It repeats 12-minute operation and 12-minute halt condition in the cycle operation.</li> </ul>

## Set the Communication Lockout Mode (Optional accessory)

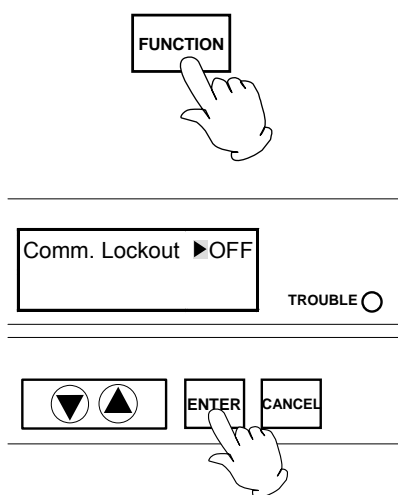
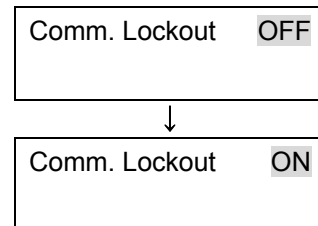
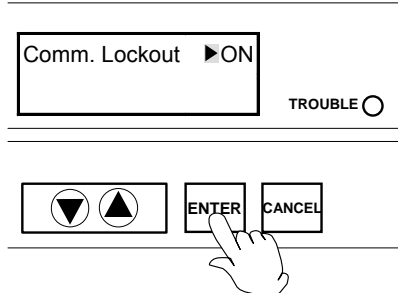
<p><b>1</b></p>	<p><b>Select the item in function menu</b></p> <ul style="list-style-type: none"> <li>• Check that the power is turned on.</li> </ul>  <p>① Press the FUNCTION key. The function menu starts and the Sub Display displays the items. Select the item using the FUNCTION key.</p> <p>② Display the "Comm. Lockout" and press the ENTER key.</p>
<p><b>2</b></p>	<p><b>Select mode</b></p>  <p>① The "·" (cursor) goes out and the mode currently selected blinks instead. Display the "ON" or "OFF" using the "▼▲".</p>
<p><b>3</b></p>	<p><b>Set communication lockout mode</b></p>  <p>① Press the ENTER key. The communication lockout mode is decided and the function menu selection screen is displayed.</p>

## The Independent Overheating Prevention Device

### 1 Select the item in function menu

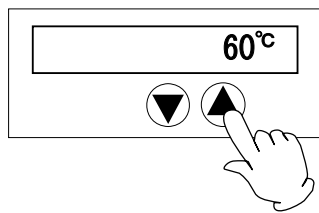

① Set the temperature using the "▼▲".

### Notes for the independent overheating prevention device



- In case there is a small difference between the set values of temperature for the independent overheating prevention device and that of controller, the independent overheating prevention device may be activated and stops the operation. Set the temperature of the device so it be at least 10°C or more higher than that of controller.
- The default value of the independent overheating prevention device at factory shipment is 60°C. The setting temperature range is 0 to 65°C.
- The independent overheating prevention device is not intended to protect the sample from overheating.
- For the independent overheating prevention device to start at the required temperature, first establish a stable operation at such a required temperature, and lower gradually the setting value of the independent overheating prevention device, and then check if the operation is maintained with stable at the required temperature. (It takes about five seconds for the device to activate. Check after waiting for five seconds.) When the device activates, the unit indicates Er07 and stops the operation.
- Wait for about five seconds for the period to record it before turning off the power after the setting temperature of independent overheating prevention device is changed.

## **WARNING!**

### **If a problem occurs**

-  If smoke or strange odor should come out of this unit for some reason, turn off the power key right away, and then turn off the circuit breaker and the main power. Immediately contact a service technician for inspection. If this procedure is not followed, fire or electrical shock may result. Never perform repair work yourself, since it is dangerous and not recommended.

### **Substances that cannot be used**

-  Never use explosive substances, flammable substances and substances that include explosive or flammable ingredients in this unit. Explosion or fire may occur. (Refer to page 62 "List of Dangerous Substances".)

## **CAUTION!**

### **Do not step on this unit**

-  Do not step on this unit. It will cause injury if this unit fall down or break.

### **Do not put anything on this unit**

-  Keep clear on the unit to prevent dropping and injury. Do not put flammable such as paper around it.

### **During a thunder storm**

-  During a thunderstorm, turn off the power key immediately, then turn off the circuit breaker and the main power. If this procedure is not followed, fire or electrical shock may be caused.

### **About the amount of samples**

-  If the excessive amount of sample is set, it could be impossible to control the temperature normally. To keep the temperature control accuracy, do not use this unit in overload.

### **Recovering after power failure**

-  When power is supplied after a power failure, the device automatically starts operation again with the same state as just before the power failure.

When I used a backup power supply for blackout return, but a blackout occurred for need in less than 30 minutes more than 30 minutes as for the charge time of the backup power supply since I turned on electricity in a device, there is the thing that a blackout does not return temporarily. The blackout return function operates normally after it was charged a backup power supply enough because I am not abnormal.

## Daily Inspection and Maintenance

### **WARNING!**

- Disconnect the power cable from the power source when doing an inspection or maintenance unless needed.
- Perform the daily inspection and maintenance after returning the temperature of this unit to the normal one.
- Do not disassemble this unit.

### **CAUTION!**

- Use a well-drained soft cloth to wipe dirt on this unit. Do not use benzene, thinner or cleanser for wiping. Do not scrub this unit. Deformation, deterioration or color change may result in.

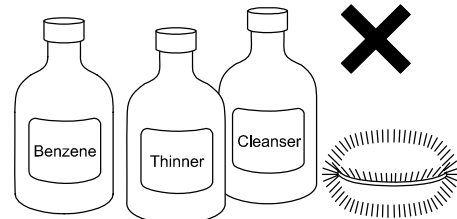

## Monthly maintenance

- Check the earth leakage breaker function.
  1. Connect the power cord.
  2. Turn the breaker on.
  3. Push the red test switch by a ballpoint pen etc.
  4. If there is no problem, the earth leakage breaker will be turned off.

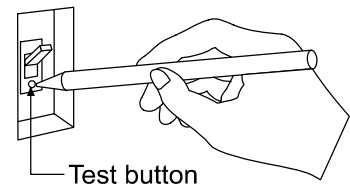

- Check the movement of the independent overheating prevention device.

Perform the fixed temperature operation of device with certain preset temperature. Then set the operation temperature of independent overheating prevention device to the value approximately 5°C lower than the preset temperature of device.

In normal condition, the device shuts off the heating circuit in a few seconds, at the same time the TROUBLE lamp lights on and the "Er07" is indicated accompanied with a warning buzzer.

- Clean the fin on condenser.

Remove the grill on the left face of the IN604, or left side in front of the IN804, then remove the dust on the surface of fin on condenser with a vacuum cleaner.

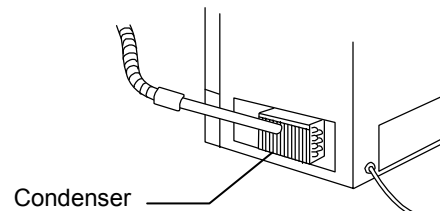

### **CAUTION!**

Do not soak the fin for cleaning.

- ❖ Make sure to check the movement of earth leakage breaker above and overheating prevention device before long term operation or night-time unmanned operation.

For any questions, contact the dealer who you purchased this unit from, or the nearest sales division in our company.



### When not using this unit for long term / When disposing

#### **CAUTION!**

##### When not using this unit for long term...

- Turn off the power and disconnect the power cord.

#### **WARNING!**

##### When disposing...

- Keep out of reach of children.
- Remove the door and driving parts.
- Treat as large trash.

#### ***Environmental protection should be considered***

We request you to disassemble this unit as possible and recycle the reusable parts considering to the environmental protection. The feature components of this unit and materials used are listed below.

Component Name	Material
<b>Main Parts</b>	
Outer covering	Chrome-free electro galvanized chemical proof bake finished steel plate
Furnace	Stainless steel
Heat insulation material	Expanded polystyrene
Plates	PET resin film
<b>Electrical Parts</b>	
Switches, Relay	Resin, Copper and other
Control panel	ABS resin
Circuit boards	Glass fiber and other
Heater	Iron-chrome wire
Power cord	Synthetic rubber coating, Copper, Nickel and other
Wiring material	Glass fiber, Incombustible vinyl, Copper, Nickel and other
Seals	Resin
Sensor	Stainless steel SUS304 and other

## Error Indication

---

<b>Error code</b>	<b>Name</b>	<b>Cause</b>	<b>Solution</b>
<b>Er.01</b>	Sensor error	Temperature sensor failure	Contact to our service division.
<b>Er.02</b>	SSR error	SSR failure	Contact to our service division.
<b>Er.03</b>	Heater error	Heater disconnection (Detection is available only during the heater is controlled.)	Contact to our service division.
<b>Er.07</b>	Independent overheating prevention device activation	Independent overheating prevention device is in operation	Reset the power supply, and then adjust the setting temperature of the independent overheating prevention device.
<b>Er.10</b>	Main relay error		Contact to our service division.
<b>Er.13</b>	Refrigerator error	Overload of refrigerator	Contact to our service division.
<b>Er.14</b>	RAM error	Checksum abnormality in RAM	Contact to our service division.
<b>Er.15</b>	EEPROM error	Checksum abnormality in EEPROM	Contact to our service division.

## Trouble Shooting

Problem	Possible Cause	Solution
The device does not start when turning on the power switch.	Earth leakage breaker failure	Replace the part.
	Power switch failure	Replace the part.
	Power source failure	Connect to the appropriate power source
Temperature does not rise.	Heater disconnection	Replace the part.
	SSR failure	Replace the part.
	Temperature controller failure	Replace the part.
Temperature does not fall.	Temperature sensor failure	Replace the part.
	Temperature controller failure	Replace the part.
	Clogging of condenser with dust	Clean the fin on condenser
	Much frost on evaporator	Defrost
	Relay failure	Replace the part.
	Power source failure	Connect to the appropriate power source
	Refrigerator failure	Repair or replace the part.
Heater does not stop working when the temperature reaches setting value.	SSR failure	Replace the part.
	Temperature controller failure	Replace the part.

### If power failure occurs...

The unit returns automatically to start operation automatically with the same condition as just before the failure when it occurs during operation and is recovered. But the units don't return automatically to the operation when the power failure manual return function is set even though the power feeding is recovered.

When I used a backup power supply for blackout return, but a blackout occurred for need in less than 30 minutes more than 30 minutes as for the charge time of the backup power supply since I turned on electricity in a device, there is the thing that a blackout does not return temporarily. The blackout return function operates normally after it was charged a backup power supply enough because I am not abnormal.

### In Case of Request for Repair

If the failure occurs, stop the operation, turn OFF the power switch, and unplug the power plug. Please contact the sales agency that this unit was purchased, or the Yamato Scientific's sales office.

#### < Check following items before contact >

- ◆ Model Name of Product
  - ◆ Production Number
  - ◆ Purchase Date
  - ◆ About Trouble (in detail as possible)
- } See the production plate attached to this unit.

### Minimum Retention Period of Performance Parts for Repair

The minimum retention period of performance parts for repair of this unit is 7 years after discontinuance of this unit.

The "performance part for repair" is the part that is required to maintain this unit.

# Specification

	IN604	IN804
Method	Forced circulation	
Temperature control range ※1	- 5°C to +50°C	
Temperature adjustment accuracy ※1	±0.3°C (Refrigerator is in continuous operation) ±1.0°C (Refrigerator is in cycle operation)	
Temperature distribution accuracy ※1	±1.0°C (at 37°C, Refrigerator is in continuous operation)	
Time required to reach highest temperature ※1	20°C to 50°C: 30min.	20°C to 50°C: 55min.
Time required to reach lowest temperature ※1	20°C to -10°C: 55min.	20°C to -10°C: 90min.
Temperature control system	PID control by micro computer, programmable with 32 steps	
Temperature setting system	Digital setting by up/down keys	
Temperature display system	Digital display by orange LED	
Timer display range	0min to 99h59min, 100 to 999.5h	
Timer resolution	1 minute or 1 hour	
Operation mode	Fixed temperature operation, Auto start operation, Auto stop operation, Program operation (max. of 32 steps, repeat operation)	
Additional functions	Timer, Clock, Total operating hours counter (max. of 49999h), Calibration offset	
Refrigerator	Air-cooled and full-closed type <b>reciprocating</b> compressor, 250W	Air-cooled and full-closed type <b>reciprocating</b> compressor, 300W
Cooling medium	<b>R134a 310±5g</b>	<b>R404A 260±5g</b>
Heater	Iron-chrome heater 550W	Iron-chrome heater 750W
Heater circuit	Triac zero-cross method	
Fan of blower	Axial fan	
Sensor	Platinum resistance bulb	
Interior	<b>Stainless steel</b>	
Exterior	<b>Chrome-free electro galvanized chemical proof bake finished steel plate</b>	
Heat insulation material	Expanded polystyrene (non- fluorocarbon)	
Inner door	Tempered glass 5mm thick	Tempered glass 5mm thick (divided into upper and lower)
Safety device	Earth leakage breaker, Independent overheating prevention device, Alarm buzzer, Key lock function, Self-diagnostic functions (Sensor error, Heater disconnection, Triac short circuit, Main relay error, Automatic overheating prevention)	
Defrost function	Manually ON/automatic OFF, Cycle operation	
Cable port	Inner diameter: 30mm (right surface of the unit)	
Internal dimensions (W×D×H mm) ※3	600×477×500	600×477×1000
External dimensions (W×D×H mm) ※3	710×645× <b>913</b>	710×645×1630

	IN604	IN804
Capacity	143L	286L
Withstand load of shelf	15kg/one shelf	
Number of shelf bracket step	13	23
Interval of shelf bracket steps	30mm	
Power supply (50/60Hz)	100V AC, 13A (Breaker capacity 15A)	100V AC, 14A (Breaker capacity 15A)
Weight	Approx. 93Kg	Approx. 120Kg
Accessories	Shelf (stainless punching metal) × 3	Shelf (stainless punching metal) × 5
	Shelf bracket × 6	Shelf bracket × 10
	Instruction manual	
Optional accessory	External communication function (RS485), External communication adapter (RS-232C conversion), Temperature output terminal, Alarm output terminal, Time up signal output terminal, Hybrid recorder, Extra shelf set, Stand for IN604	

- ※1 Performance data has been measured at room temperature of 23°C ± 5°C, humidity of 65% RH ± 5%, and no-load with the power supply of AC100V.
- ※2 Operating environmental temperature range for this device is 5°C ~ 35°C.
- ※3 Do not include protrusions.

## IN604

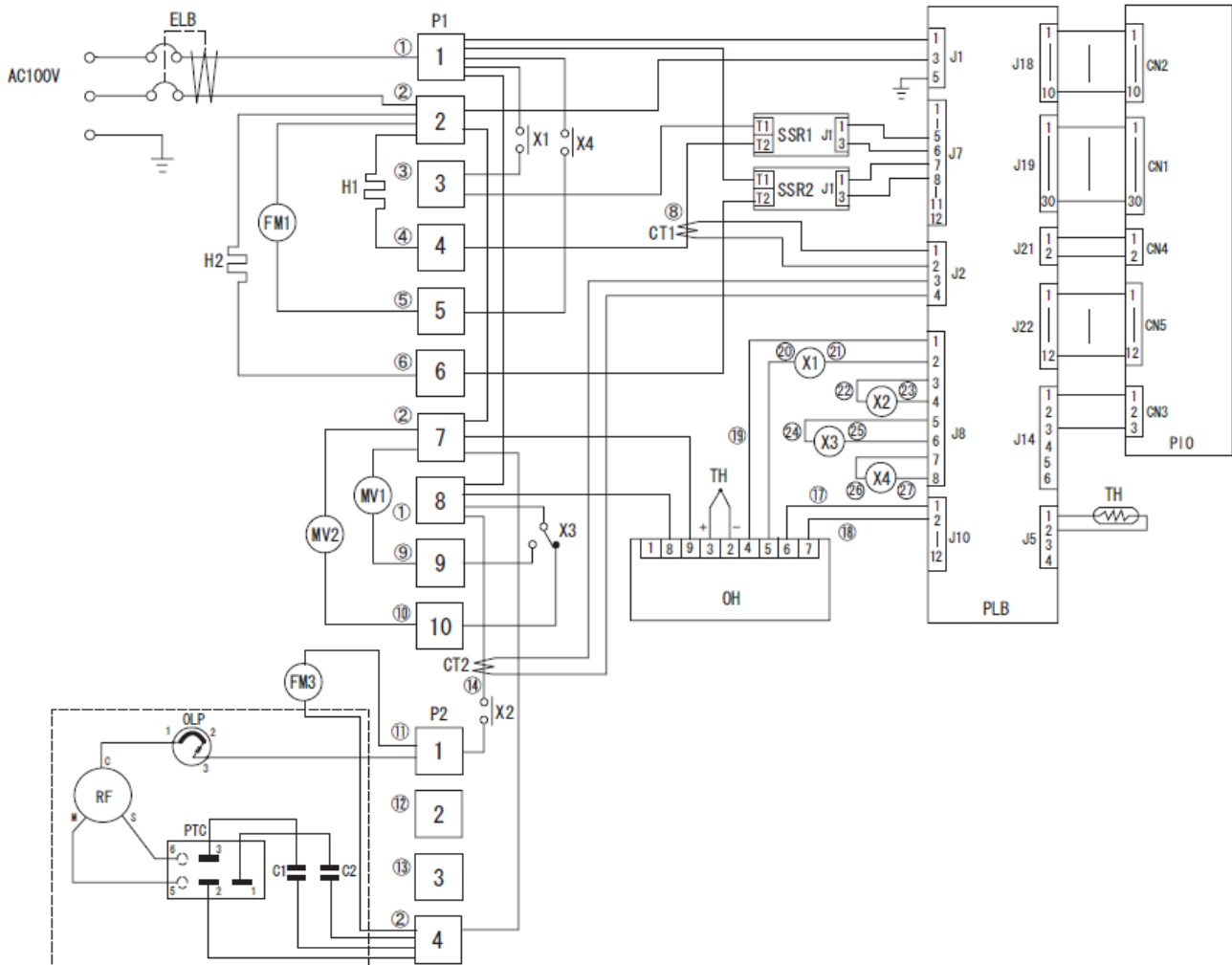

Symbol	Part name	Symbol	Part name
ELB	Earth leakage breaker	TH	Temperature sensor
P1, 2	Terminal block	OH	Independent overheating prevention device
H1	Heater (internal)	SSR1, 2	Solid-state relay
H2	Heater (door)	PLB	PLANAR board
FM1	Fan motor (internal)	PIO	Display circuit board
FM3	Fan motor (refrigerator)	CT1, 2	Current transformer
MV1	Solenoid valve (defrost)	OLR	Overload relay
MV1	Solenoid valve (returning tube)	C1	Operation condenser
X1	Relay (internal heater)	C2	Starting condenser
X2	Relay (refrigerator)	PTC-ASM	PTC Starter
X3	Relay (solenoid valve)	RF	Refrigerator
X4	Relay (fan)		

## IN804

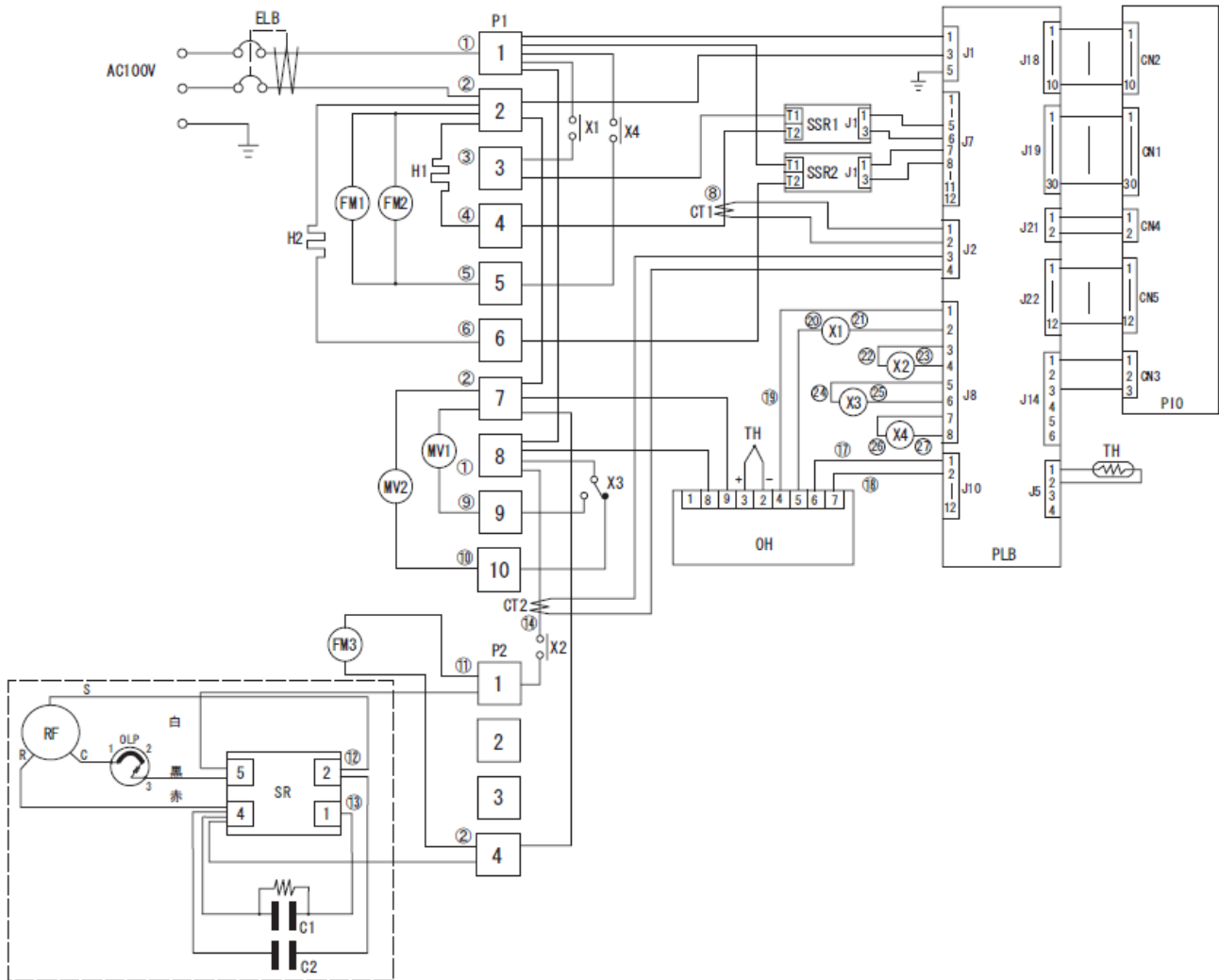

Symbol	Part name	Symbol	Part name
ELB	Earth leakage breaker	TH	Temperature sensor
P1, 2	Terminal block	OH	Independent overheating prevention device
H1	Heater (internal)	SSR1, 2	Solid-state relay
H2	Heater (door)	PLB	PLANAR board
FM1, 2	Fan motor (internal)	PIO	Display circuit board
FM3	Fan motor (refrigerator)	CT1, 2	Current transformer
MV1	Solenoid valve (defrost)	OLR	Overload relay
MV2	Solenoid valve (returning tube)	C1	Operation condenser
X1	Relay (internal heater)	C2	Starting condenser
X2	Relay (refrigerator)	PTC-ASM	PTC Starter
X3	Relay (solenoid valve)	RF	Refrigerator
X4	Relay (fan)		



# Replacement Parts Table

## Common parts

Part Name	Code No.	Specification	Manufacturer
Control board (CR3R)	LT00013637	Hitec IV CR3R	Yamato Scientific
Display circuit board	LT00027240	PIO12	Yamato Scientific
Relay	2-05-000-0013	JA1aF-TM-DC6V	Panasonic
Relay	2-05-000-0026	G3R-1-T DC6V	OMRON
Terminal block	<a href="#">LT00031665</a>	<a href="#">TFD250-ABC-10P</a>	<a href="#">TERMINAL</a>
Terminal block	<a href="#">LT00031661</a>	<a href="#">TFD250ABC-4P</a>	<a href="#">TERMINAL</a>
Fan	2-15-000-0010	UF12A10BTH	Yamato Scientific
SSR	LT00028423	SSR-01	Yamato Scientific
Temperature sensor	1-16-003-0052	Pt100Ω K thermocouple	Yamato Scientific
Earth leakage breaker	<a href="#">LT00029774</a>	<a href="#">NV-L22GR 15A</a>	<a href="#">MITSUBISHIELECTRIC</a>
Independent overheating prevention device	2-10-011-0002	PAS3K1-0Y0BOY	Yamato Scientific
Solenoid valve	3-02-006-0003	SEV-502DXF	Saginomiya
Solenoid valve	3-02-006-0004	NEV-603DXF	Saginomiya
Compressor	3-01-006-0003	C-2SN250LOU	SANYO
Condenser	3-01-006-0007	1-000-0005-07-0	SANYO
Fan motor	3-01-006-0006	SE4-CO41NP	SANYO
Dryer	30-20-003-6002	KC-10432	Meiko Kiki
Charge valve	3-25-001-0002	FV222D0010C	Meiko Kiki
Accumulator	3-23-000-0001	SAC-154000	SANYO

## IN604

Part Name	Code No.	Specification	Manufacturer
Heater	IN61S-40231	550W/100V	Yamato Scientific
Cord heater	IN600-40080	19W/100V	Yamato Scientific
Evaporator	IN600-30311		Yamato Scientific
Capillary	<a href="#">IN604-30470</a>	φ 1.0 × 3000mm	Yamato Scientific
Compressor	<a href="#">LT00035567</a>	<a href="#">FGS125HAS</a>	<a href="#">Embraco</a>

## IN804

Part Name	Code No.	Specification	Manufacturer
Heater	IN81S-40590	750W/100V	Yamato Scientific
Cord heater	IN81S-40480	54W/100V	Yamato Scientific
Evaporator	IN800-30351		Yamato Scientific
Capillary	IN801-40091	φ 1.0 × 2300mm	Yamato Scientific
Capillary (pressure adjusting)	IN802-40160	φ 1.6 × φ 2.6 × 400mm	Yamato Scientific
Caster	4-29-001-0016	413S-N65	Hammer
Caster (with stopper)	4-29-001-0004	420S-N65	Hammer
Compressor	<a href="#">LT00035568</a>	<a href="#">NEK2134GK</a>	<a href="#">Embraco</a>

## List of Dangerous Substances



Never use explosive substances, flammable substances and substances that include explosive or flammable ingredients in this unit.

### EXPLOSIVE

<b>EXPLOSIVE:</b>	Ethylene glycol dinitrate (nitro glycol), Glycerin trinitrate (nitroglycerine), Cellulose nitrate (nitrocellulose), and other explosive nitrate esters
	Trinitrobenzene, Trinitrotoluene, Trinitrophenol (picric acid), and other explosive nitro compounds
	Acetyl hidroperoxide (peracetic acid), Methyl ethyl ketone peroxide, Benzyl peroxide, and other organic peroxides

### FLAMMABLE

<b>IGNITING:</b>	Lithium (metal), Potassium (metal), Sodium (metal), Yellow phosphorus, Phosphorus sulfide, Red phosphorus, Celluloid compounds, Calcium carbide, Lime phosphate, Magnesium (powder), Aluminum (powder), Powder of metals other than magnesium and aluminum, Sodium hydrosulfite
<b>OXIDIZING:</b>	Potassium chlorate, Sodium chlorate, Ammonium chlorate, and other chlorate
	Potassium perchlorate, Sodium perchlorate, Ammonium perchlorate, and other perchlorate
	Potassium peroxide, Sodium peroxide, Barium peroxide, and other inorganic peroxide
	Potassium nitrate, Sodium nitrate, Ammonium nitrate, and other nitrate
	Sodium chlorite and other chlorites
Calcium hypochlorite and other hypochlorites	
<b>INFLAMMABLE LIQUID:</b>	Ethyl ether, Gasoline, Acetaldehyde, Propylene chloride, Carbon disulfide, and other flammable substances having a flash point of lower than -30°C
	Normal hexane, ethylene oxide, acetone, benzene, methyl ethyl ketone, and other flammable substances having a flash point of -30°C or higher but lower than 0°C
	Methanol, Ethanol, Xylene, Pentyl acetate (amyl acetate), and other flammable substances having a flash point of 0°C or higher but lower than 30°C
	Kerosene, Light oil (gas oil), Oil of turpentine, Isopentyl alcohol (isoamyl alcohol), Acetic acid, and other flammable substances having a flash point of 30°C or higher but lower than 65°C
<b>FLAMMABLE GAS:</b>	Hydrogen, Acetylene, Ethylene, Methane, Propane, Butane, and other flammable substances which assume a gaseous state at 15°C and 1 atm

(Source: Appendix Table 1 of Article 6 of the Industrial Safety and Health Order in Japan)



## Responsibility

Please follow the instructions in this document when using this unit. Yamato Scientific has no responsibility for the accidents or breakdown of device if it is used with a failure to comply. Never conduct what this document forbids. Unexpected accidents or breakdown may result in.

## Note

- ◆ The contents of this document may be changed in future without notice.
- ◆ Any books with missing pages or disorderly binding may be replaced.

Instruction Manual for  
**Programmable Low Temperature Incubator**  
**Model IN604/804**

First Edition June. 5, 2012  
Revised JUN, 12, 2012

---

**Yamato Scientific Co., Ltd.**

2-1-6 Nihonbashi Honcho, Chuo-ku,  
Tokyo, 103-8432, Japan

<http://www.yamato-net.co.jp>