



# **Heating Block**

**Type HF100/200**

First Edition

**Yamato Scientific Co., Ltd.**



1. Name and Function of Components .....	1
Main body .....	1
Operation panel .....	2
Description of characters displayed in the temperature controller .....	3
2. Operation Method .....	4
Preparation .....	4
List of operation modes and functions .....	5
Fixed-value operation (continuous operation) mode .....	6
Quick auto-stop operation .....	8
Auto-stop operation .....	11
Auto-start operation .....	15
Other functions .....	19
3. In Case of Trouble .....	23
Error display .....	23
Troubleshooting guide .....	23
4. Specifications .....	24
5. Wiring Diagram .....	25



# 1.Name and Function of Components

## Main body

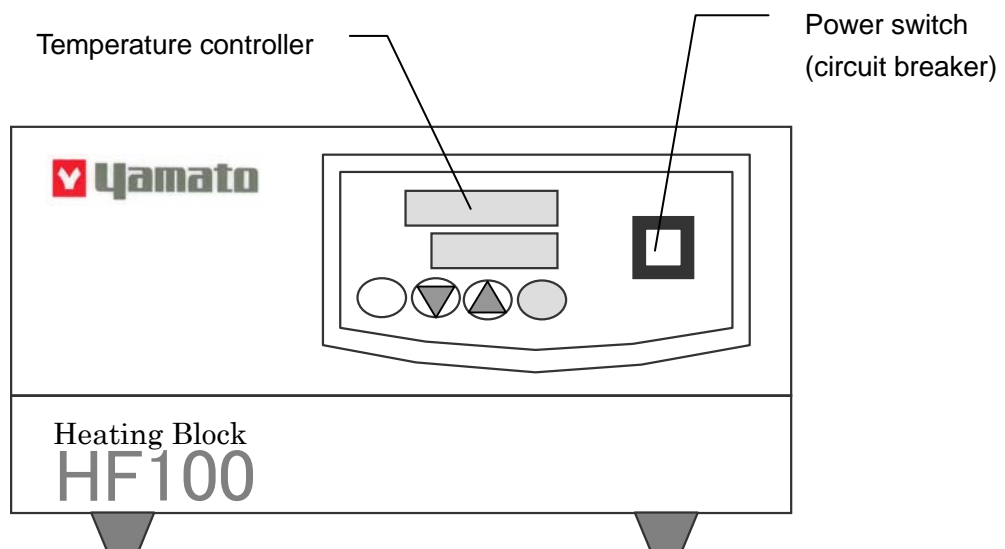
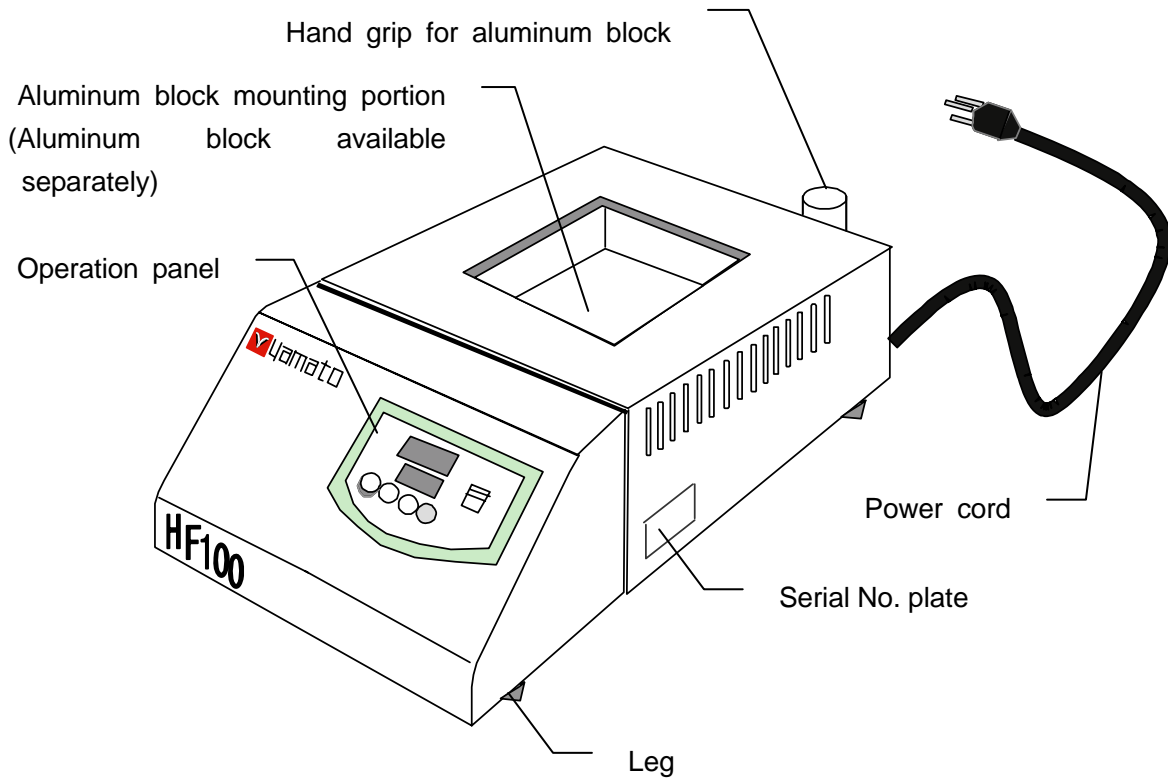

# 1. Name and Function of Components

## Operation panel

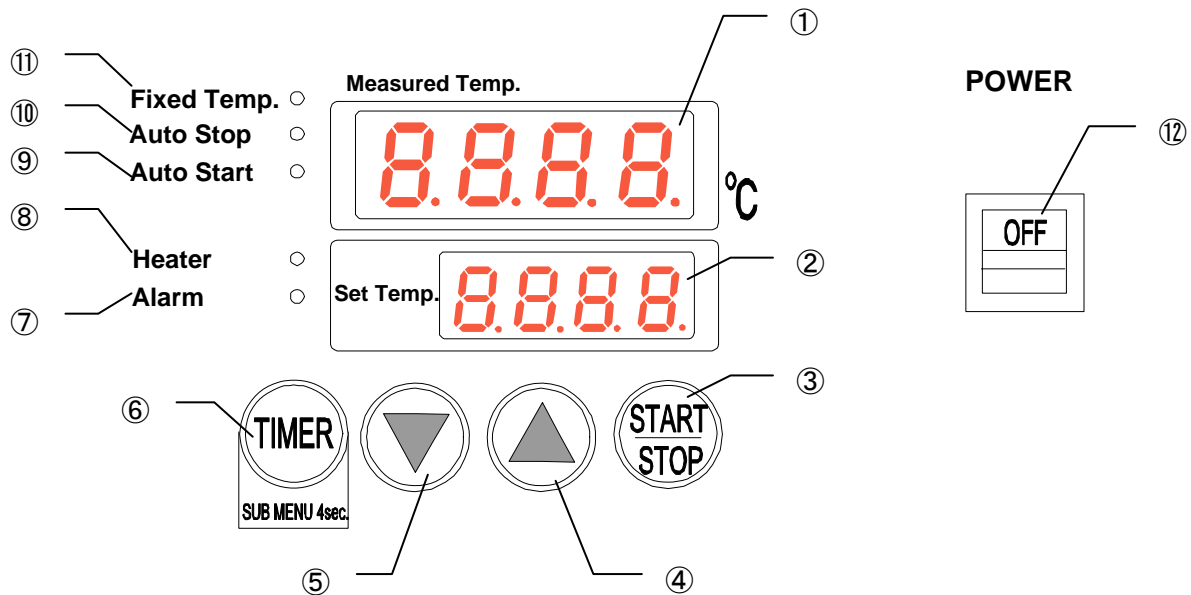

No.	Name	Function
①	Measured temperature display	Displays the bath measured temperature, set mode character, alarm temperature.
②	Set temperature display	Displays the set temperature, timer set time, remaining timer-operation time, character to set the sub-menu.
③	Start/stop key	Used to start/stop operation. Keep pressing for one second.
④	▲ key	Used to increment the set value.
⑤	▼ key	Used to decrement the set value.
⑥	Timer key	Used to set the timer and sub-menu.
	Sub-menu selector key	Keep pressing the key for four seconds, and such functions as key lock, calibration offset temperature setting, and power failure compensation selection can be set.
⑦	Alarm lamp	Flashes in case of alarm
⑧	Heater lamp	ON when the heater output is ON
⑨	Fixed-value operation lamp	ON during the fixed-value operation
⑩	Auto start operation lamp	ON during auto-start operation with the <b>TIMER</b> key
⑪	Auto stop operation lamp	ON during auto-stop operation with the <b>TIMER</b> key
⑫	Power switch	ON to turn ON system power supply and OFF to turn OFF system power supply. Circuit breaker to turn OFF power supply at over-current

# 1. Names and functions of parts

## Description of characters displayed in the temperature controller

The controller uses a display of 7-segment LED. Characters to display operation functions are indicated in the "Measured Temp." screen.

Character displays and corresponding meanings are described below.

Auto-stop or Auto-start operation can be selected with the <b>TIMER</b> key.			
Character	Identifier	Name	Meaning
ASTP	AStP	Timer menu mode Timer setting mode display	Means that the auto-stop operation has been selected.
End	End	Time-up	Means that the auto-stop operation has ended.
AStr	AStr	Timer menu mode Timer setting mode display	Means that the auto-start operation has been selected.
Function settings as follows can be made from the sub-menu. Keep pressing the <b>TIMER</b> key for four seconds, and the mode changes to the sub-menu mode. To return to the original screen, keep pressing the <b>TIMER</b> key.			
Lock	Lock	Sub-menu mode Locked at fixed value	Function to lock so as to prevent changing of the set contents
cAL	cAL	Sub-menu mode Calibration offset	Temperature compensation function to allow the aluminum block temperature to agree with the control temperature (see page 23)
Pon	Pon	Sub-menu mode Power failure compensation selection	Function to select whether the recovery from power failure is to be made automatically or manually.
on	on	Sub-menu mode Locking the setting Power failure compensation selection auto reset	Select ON with the ▲ key to activate lock to prevent change of the setting and when the recovery from power failure is to be made automatically.
off	off	Sub-menu mode Canceling locking of the setting Power failure compensation selection manual reset	Select OFF with the ▼ key to cancel locking to enable free change of the setting and when the recovery from power failure is to be made manually.
Two characters to indicate that operation is not possible			
nG	nG	Operation impossible	Selection of the mode that is inoperable during operation causes display of nG in the set temperature display, rejecting any attempt of change.
Loc	Loc	Sub-menu mode Locking the set contents	Attempt to change the mode while the Lock function is ON causes display of Loc in the set temperature display, rejecting any attempt of change.

# 2.Operation Method

## Preparation

### From mounting of the aluminum block to operation start

#### 1. Mounting the aluminum block

Use the dedicated aluminum block available separately.  
The use of an attached dedicated hand grip will prove convenient for mounting/removal of the aluminum block.

Caution :  
 • Possible hazard of burn. Use the hand grip when the aluminum block is sufficiently cooled.  
 • Do not raise the temperature while keeping the hand grip left attached.

※ If necessary, a bar thermometer may be inserted into a thermometer hole (used also for attaching the hand grip) of the aluminum block.  
(Use the thermometer of maximum 200°C or more. Since the bar thermometer is not attached, obtain it separately.)

Hand grip for aluminum block

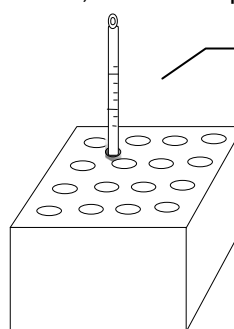
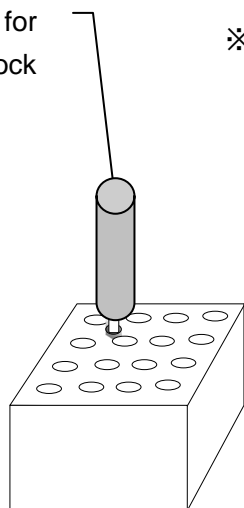

Bar thermometer

#### 2. Connecting the power cord

Connect the power cord to an appropriate receptacle firmly.  
The receptacle to be connected must be of a 100V 15A type.

#### 3. Installing the sample

To maintain the temperature accuracy, use a sample container appropriate in size to the sample installation hole of the aluminum block.

#### 4. Turning ON power supply

Turn ON the **POWER** switch of the main body and set the desired temperature using **▲▼** keys of the operation panel.

#### 5. Starting operation

Press the **START/STOP** key of the operation panel for one second, and the operation begins.

### Aluminum block, which is available separately

The following types of aluminum blocks are available for HF100/HF200. Be sure to use the aluminum block dedicated to the product concerned.

Specify the product code No. when purchasing.

Product code No.	Name/size	No. of blocks that can be set	
213173	For 0.5m micro tube	48	Can be used commonly for HF21/41/61
213174	For 1.5m micro tube	36	
213181	For 12 mm test tube	36	
213182	For 15 mm test tube	25	
213183	For 16.5 mm test tube	25	
213184	For 18 mm test tube	20	
213175	For 21 mm test tube	12	
213176	For 24 mm test tube	12	
213185	For 25 mm test tube	12	
213177	For 30 mm test tube	8	



## 2. How to operate the unit

### List of operation modes and functions

The operation functions of the product are as follows.

No.	Nomenclature	Description	Page
1	Fixed-value operation	Continuous operation mode Press the <b>START/STOP</b> key for one second after temperature setting, and the continuous operation begins. Pressing the <b>START/STOP</b> key again for one second causes stop of operation.	P.6
2	Quick auto-stop operation	Causes activation of the timer halfway of fixed-value operation, then automatic operation stop after the set period. This function is used "to set the automatic stop after the set time", "to set, in the course of operation, the automatic stop in several hours."	P.8
3	Auto-stop operation	Used "to set the automatic stop at the specified time" before starting the operation. In the auto-stop mode, the timer starts counting when the set temperature is reached.	P.11
4	Auto-start operation	Used to start the automatic operation in several hours, that is, "to set the automatic start at the specified time."	P.15

※ The temperature and timer's set time can be changed during operation.

※ Cautions for the auto-stop operation

- The timer does not start counting till the bath temperature reaches the set level.
- When the set temperature is below the bath temperature, the timer does not start counting till the bath temperature drops below the set temperature.

The operation functions of sub-menu of the product are as follows.

Keep pressing the **TIMER** key for four seconds. The mode changes to the sub-menu mode.

1	Calibration offset function	The calibration offset function is to compensate for any difference occurring between the target bath temperature and controller control temperature (sensor temperature). Compensation can be made either to the positive or negative side over the entire temperature range of the system.	P.21
2	Power failure compensation selection function	This is a function to select automatic or manual return to the operation state after power failure. Automatic return with <b>Pon</b> ON and manual return with <b>Pon</b> OFF	

The operation function of this device is as follows.

No.	Nomenclature	Description	Page
1	Over-temperature preventive function	The automatic over-temperature preventive function is incorporated. When the bath temperature rises excessively along with the set temperature of the device, this is set to activate automatically at +12°C. Stop operation when this function is activated. The Alarm lamp flashes. To cancel, turn ON the power switch newly again (manual reset).	P.19

# 2 How to operate the unit

## Fixed-value operation (continuous operation) mode

### For fixed-value operation

In this mode, the operation is started (by pressing the **START/STOP** key for one second) and continued at the set temperature till power supply is turned OFF (by pressing the **START/STOP** key for one second).

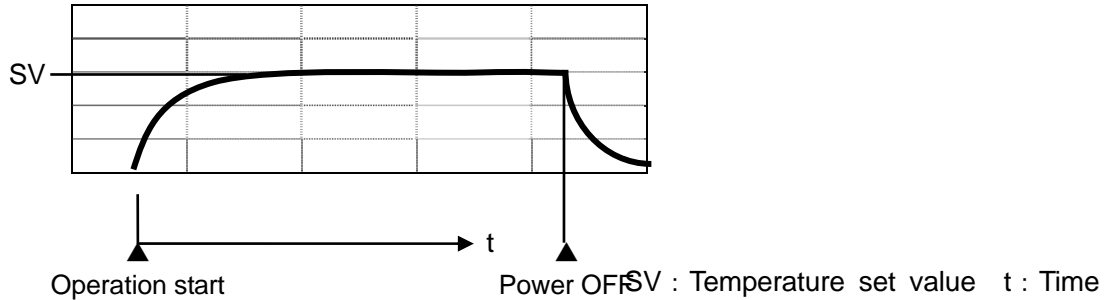

### 1. Turn ON the **POWER** switch to start power supply.

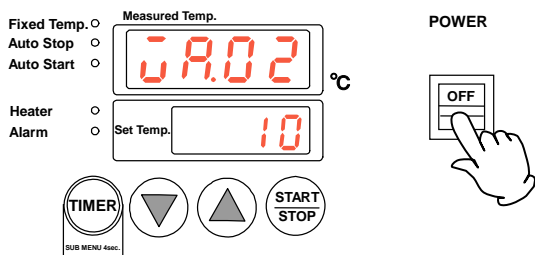

The initial screen is shown for four seconds.

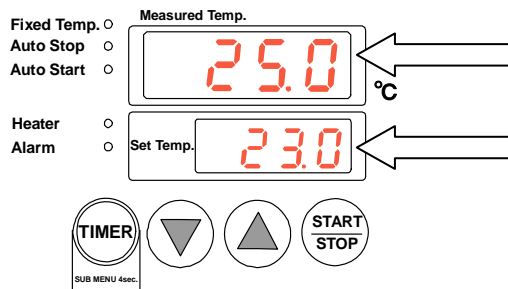

The temperature setting screen appears after the initial screen has been shown for four seconds.

Shows the current bath temperature.

Shows the current set temperature.

### 2. Set the temperature.

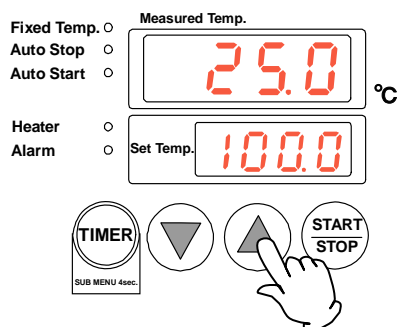

Set the desired temperature with **▼** and **▲** keys.

The set temperature rises with the **▲** key and lowers with the **▼** key.

**⚠ Set the temperature over a range from the room temperature + 5.0°C up to 200.0°C.**

# 2. How to operate the unit

## Fixed-value operation (continuous operation) mode

### 3. Start operation.

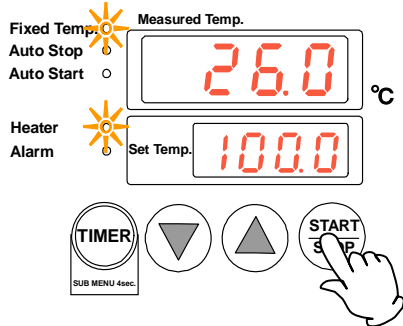

Keep pressing the **START/STOP** key.

Fixed Temp. and Heater lamps go ON and the operation begins.

When the bath temperature reaches the set temperature, the Heater lamp flashes. Now the bath temperature is under control.

With Fixed and Heater lamps ON, the bath temperature begins rising and the operation begins.

### 4. Stop operation.

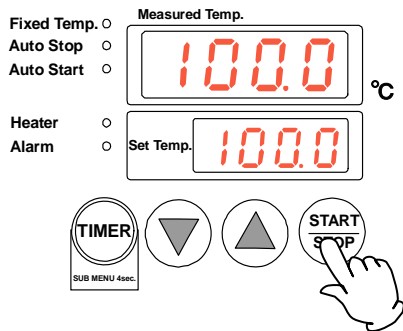

Keep pressing the **START/STOP** key.

Fixed Temp. and Heater lamps go OFF and the operation stops.

Fixed and Heater lamps go OFF and the operation stops.

**The temperature can be set over a range from 0.0°C to 200.0°C.**

**Note however that the operating temperature range is from the room temperature + 5.0°C up to 200.0°C.**

<b>Displays of the operation panel used for fixed-value operation</b>	POWER switch	:	With this switch ON, the power is supplied to the system. With the switch OFF, power supply is turned OFF. This switch is a
	▼ and ▲ keys	:	circuit breaker.
	Measured Temp. screen	:	Key to change the set temperature.
	Set Temp. screen	:	Shows the current bath temperature.
	Fixed Temp. lamp	:	Shows the set temperature.
	Heater lamp	:	Indicates that the fixed-value operation state is under way.
	START/STOP key	:	ON with the heater energized and flashing for the controlled state Operation start/stop key. Keep pressing for a certain period.

# 2. How to operate the unit

## Quick auto-stop operation

### For quick auto-stop operation

In this mode, the fixed-value operation being under way is stopped automatically with the timer setting.

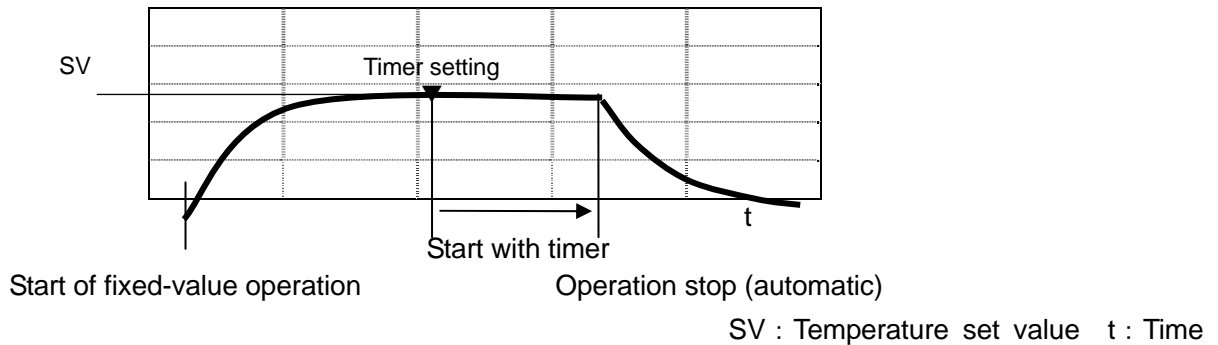

The quick auto-stop operation is performed in the fixed-value operation mode.

### 1. Start operation.

Press lightly the **TIMER** key during fixed-value operation. The Set Temp. screen changes to display the time and flashes, with the Auto Stop lamp entering the flash state.

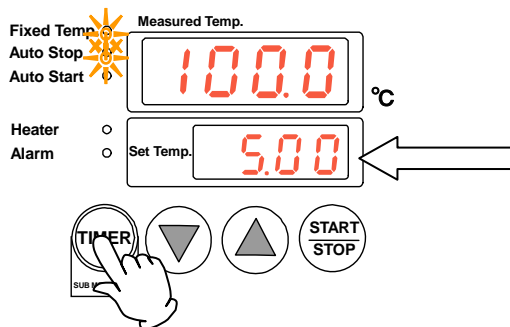

The time set immediately before the operation is shown.

### 2. Set the desired time.

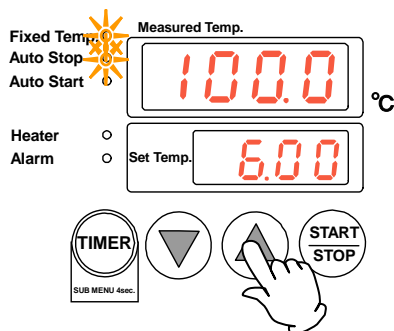

Set the desired time with ▼ and ▲ keys.

The timer can be set over a range from 0.01 (1 minute) to 999.5 (999 hours 50 minutes) . The timer indicates the time in minutes from 0.01 to 99.59 and in ten minutes from 100.0 to 999.5.

# 2. How to operate the unit

## Quick auto-stop operation

### 3. Start the auto-stop time.

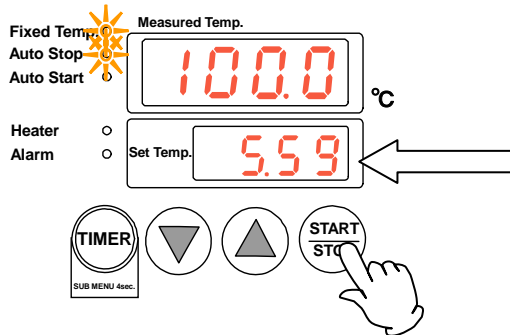

Press the **START/STOP** key.

The Auto Stop lamp changes from flashing to the continuous ON state, and auto-stop operation begins. The timer starts counting when the bath temperature reaches the set level.

The display changes from the set time to the remaining time.

### 4. Time-up

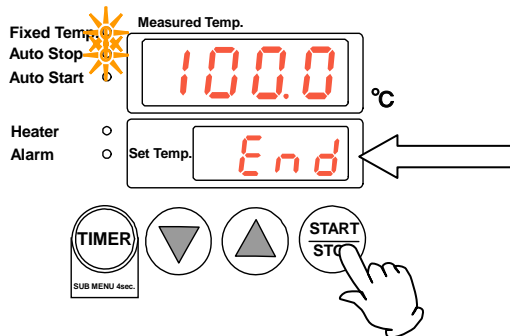

At the set time, the display changes from the remaining time to the flashing display of End **End**. This means the end of auto-stop operation.

The display changes to End **End**.

### 5. End of the quick auto-stop operation

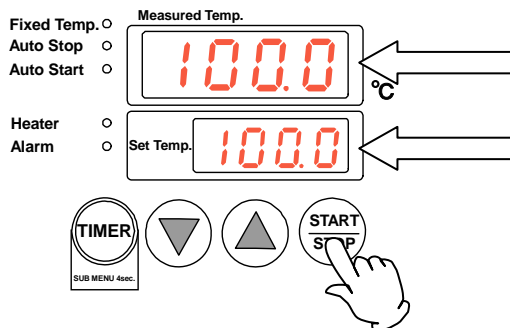

To cancel the quick auto-stop operation, keep pressing the **START/STOP** key. The operation ends and the screen returns to the temperature setting screen.

Indicates the current bath temperature.

Indicates the current set temperature.

### Counting of the timer during the quick auto-stop operation

When the temperature set in the quick auto-stop operation is lower than the bath temperature, the timer does not start counting till the bath temperature reaches the set level.

## 2. How to operate the unit

### Quick auto-stop operation

<b>Displays of the operation panel used for quick auto-stop operation</b>	POWER switch	: With this switch ON, the power is supplied to the system. With the switch OFF, power supply is turned OFF. This switch is a circuit breaker.
	▼ and ▲ keys	: Key to change the set temperature or the time of timer
	Measured Temp. screen	: Indicates the current bath temperature.
	Set Temp. screen	: Indicates the set temperature. Indicates the set and remaining times of the timer.
	Fixed Temp. lamp	: Indicates that the operation is in the fixed-value mode.
	Auto Stop lamp	: ON during auto-stop operation and flashing for the time period set with the timer
	Heater lamp	: ON with heater energized and flashing in the controlled state Operation start/stop key. Keep pressing for a certain period.
	START/STOP key	: This is also a timer start key for addition of auto-stop timer operation in the fixed-value operation mode. Key to set the time during setting of the auto-stop timer. Press the TIMER key lightly to show the timer set time.
	TIMER key	

# 2. How to operate the unit

## Auto-stop operation

### For the auto-stop operation

In this mode, the operation stops automatically according to the setting of the timer.

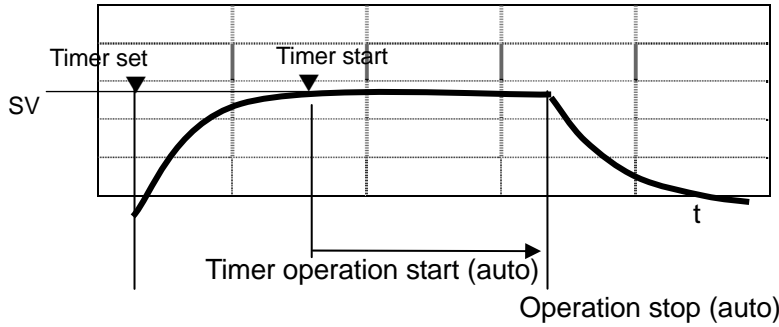

SV : Temperature set value t : Time

Quick auto-stop function is to set auto-stop in the course of fixed-value operation. This section describes the method of operation, in which the auto-stop timer is set at the initial set time point.

1. Turn ON the **POWER** switch to start power supply.

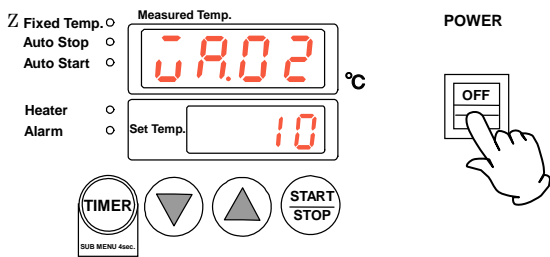

The initial screen is shown for four seconds.

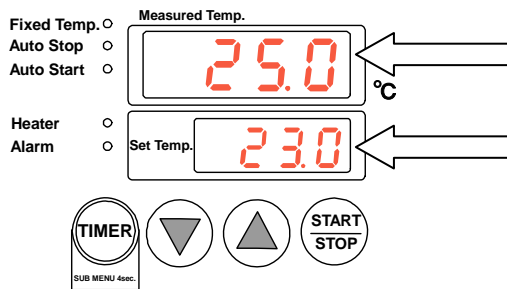

The temperature setting screen appears after the initial screen has been shown for four seconds.

Indicates the current bath temperature.

Indicates the current set temperature.

# 2. How to operate the unit

## Auto-stop operation

### 2. Set the temperature.

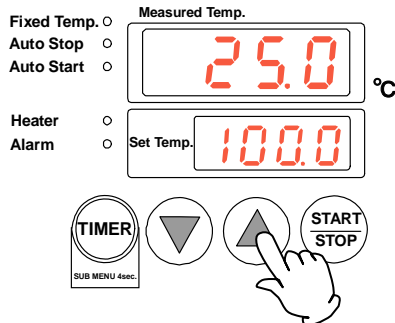

Set the desired temperature with ▼ and ▲ keys.

The set temperature rises with the ▲ key and lowers with the ▼ key.

The temperature can be changed even in the course of operation.

### 3. Select the auto-stop mode.

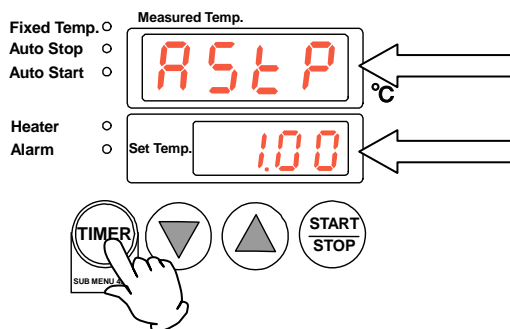

Press the **TIMER** key lightly to allow the AStP **ASTP** indicating the auto-stop operation mode to appear. The Set Temp. screen shows the time.

Indicates AStP **ASTP** that means the auto-stop operation mode.

Indicates the time set immediately before operation.

### 4. Set the time of the timer.

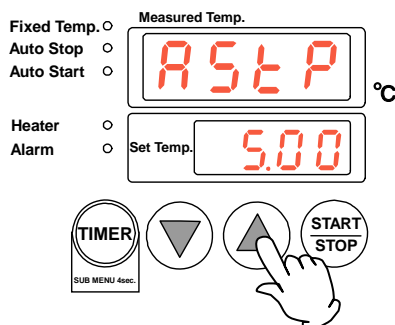

Set the time with ▼ and ▲ keys.

The time display screen changes to flashing and the screen changes to the time setting screen.

The timer can set over a range from 0.01 (1 minute) to 999.5 (999 hours 50 minutes) .  
The timer indicates the time in minutes from 0.01 to 99.59 and in ten minutes from 100.0 to 999.5.



## 2. How to operate the unit

### Auto-stop operation

#### 5. Start the auto-stop operation.

Keep pressing the **START/STOP** key.

Auto-stop operation begins.

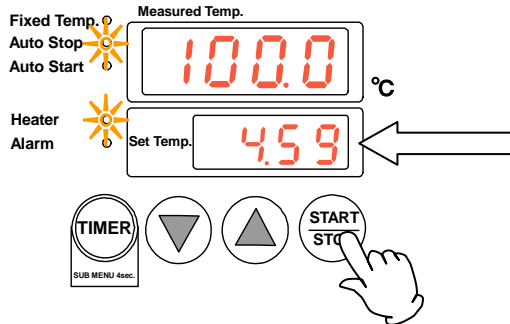

The timer starts counting when the set temperature is reached.

#### ▪ Starting counting of the timer in the auto-stop operation mode

When the set temperature is lower than the bath temperature in the auto-stop operation mode, the timer does not start counting till the bath temperature reaches the set temperature.

#### ▪ The set temperature and the time of timer can be changed even during operation.

Change the set temperature directly with ▼ and ▲ keys. The display changes from the remaining time to the temperature setting screen, enabling temperature change. The screen changes automatically to the remaining time display. There is not need to press the **START/STOP** key after change.

To change the time of timer, press lightly the **TIMER** key. The set time display flashes. Change the time to the desired time with ▼ and ▲ keys. The screen changes automatically to the remaining time display. There is not need to press the **START/STOP** key after change.

#### 6. Time-up

At the set time, the remaining time display changes to the flashing display of End **End**. This means the end of the auto-stop operation.

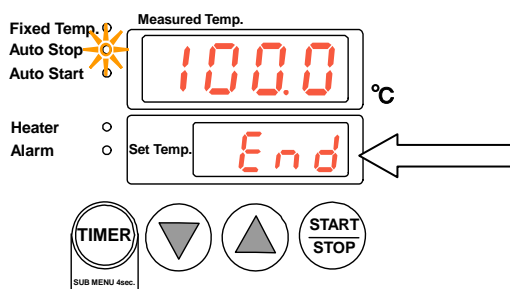

Changes over to End **End**.

## 2. How to operate the unit

### Auto-stop operation

#### 7. End of the auto-stop operation

To cancel the auto-stop operation, keep pressing the **START/STOP** key. The operation ends and the screen returns to the temperature setting screen.

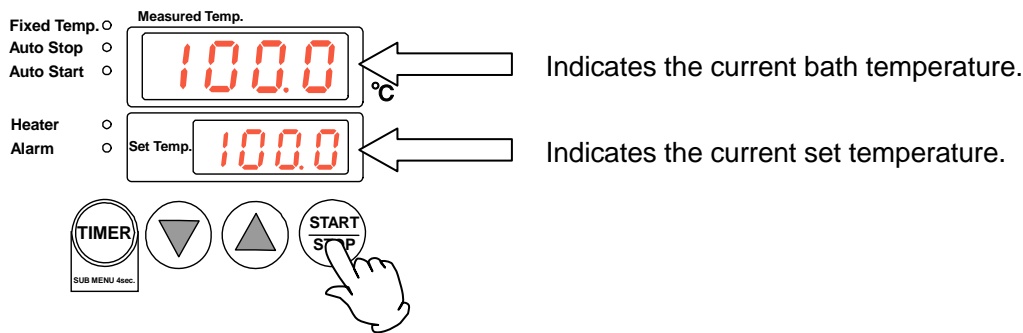

<b>Displays of the operation panel used for auto-stop operation</b>	POWER switch	: With this switch ON, the power is supplied to the system. With the switch OFF, power supply is turned OFF. This switch is a circuit breaker.
	▼ and ▲ keys	: Key to change the set temperature or the time of timer.
	Measured Temp. screen	: Indicates the current bath temperature.
	Set Temp. screen	: Indicates the set temperature. Indicates the set and remaining times of the timer.
	Auto Stop lamp	: ON during auto-stop operation
	Heater lamp	: ON with heater energized and flashing in the controlled state
	START/STOP key	: Operation start/stop key. Keep pressing for a certain period.
TIMER key	: This is a key to set the time of timer during setting of the auto-stop timer. Press the <b>TIMER</b> key lightly during fixed-value operation to show the timer set time.	

# 2. How to operate the unit

## Auto-start operation

### For the auto-start operation

This mode is selected when the operation is to be started automatically in several hours later as shown below. Since the operation does not stop automatically, it is necessary to stop it manually.

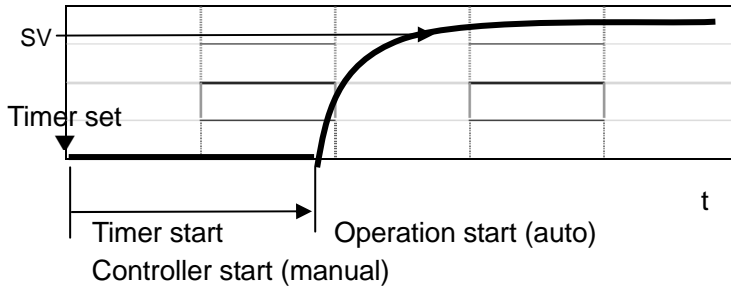

SV : Temperature set value t : Time

### 1. Turn ON the **POWER** switch to start power supply.

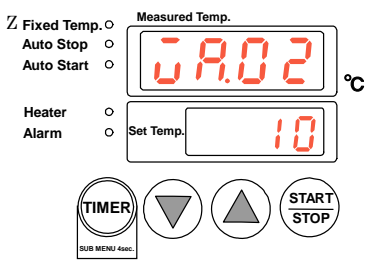

POWER

The initial screen is shown for four seconds.

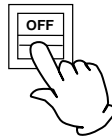

The temperature setting screen appears after the initial screen has been shown for four seconds.

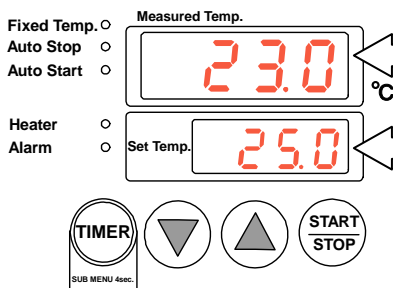

Indicates the current bath temperature.

Indicates the current set temperature.

# 2. How to operate the unit

## Auto-start operation

### 2. Set the temperature.

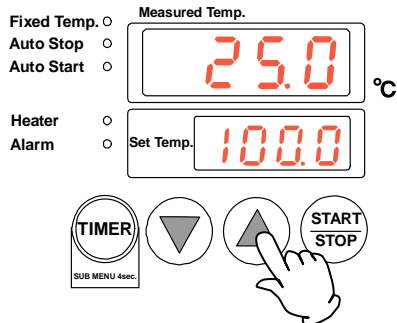

Set the desired temperature with ▼ and ▲ keys.

The set temperature rises with the ▲ key and lowers with the ▼ key.

The temperature can be changed even in the course of operation.

### 3. Select the auto-start mode.

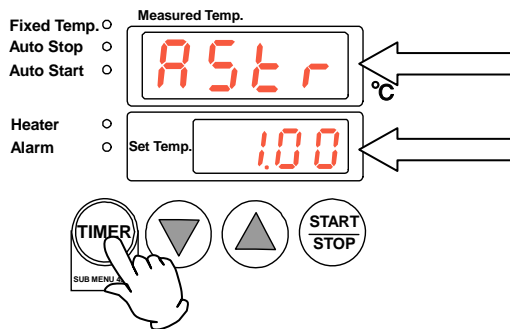

Press the **TIMER** key lightly to allow AStr AStr indicating the auto-stop operation mode to appear. The time is shown in the Set Temp. screen.

Indicates AStr AStr meaning the auto-stop operation mode.

Indicates the time set immediately before operation.

### 4. Set the time of timer.

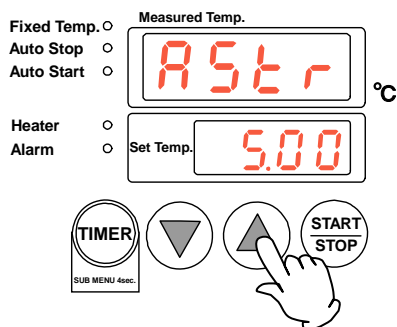

Set the time with ▼ and ▲ keys.

The time display screen changes to flashing and the screen changes to the time setting screen.

The timer can set over a range from 0.01 (1 minute) to 999.5 (999 hours 50 minutes) . The timer indicates the time in minutes from 0.01 to 99.59 and in ten minutes from 100.0 to 999.5.

## 2. How to operate the unit

### Auto-start operation

#### 5. Start the auto-start operation.

Keep pressing the **START/STOP** key.  
Auto-start operation begins.

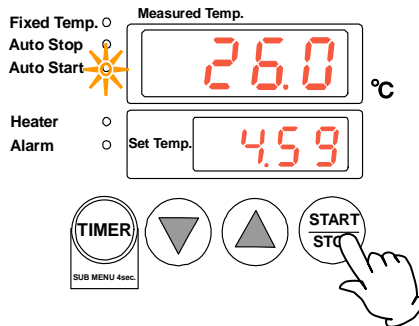

#### 6. Time-up

At the set time, the set temperature is shown in the Set Temp. screen.

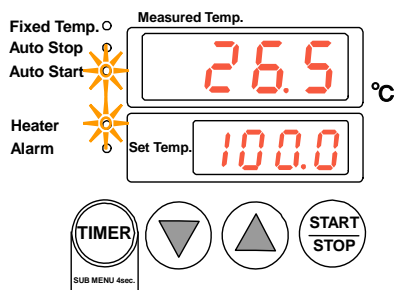

#### 7. End of the auto-start operation.

To cancel the auto-start operation, keep pressing the **START/STOP** key. The operation ends and the screen returns to the temperature setting screen.

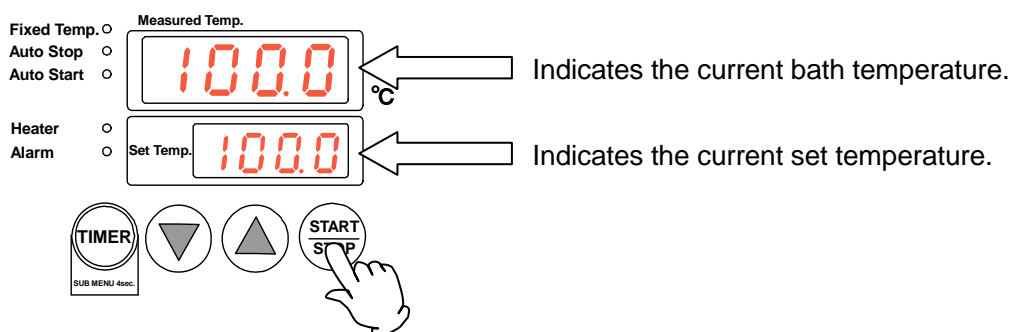

## 2. How to operate the unit

### Auto-start operation

<b>Displays of the operation panel used for auto-start operation</b>	POWER switch	: With this switch ON, the power is supplied to the system. With the switch OFF, power supply is turned OFF. This switch is a circuit breaker.
	▼ and ▲ keys	: Key to change the set temperature or the time of timer.
	Measured Temp. screen	: Indicates the current bath temperature.
	Set Temp. screen	: Indicates the set temperature. Indicates the set and remaining times of the timer.
	Auto Start lamp	: ON during auto-start operation
	Heater lamp	: ON with heater energized and flashing in the controlled state
	START/STOP key	: Operation start/stop key. Keep pressing for a certain period.
	TIMER key	: This is a key to set the time of timer during setting of the auto-stop timer. Press the <b>TIMER</b> key lightly during fixed-value operation to show the timer set time so as to show the time set with timer.

# 2. How to operate the unit

## Other functions

### Over-temperature preventive function

<b>This product incorporates two types of over-temperature preventive functions.</b>	
1. Automatic over-temperature preventive device	<p>Before shipment, this device has been set in such a manner that it interlocks with the set temperature of the device and is activated automatically at the set temperature + 12°C in case of abnormal rising of bath temperature.</p> <p>When activated, the over-temperature preventive function causes stop of operation and flashing of the Alarm lamp. To cancel the function, turn ON the Power switch newly again after allowing the bath temperature to lower (manual reset).</p> <p>When the symptom is not improved, the circuitry (temperature controller, etc.) may be faulty. Contact a shop from which you have purchased the product, our sales office, or our customer service center.</p>
2. Independent over-temperature preventive device	<p>If abnormal overheat continues because of failure of the automatic over-temperature preventive function, resulting in the bath temperature rise up to 230 °C, the built-in bimetal over-temperature preventive device is activated, shutting off power supply to the heater.</p> <p>Activation of this device may be due to failure of the circuitry (temperature controller, etc.). Contact a shop from which you have purchased the product, our sales office, or our customer service center.</p>

### Set value lock function

This function is to lock the set contents to prevent arbitrary change.

#### 1. Select the Lock function from the sub-menu function.

Keep pressing the **TIMER** key for four seconds and select the sub-menu mode. Allow Lock **LoCh** indicating the set-value lock function to appear. The Set Temp. screen shows off **oFF** when no setting has been made and on **oN** when any setting has been made.

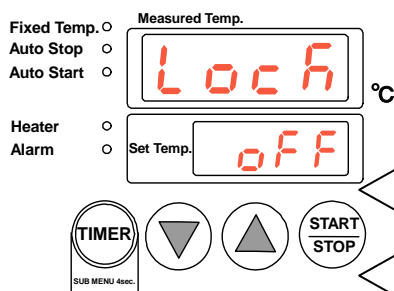

Shows Lock **LoCh** indicating the set-value lock mode.

Shows either off **oFF** or on **oN**.



# 2. How to operate the unit

## Other functions

### 2.Lock the set value.

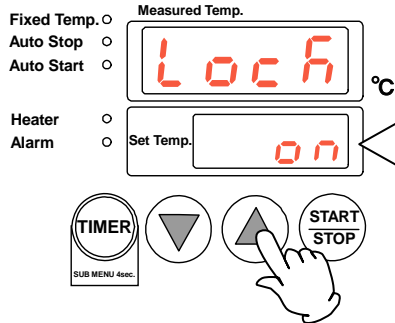

Select "on" with the ▲ key, and the set value is locked.

Shows on **on**.

### 3. Cancel the Lock function.

Keep pressing the **TIMER** key for four seconds to select

the sub-menu mode and to allow Lock **Lock** indicating the set-value lock function to appear. The Set

Temp. screen shows off **off**.

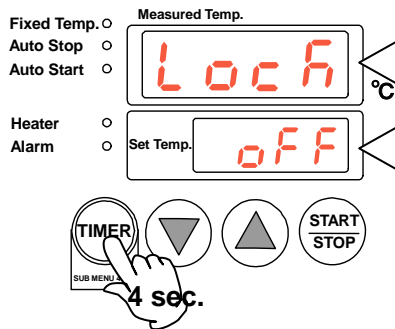

Shows Lock **Lock** indicating the set-value lock mode.

Shows off **off**.



## 2. How to operate the unit

### Other functions

#### Calibration offset function

The calibration offset function is to ensure agreement between the bath temperature and set temperature by compensating the temperature difference, if any, between the bath temperature actually measured with the reference thermometer or temperature recorder and the temperature set with the controller (as read on the controller).

Enter the plus-side temperature difference to the calibration offset setting when the bath temperature exceeds the set value and the minus-side temperature difference to the above setting when the bath temperature is lower than the set level.

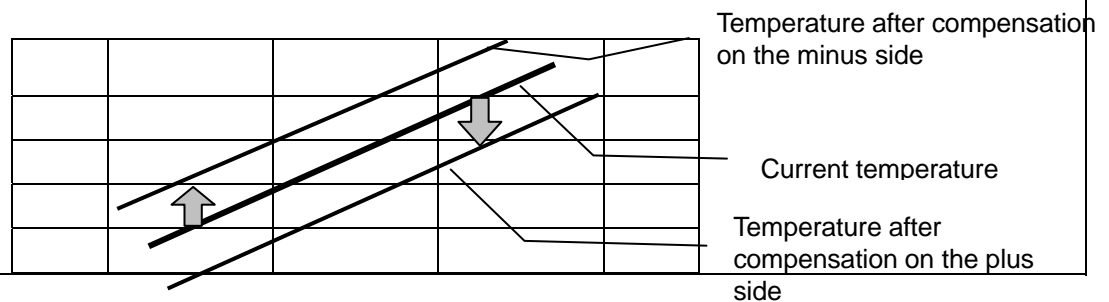

#### 1. Measure the bath temperature

Wait till the bath temperature stabilizes, then check the difference between the bath temperature and the measurement indicator of this device. The bath temperature can be measured correctly by using the calibrated temperature recorder in the small amount of silicone oil filled into the aluminum block.

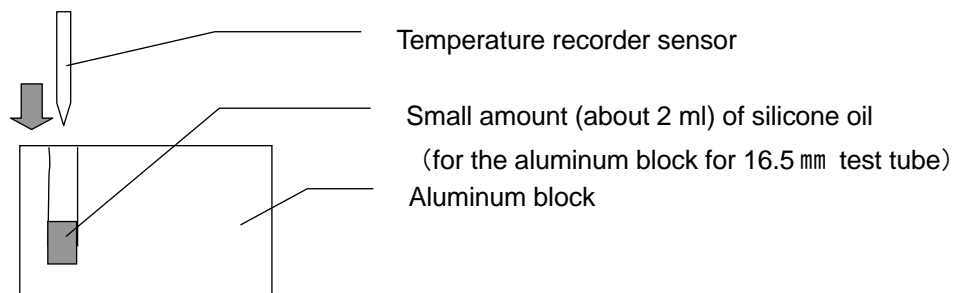

# 2. How to operate the unit

## Other functions

### 2. Select the calibration offset function from the sub-menu function.

Keep pressing the **TIMER** key for four seconds to select the sub-menu mode. First, the set-value lock function is displayed. Press the **TIMER** key again, and **cAL**  indicating the calibration offset function appears.

The Set Temp. screen shows the compensation temperature.

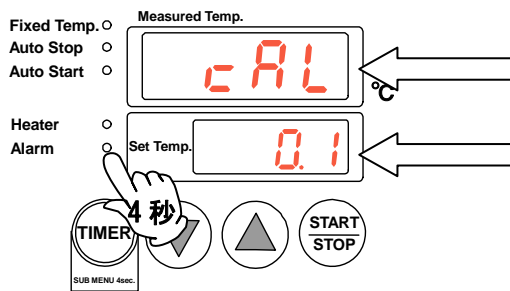

Shows **cAL**  indicating the calibration offset mode.

Shows the offset temperature set immediately before operation.

### 3. Enter the offset temperature.

Enter the temperature difference on the minus side when the bath temperature is lower than the temperature controller reading value.

Enter the temperature difference on the plus side when the bath temperature is higher than the temperature controller reading value.

Repeat this step till the bath temperature and the temperature controller reading value agree. Setting can be completely within a short period by first entering the compensation temperature lower than the difference of both of them, then by allowing it to approach the target level gradually.

Enter the temperature difference in the Set Temp. screen.

Upon completion of the setting, keep pressing the **TIMER** key. The screen returns to the temperature setting screen.

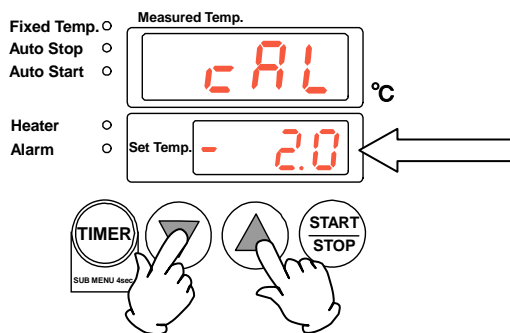

Enter the temperature difference.

# 3. In Case of Trouble

## Error display

The controller displays the following errors.

In case of error, the heater output stops, the **Alarm** lamp flashes to notify abnormality.

Record the error code, turn OFF power supply, and carry out the service call.

Error code		Details	
Er01	Er 01	Temperature input circuit error Temperature sensor error Error of outside the measured temperature display range	Broken or disconnected wire of temperature sensor, error in the temperature input circuit Check the sensor and temperature controller and replace if necessary. Cancelled by resetting power supply.
Er15	Er 15	Memory error	Memory set value error in the temperature controller Board replacement necessary.
Not displayed	<b>Alarm</b> lamp flashing only	Over-temperature prevention error	Abnormal temperature rise, resulting in activation of the auto over-temperature preventive device Cancelled by resetting power supply.
Not displayed	—	Over-temperature prevention error	Abnormal temperature rise, resulting in activation of the independent over-temperature preventive device Carry out the service call.

For details of over-temperature preventive device, refer to P.19.

## Troubleshooting guide

### Troubleshooting

Symptom	Countermeasure
No startup even with <b>POWER</b> and <b>START/STOP</b> keys ON	<ul style="list-style-type: none"> <li>• Check if the master power supply is ON.</li> <li>• Check if power failure has occurred.</li> </ul>

- ◆ If neither of above two cases applies, turn OFF the **POWER** switch immediately. Disconnect the power plug and contact a shop from which you have purchased the product, our sales office, or our customer service center.

## 4. Specifications

### Main body

Type	HF100	HF200
No. of installed aluminum blocks	1 piece	2 pieces
Operating temperature range	Room temperature + 5.0°C~200.0°C	
Temperature control accuracy	±0.2°C (16.5φ block used)	±0.2°C (16.5φ block used)
Temperature rise time	About 30 minutes (room temperature at 23°C)	About 35 minutes (room temperature at 23°C)
Temperature controller	PID control with microcomputer	
Temperature setting method	▲ and ▼ keys	
Minimum temperature setting	0.1°C	
Temperature setting method	7-segment LED, set temperature, and bath temperature displayed	
Heater	370W	600W
Sensor	Pt100Ω	
Safety devices	Functioning both as POWER switch and circuit breaker	
	Automatic over-temperature preventive function (main relay OFF at the set temperature + 12°C, manual reset) Independent over-temperature preventive device (manual reset type bimetal, activated temperature at about 230°C)	
Functions	Fixed-value operation, quick auto-stop operation, auto-stop operation, auto-start operation, self-diagnosis function, automatic over-temperature preventive function, set-value lock function, calibration offset function, power failure compensation function	
Overall dimensions	About 230W × 310D × 139H	About 340W × 310D × 139H
Internal dimensions bath	About 112W × 112D × 70H	About 222W × 112D × 70H
Weight	About 5 kg	About 6.5 kg
Power supply	AC100V 3.8A±10%	AC100V 6.1A±10%
Accessories	Heating block mounting/removal fixture, operation manual, warranty card	

※ The temperature control accuracy has been determined according to our testing method.  
This is the value measured using an aluminum block for 16.5 mm test tube at the room temperature of 23°C.

### Optional accessories

Aluminum block dimensions		110W × 110D × 70H (common to all blocks)			
Types of aluminum block	No.	Product code	Type	Aluminum block specification	No. of racks
	1	213173	OBH80	For 0.5m micro tube	48
	2	213174	OBH82	For 1.5m micro tube	36
	3	213181	OBH84	For 12 mm test tube (common to HF21/41/61)	36
	4	213182	OBH86	For 15 mm test tube (common to HF21/41/61)	25
	5	213183	OBH88	For 16.5 mm test tube (common to HF21/41/61)	25
	6	213184	OBH90	For 18 mm test tube (common to HF21/41/61)	20
	7	213175	OBH92	For 21 mm test tube	12
	8	213176	OBH94	For 24 mm test tube	12
	9	213185	OBH96	For 25 mm test tube (common to HF21/41/61)	12
10	213177	OBH98	For 30 mm test tube	8	

## 5. Wiring Diagram

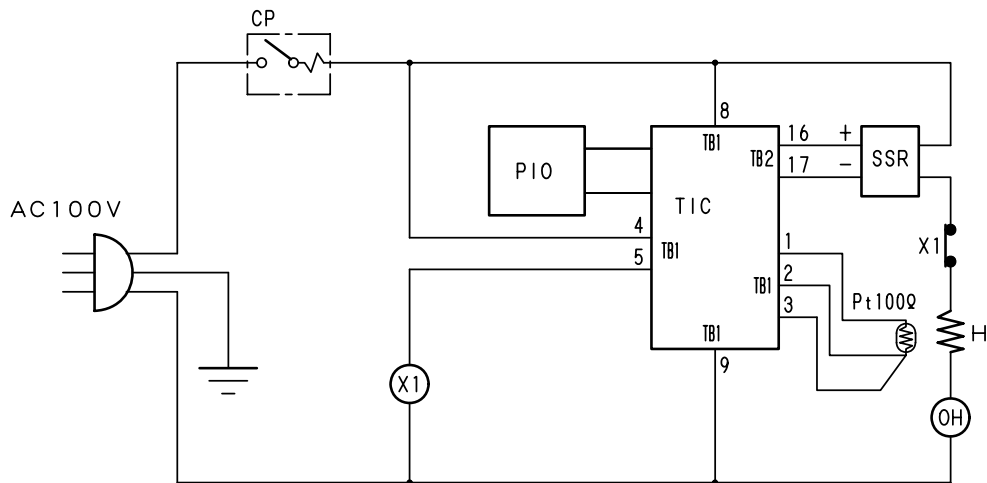

Symbol	Name of part	Symbol	Name of part
H	Mica heater	X1	Main relay
TIC	Control board	SSR	Non-contact relay
PIO	Display board	Pt100Ω	Temperature sensor
CP	POWER switch (circuit breaker)	OH	Bimetal type Over-temperature preventive device