

Yamato

Muffle Furnace

Model

**FO 100/200/300/310/410
/510/610/710/810**

Instruction Manual

- Third Edition -

- Thank you for purchasing "Muffle Furnace, FO Series" of Yamato Scientific Co., Ltd.
- To use this unit properly, read this "Instruction Manual" thoroughly before using this unit. Keep this instruction manual around this unit for referring at anytime.



WARNING!:

Carefully read and thoroughly understand the important warning items described in this manual before using this unit.

Yamato Scientific Co. LTD.,

Contents

◆ Cautions in Using with Safety	1
• Explanation.....	1
• Table of Illustrated Symbols	2
• Fundamental Matters of "WARNING!" and "CAUTION!"	3
◆ Before Using this unit	4
• Requirements for Installation.....	4
◆ Description and Function of Each Part	7
• Main Unit	7
• Control Panel.....	8
• Characters of the Controller	9
◆ Operation Method	10
• Operation Mode and Function List	10
• Operation Mode, Function Setting Key, and Characters	11
• Fixed Temperature Operation.....	12
• Quick Auto Stop Operation.....	13
• Auto Stop Operation.....	14
• Auto Start Operation.....	16
• Program Operation.....	18
• Temperature Rise/Fall Curve (Reference).....	23
• Program Operation.....	26
• Other Functions.....	28
◆ Handling Precautions	30
◆ Maintenance Method	32
• Daily Inspection and Maintenance	32
◆ Long storage and disposal	33
• When not using this unit for long term / When disposing	33
◆ In the Event of Failure	34
• Safety Device and Error Code.....	34
• Trouble Shooting	35
◆ After Service and Warranty	36
◆ Specification	37
• FO100/200/300/310/410	37
• FO510/610/710/810	38
• Optional Accessories.....	39
◆ Wiring Diagram	40
◆ Replacement Parts Table	43
◆ Reference	45
• List of Dangerous Substances	45

Explanation

MEANING OF ILLUSTRATED SYMBOLS

Illustrated Symbols

Various symbols are used in this safety manual in order to use the unit without danger of injury and damage of the unit. A list of problems caused by ignoring the warnings and improper handling is divided as shown below. Be sure that you understand the warnings and cautions in this manual before operating the unit.

 **WARNING!** If the warning is ignored, there is the danger of a problem that may cause a serious accident or even fatality.

 **CAUTION!** If the caution is ignored, there is the danger of a problem that may cause injury/damage to property or the unit itself.

Meaning of Symbols



This symbol indicates items that urge the warning (including the caution). A detailed warning message is shown adjacent to the symbol.



This symbol indicates items that are strictly prohibited. A detailed message is shown adjacent to the symbol with specific actions not to perform.



This symbol indicates items that should be always performed. A detailed message with instructions is shown adjacent to the symbol.

Cautions in Using with Safety

Table of Illustrated Symbols

Warning



Warning,
generally

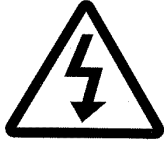

Warning,
high voltage



Warning,
high temperature



Warning,
drive train



Warning,
explosive

Caution



Caution,
generally



Caution,
electrical shock



Caution,
scald



Caution,
no road heating



Caution,
not to drench



Caution,
water only



Caution,
deadly poison

Prohibit



Prohibit,
generally



Prohibit,
inflammable



Prohibit,
to disassemble



Prohibit,
to touch

Compulsion



Compulsion,
generally



Compulsion,
connect to the
grounding
terminal



Compulsion,
install on a flat
surface



Compulsion,
disconnect the
power plug



Compulsion,
periodical
inspection

Cautions in Using with Safety

Fundamental Matters of "WARNING!" and "CAUTION!"

WARNING!

Do not use this unit in an area where there is flammable or explosive gas

Never use this unit in an area where there is flammable or explosive gas. This unit is not explosion-proof. An arc may be generated when the power switch is turned on or off, and fire/explosion may result. (Refer to page 45 "List of Dangerous Substances".)

Always ground this unit

Always ground this unit on the power equipment side in order to avoid electrical shock due to a power surge.

If a problem occurs

If smoke or strange odor should come out of this unit for some reason, turn off the power key right away, and then turn off the circuit breaker and the main power. Immediately contact a service technician for inspection. If this procedure is not followed, fire or electrical shock may result. Never perform repair work yourself, since it is dangerous and not recommended.

Do not use the power cord if it is bundled or tangled

Do not use the power cord if it is bundled or tangled. If it is used in this manner, it can overheat and fire may be caused.

Do not process, bend, wring, or stretch the power cord forcibly

Do not process, bend, wring, or stretch the power cord forcibly. Fire or electrical shock may result.

Do not disassemble or modify this unit

Do not disassemble or modify this unit. Fire or electrical shock or failure may be caused.

Do not touch high-temperature parts

The inside of the body or the door may become hot during and just after operation. It may cause burns.

CAUTION!



During a thunder storm

During a thunderstorm, turn off the power key immediately, then turn off the circuit breaker and the main power. If this procedure is not followed, fire or electrical shock may be caused.



Requirements for Installation

WARNING!

1. Always ground this unit

-  • Connect the power plug to a receptacle with grounding connectors.
-  • Do not forget to ground this unit, to protect you and the unit from electrical shock in case of power surge. Choose a receptacle with grounding connectors as often as possible.
- Do not connect the grounding wire to a gas pipe, or by means of a lightning rod or telephone line. A fire or electrical shock will occur.
- Though FO200/300 model is the 100V single phase model, these two models have the large electric capacity (over 15A). Be sure to prepare the power switchboard with the specific grand earth or specific receptacle which has electric capacity over 20A.
- FO310/410/510/610/710/810 model is the 200V single phase mode. Be sure to connect this model to the specific power switchboard or receptacle for 200V.

2. Choose a proper place for installation

-  • Do not install this unit in a place where:
 - ◆ Rough or dirty surface.
 - ◆ Flammable gas or corrosive gas is generated.
 - ◆ Ambient temperature exceeds 35°C.
 - ◆ Ambient temperature fluctuates violently.
 - ◆ There is direct sunlight.
 - ◆ There is excessive humidity and dust.
 - ◆ There is a constant vibration.
-  • Install this unit on a stable place with the space as shown below.

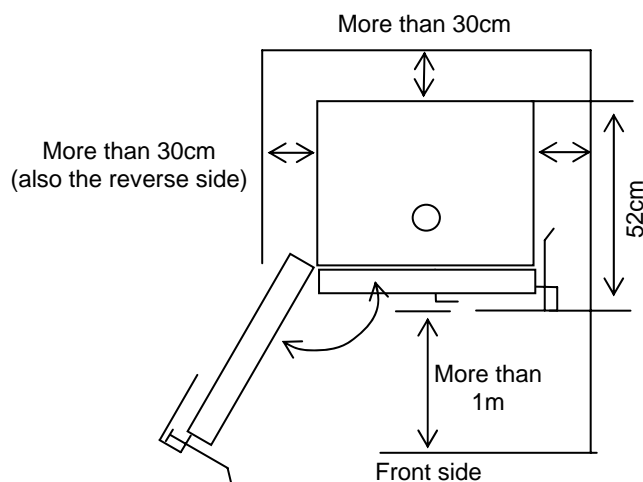

Requirements for Installation

3. Do not use this unit in an area where there is flammable or explosive gas



- Never use this unit in an area where there is flammable or explosive gas. This unit is not explosion-proof. An arc may be generated when the power switch is turned ON or OFF, and fire/explosion may result. (Refer to page 45 "List of Dangerous Substances".)

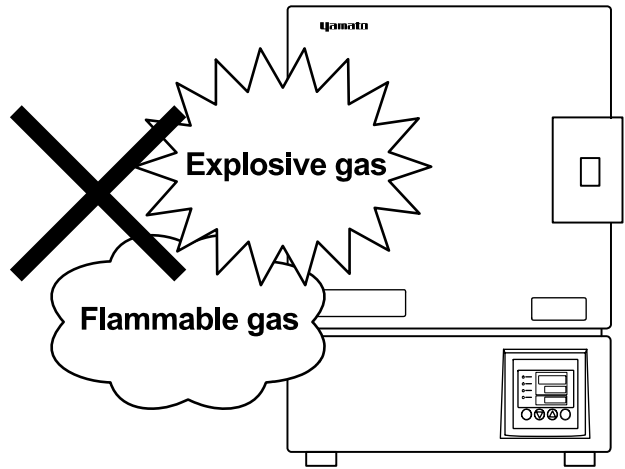

4. Do not modify



- Modification of this unit is strictly prohibited. This could cause a failure.

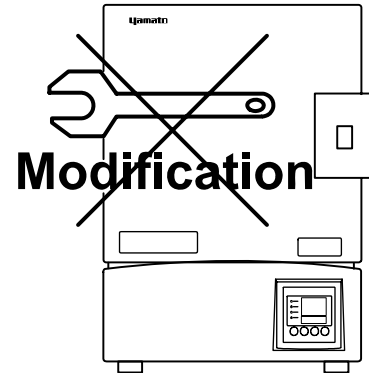

5. Installation on horizontal surface



- Set this unit to the flattest place. Not setting this unit with its legs contacted to the setting place surface evenly could cause the vibration or noise, or cause the unexpected trouble or malfunction.

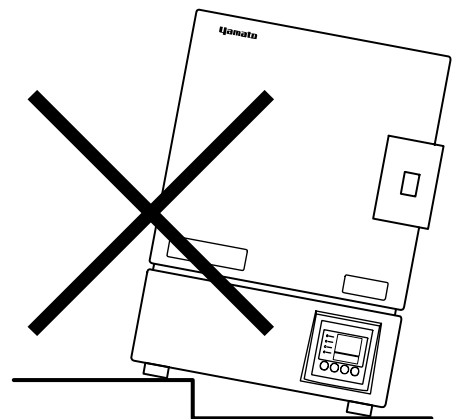

Requirements for Installation

6. Choose a correct power distribution board or receptacle



- Choose a correct power distribution board or receptacle that meets the unit's rated electric capacity.

<u>Electric capacity :</u>	FO100:	AC100 V, 11A
	FO200:	AC100 V, 16A
	FO300:	AC100 V, 21A
	FO310:	AC200 V (Single phase), 11A
	FO410:	AC200 V (Single phase), 12A
	FO510:	AC200 V (Single phase), 13.5A
	FO610:	AC200 V (Single phase), 16A
	FO710:	AC200 V (Single phase), 18.5A
	FO810:	AC200 V (Single phase), 21A

NOTE)

There could be the case that the unit does not run even after turning ON the power. Inspect whether the voltage of the main power is lowered than the specified value, or whether other device(s) uses the same power line of this unit. If the phenomena might be found, change the power line of this unit to the other power line.

7. Before/after installing



- It may cause injure to a person if this unit falls down or moves by the earthquake and the impact. etc.. To prevent, take measures that the unit cannot fall down, and not install to busy place.
- Touching the unit may cause a burn during and after the operation. To prevent, take measures that putting up a notice of operating etc..

8. Handling of power code



- Do not entangle the power cord. This will cause overheating and possibly a fire.
- Do not bend or twist the power cord, or apply excessive tension to it. This may cause a fire and electrical shock.
- Do not lay the power cord under a desk or chair, and do not allow it to be pinched in order to prevent it from being damaged and to avoid a fire or electrical shock.
- Keep the power cord away from any heating equipment such as a room heater. The cord's insulation may melt and cause a fire or electrical shock.



- If the power cord becomes damaged (wiring exposed, breakage, etc.), immediately turn off the power at the rear of this unit and shut off the main supply power. Then contact your nearest dealer for replacement of the power cord. Leaving it may cause a fire or electrical shock.
- Connect the power plug to the outlet which is supplied appropriate power and voltage.

Description and Function of Each Part

Main Unit

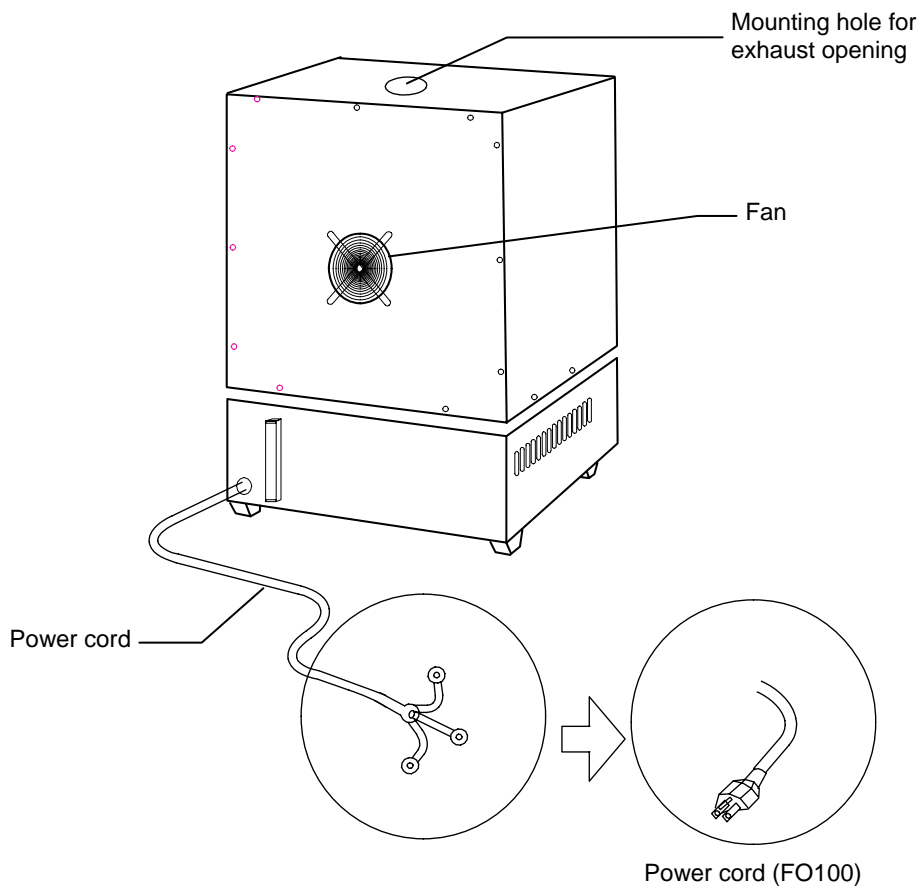
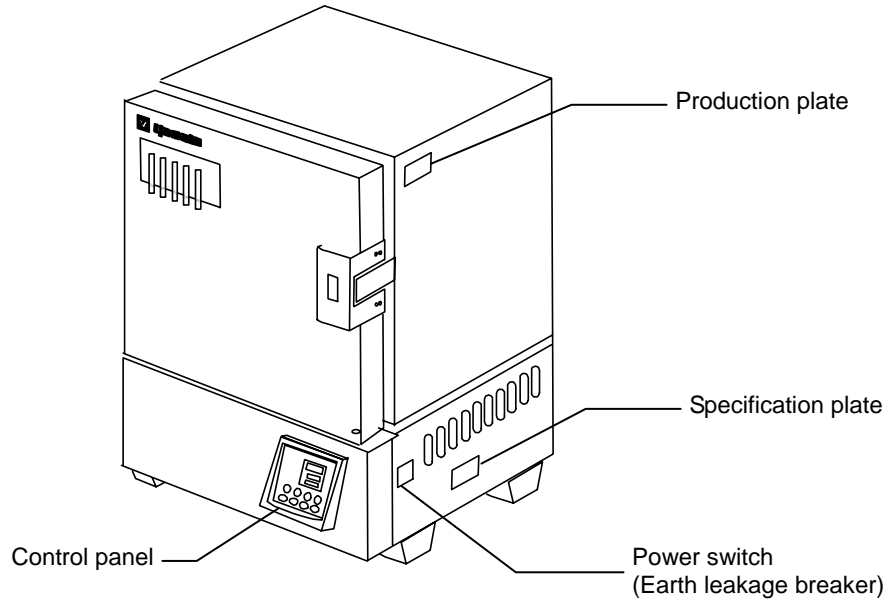

Description and Function of Each Part

Control Panel

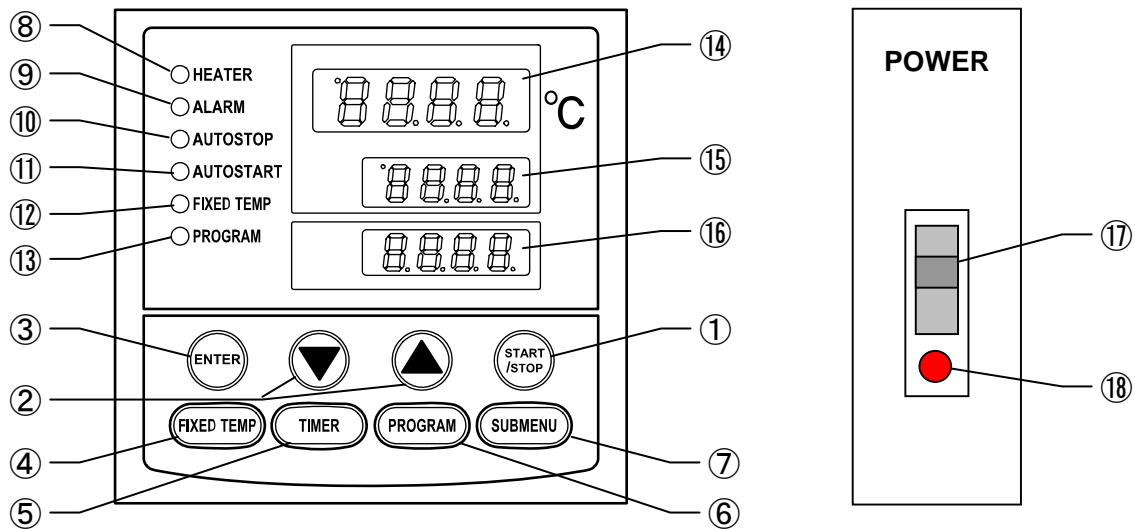











①	START/STOP Key :	Starts/stops the operation.
②	▲▼ Key :	Uses for rising UP/lowering DOWN the setting value.
③	ENTER Key :	Settles the inputted value.
④	FIXED TEMP Key :	Chooses the fixed temperature operation.
⑤	TIMER Key :	Chooses the timer operation (Quick Auto Stop/Auto Stop/Auto Start).
⑥	PROGRAM Key :	Chooses the program operation or program creation mode.
⑦	SUBMENU Key :	Uses for setting the overheating prevention temperature, calibration offset temperature, key lock function, or program repeat function.
⑧	HEATER Lamp :	Lights while the heater works.
⑨	ALARM Lamp :	Lights up when an error occurs. (Buzzer sounds simultaneously.)
⑩	AUTO STOP Lamp :	Blinks while setting quick auto stop timer or auto stop timer. Lights while quick auto stop timer or auto stop timer is running.
⑪	AUTO START Lamp :	Blinks while setting auto start timer. Lights while auto start timer is running.
⑫	FIXED TEMP Lamp :	Blinks while setting fixed temperature operation. Lights while fixed temperature operation is running.
⑬	PROGRAM Lamp :	Blinks while setting program operation. Lights while program operation is running.
⑭	Measurement Temperature Display :	Displays the measured temperature, setting character, alarm information.
⑮	Setting Temperature Display :	Displays the setting temperature, setting value for timer mode, remaining time.
⑯	Overheating Prevention Temperature Display :	Displays the setting temperature for overheating prevention device.
⑰	Power Switch : (Earth leakage breaker)	Turns ON/OFF the main power.
⑱	Electric leak testing button :	Checks the breaker's condition.

Description and Function of Each Part

Characters of the Controller

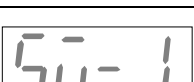
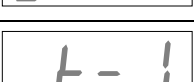
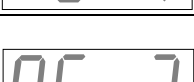
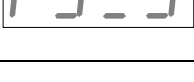
The characters VS4 controller shows are as follows:

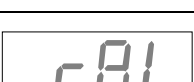
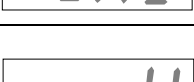
Character	Identifier	Name	Purpose
	FiX	Fixed Temperature Setting Mode	Used for starting the fixed temperature operation.
	Sv	Temperature Setting	Used for setting the temperature.
	AStP	Timer Setting Mode Display	Represents the setting of quick auto stop or auto stop operation.
	AStr	Timer Setting Mode Display	Represents the setting of auto start operation.
	tim	Time Setting	Used for setting the time.
	PrG3	Program Type	Used for choosing program type from 1 to 3. (Refer to Page 18 "Program Operation".)
	PAt	Program Pattern	Used for choosing program pattern. (Refer to Page 18 "Program Operation".)
	End	Time Up	Displays when the timer operation is completed or while inputting number of program steps. (Refer to Page 18 "Program Operation".)
	Sv-1	Program Temperature Setting	Used for setting the temperature for each step in the program. (Sv-1 to Sv-30 is shown.)
	t-1	Program Time Setting	Used for setting the time for each step in the program. (t-1 to t-30 is shown.)
	PS-3	Step Number to be Repeated	Used for choosing the step number to be repeated under the program operation with repeat function. (Refer to Page 22 "Use program repeat function".)
	Pc-2	Repeating Times	Used for setting the repeating times under the program operation with repeat function. (Refer to Page 22 "Use program repeat function".)
	cAL	Calibration Offset Setting	Used for inputting the calibration offset temperature. (Refer to Page 29 "Other Function".)
	oH	Overheating Prevention Setting	Used for setting temperature for overheating prevention device. (Refer to Page 28 "Other Functions Setting of Overheating Prevention Device".)
	LocK	Key Lock	Locks the keys on control panel to protect from unnecessary operation. (Refer to Page 29 "Other Function".)

- Also refer to Pages 10 "Operation Mode and Function List" and 11 "Operation Mode, Function Setting Key, and Characters".

Operation Mode and Function List

All the operation mode of this unit is as follows;

No.	Name	Description	Page
1.	Fixed Temperature Operation	Pressing the FIXED TEMP key enters into the fixed temperature operation setting mode. Pressing it again enters into the temperature setting mode. The "▲▼" are used to set temperature. Pressing the START/STOP key starts or stops operation.	12
2.	Quick Auto Stop Operation	This operation is used to specify the period up to automatic stop during operation. The period up to operation stop can be set by pressing the TIMER key during fixed temperature operation. The "▲▼" are used to set the time. Pressing the START key starts the quick auto stop operation, activates the timer function and stops the operation automatically after specified period.	13
3.	Auto Stop Operation	This operation is used to specify the automatic stop time in the fixed temperature operation. Pressing the TIMER key displays "AS t p". The setting temperature "SV" can be set by pressing the ENTER key. The operation time "tim" can be set by pressing it again. Pressing the START/STOP key starts the auto stop operation.	14
4.	Auto Start Operation	This operation is used to specify the period up to automatic start after power on. Pressing the TIMER key displays "AS t r". The setting temperature "SV" can be set by pressing the ENTER key. The operation time "tim" can be set by pressing it again. Pressing the START/STOP key starts the auto start operation.	16
5.	Program Operation	This operation is used to change the temperature according to the setting temperature and time. Pressing the PROGRAM key displays "PrG1". Press it again to select the program mode. Press the ENTER key to select the pattern "PA t". Press the ENTER key to display "End". Input the number of patterns to be used. Input the temperature and time of patterns "SV-n" and "t-n" respectively.	18

NOTE) This unit is impossible to be changed the mode during the operation. If the mode requires to be changed, stop the operation.

Operation Mode, Function Setting Key, and Characters

The operation mode setting and function setting use the key operation and characters show in the following figure.

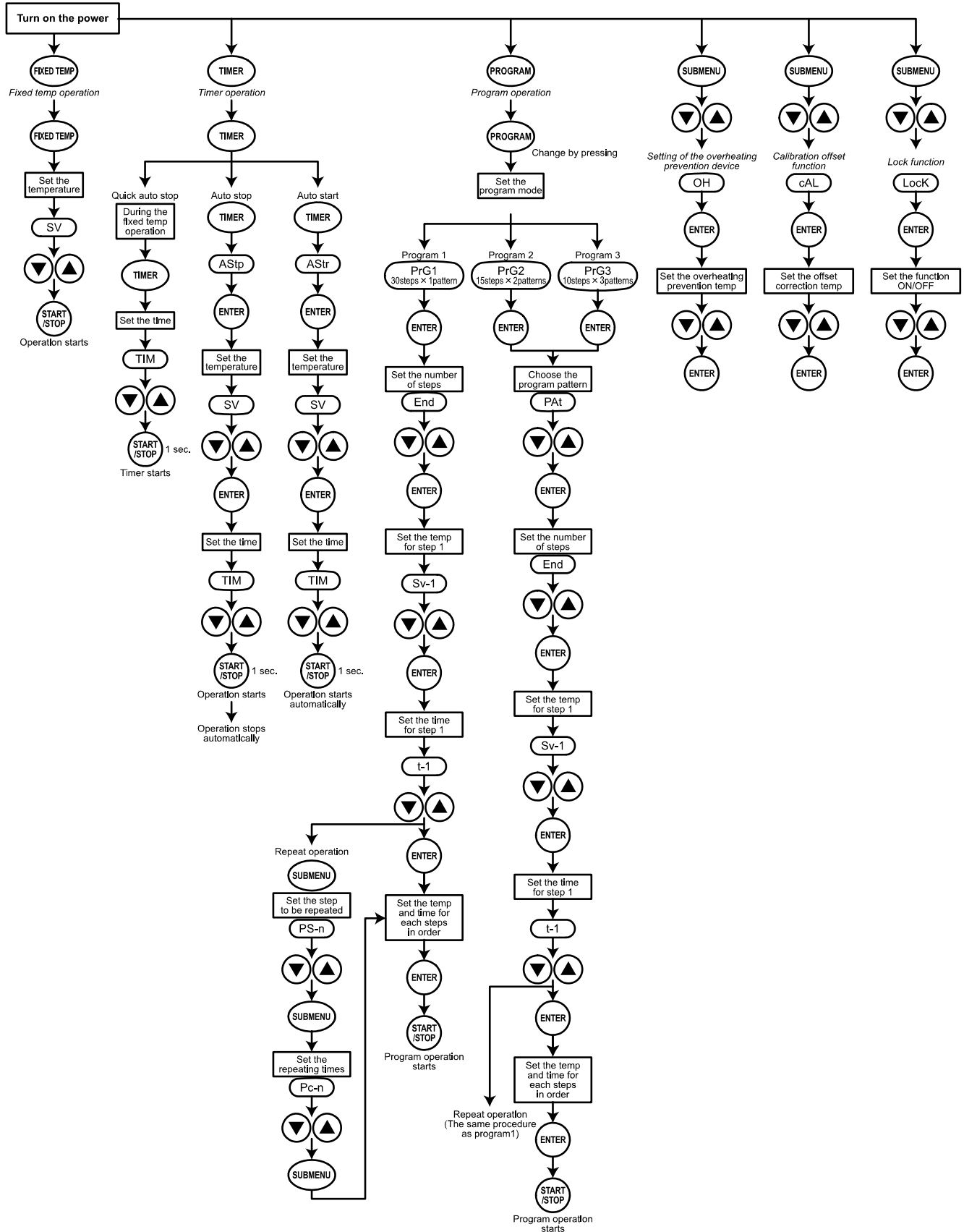

Fixed Temperature Operation

Fixed temperature operation procedure

1. Turn on the power (turn on the breaker in front)

- ❖ The default value is displayed for about four seconds after turning on the power. The screen then displays the initial setting. The current temperature in furnace, operation mode character and setting temperature of overheating prevention device are displayed on respective screens.

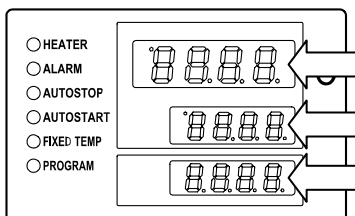

Measurement temperature screen:

Displays the current temperature in furnace.

Setting temperature screen:

Displays the operation mode character. (Refer to Page 13)

Overheating prevention screen:

Displays the setting temperature of overheating prevention device

2. Select the operation mode

- Press the FIXED TEMP key to display "FIX", which indicates the fixed temperature operation, on the center display screen.

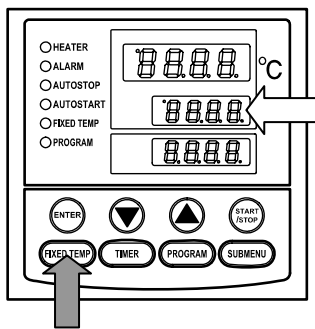

3. Set the temperature

- Press the FIXED TEMP key again.
- The setting temperature screen displays the character "SV" which indicates the temperature setting. Also it displays the current setting temperature with blinking. The FIXED TEMP lamp blinks, too.
- Set the temperature by pressing the "▼▲".

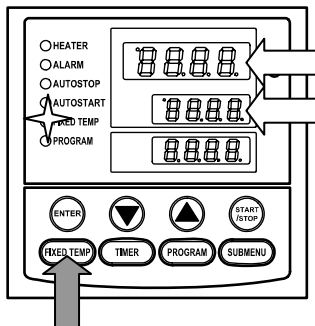

4. Start operation

- Press the orange START/STOP key for about one second. The unit starts operation and the blinking FIXED TEMP lamp lights on.

5. Stop operation

- Press the orange START/STOP key for about one second. The unit stops operation and the FIXED TEMP lamp lights off. The screen returns to the initial setting screen.

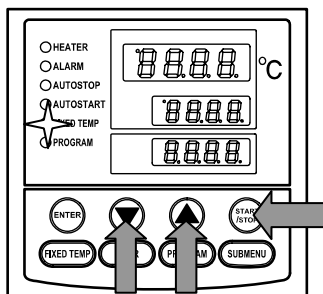

To correct or check setting...

Press the FIXED TEMP key again to correct or check the setting.

Changing the setting temperature during operation is also possible by pressing the FIXED TEMP key.

Quick Auto Stop Operation

Quick auto stop operation procedure

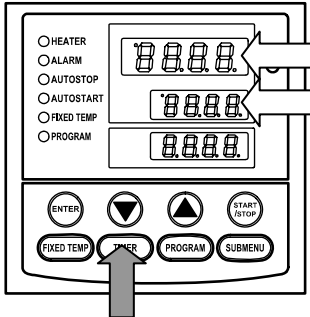

This operation is used to specify the period up to automatic stop, i.e., sets the auto stop timer during operation.

1. Set the time up to stop during fixed temperature operation

- Check that the FIXED TEMP lamp lights on and that the unit is under operation.
- Press the TIMER key.
- The measurement temperature display screen displays the character "tim", which indicates the timer setting. The setting temperature display screen displays the current setting time with blinking.
- Select the time by pressing the "▼▲".

Timer function:

- The maximum setting time is "999 hours and 50 minutes".
- The time can be set in increments of a minute under 99 hours and 59 minutes.
- It can be set in increment of ten minutes over 100 hours.
- The "▼▲" can change the setting time quickly when it is pressed continuously. Press them discontinuously when fine adjustment is needed.

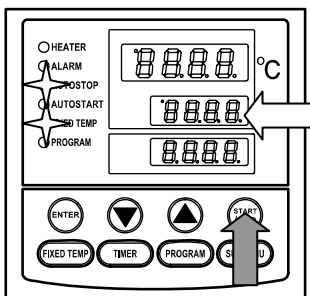

2. Start timer operation

- Press the START/STOP key for one second after deciding the time.
- Timer operation starts with the FIXED TEMP and AUTO STOP lamps lighting on.
- The timer is activated at the point when the START/STOP key is pressed.

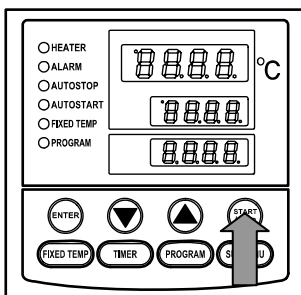

3. Stop/terminate timer operation

- The operation stops automatically at setting time.
- Buzzer continues to sound for about five minutes at operation stop.
- The setting temperature screen displays the character "End", which indicates termination of operation, with the FIXED TEMP and AUTO STOP lamps lighting on. Press the START/STOP key to terminate the timer operation mode. The screen returns to the initial setting screen.

To correct or check setting...

Changing the setting temperature during operation is possible by pressing the FIXED TEMP key. Press the ENTER key after changing the setting.

Changing the setting time during operation is possible by pressing the TIMER key. (Note that the time setting is required using the value calculated by adding a new additional time to the already passed time in this case.) Press the START/STOP key after changing the setting.

Press the ▼ key to display the setting temperature, operation mode and residual time on the setting temperature screen.

Auto Stop Operation

Auto stop operation procedure

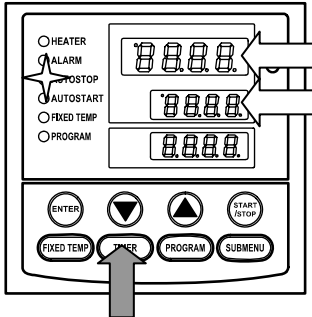

This operation is used to specify the automatic stop time in the fixed temperature operation.

1. Set stop time

- ① Press the TIMER key on the initial screen.
Press the TIMER key again. The setting temperature display screen displays the character "AstP", which indicates the auto stop operation, with blinking.
- ② Press the ENTER key.
The measurement temperature screen displays the character "SV", which indicates the temperature setting. The setting temperature screen displays the current setting temperature with blinking. The AUTO STOP lamp blinks, too.
- ③ Set the temperature using the "▼▲".
- ④ Press the ENTER key again.
The measurement temperature display screen displays the character "tim", which indicates the timer setting. The setting temperature display screen displays the current setting time with blinking.
- ⑤ Set the time using the "▼▲".

Timer function:

- The maximum setting time is "999 hours and 50 minutes".
- The time can be set in increments of a minute under 99 hours and 59 minutes.
- It can be set in increment of ten minutes over 100 hours.
- The "▼▲" can change the setting time quickly when it is pressed continuously. Press them discontinuously when fine adjustment is needed.

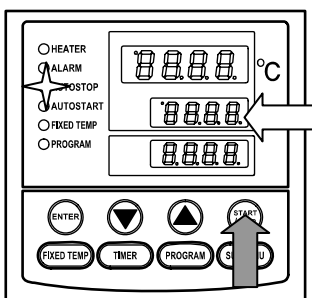

2. Start timer operation

- Press the START/STOP key for one second after deciding the time.
- Timer operation starts with the AUTO STOP lamp lighting on.
- The timer is activated at the point when the temperature in furnace (measurement temperature) reaches to the setting temperature.

Auto Stop Operation

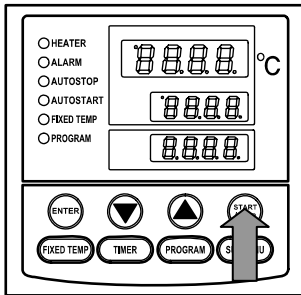

3. Stop/terminate timer operation

- The operation stops automatically at setting time.
- Buzzer continues to sound for about five minutes at operation stop.
- The setting temperature screen displays the character "End", which indicates termination of operation, with the FIXED TEMP and AUTO STOP lamps lighting on. Press the START/STOP key to terminate the timer operation mode. The screen returns to the initial setting screen.

To correct or check setting...

Changing the setting temperature or time during operation is possible by pressing the TIMER key. Use the "▼▲" to change the setting value. Press the ENTER key respectively after changing the setting. (Note that the time setting is required using the value calculated by adding a new additional time to the already passed time in this case.)

Press the "▼" to display the setting temperature, operation mode and residual time on the setting temperature screen.

When the dot is blinked, the indicator of the remaining time e.g."1.30" indicates the countdown. When the dot is lit, the unit is under waiting (that is, the unit is under increasing or decreasing toward setting temperature), and the timer stop s counting.

Auto Start Operation

Auto start operation procedure

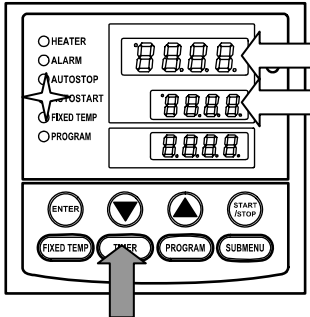

This operation is used to specify the period up to automatic start after power on.

1. Set start time

- ① Press the TIMER key on the initial screen.
Press the TIMER key again. The setting temperature display screen displays the character "Astr", which indicates the auto start operation, with blinking.
- ② Press the ENTER key.
The measurement temperature screen displays the character "SV", which indicates the temperature setting. The setting temperature screen displays the current setting temperature with blinking. The AUTO START lamp blinks, too.
- ③ Set the temperature using the "▼▲".
- ④ Press the ENTER key again.
The measurement temperature display screen displays the character "tim", which indicates the timer setting. The setting temperature display screen displays the current setting time with blinking.
- ⑤ Set the time using the "▼▲".

Timer function:

- The maximum setting time is "999 hours and 50 minutes".
- The time can be set in increments of a minute under 99 hours and 59 minutes.
- It can be set in increment of ten minutes over 100 hours.
- The "▼▲" can change the setting time quickly when it is pressed continuously. Press them discontinuously when fine adjustment is needed.

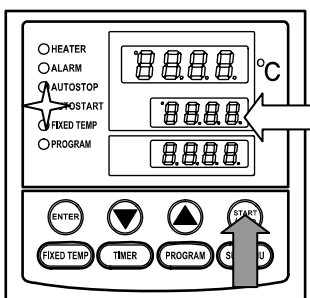

2. Start timer operation

- Press the START/STOP key for one second after deciding the time.
- Timer operation starts with the AUTO START lamp lighting on.

Auto Start Operation

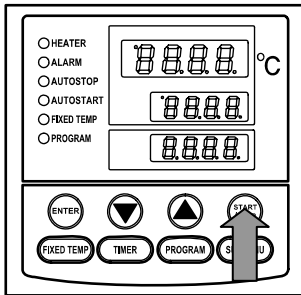

3. Stop/terminate timer operation

- The operation starts automatically at setting time.
- Press the START/STOP key for one second to stop or terminate operation. The screen returns to the initial setting screen.

To correct or check setting...

Changing the setting temperature or time during operation is possible by pressing the TIMER key. Use the "▼▲" to change the setting value. Press the ENTER key respectively after changing the setting. (Note that the time setting is required using the value calculated by adding a new additional time to the already passed time in this case.)

Press the "▼" to display the setting temperature, operation mode and residual time on the setting temperature screen.

Note that the setting condition is impossible to change once starting the operation after passing the auto start operation time. In this case, stop the operation by pressing START/STOP key, and reset to initial status.

Program Operation

This operation is used to change the temperature according to the setting temperature and time.

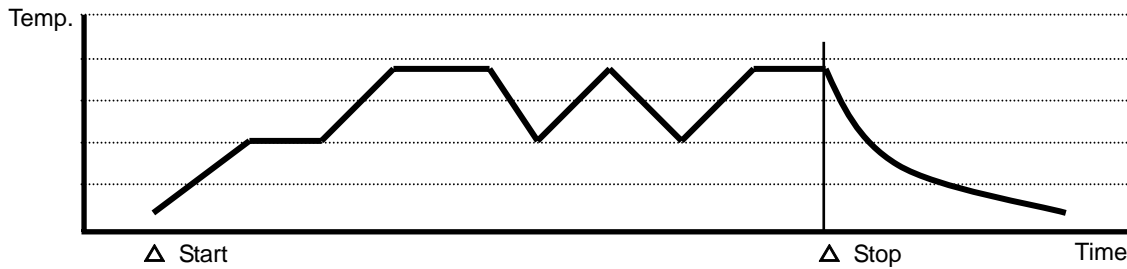

Program types

Six patterns of program types maximum can be input.

PrG1	-	1 program pattern using 30 steps maximum can be created.
PrG2	PA1	2 program patterns using 15 steps maximum can be created.
	PA2	
PrG3	PA1	3 program patterns using 10 steps maximum can be created.
	PA2	
	PA3	

Before inputting program...

Input program patterns before program operation.

- ① Check the number of steps in a created program and their setting temperature/time. Use the program preparation form in pages 26 and 27 to check.
- ② Check the temperature rise/fall capability of the unit. Set the time within the capability above. Suppose, for instance, that in the unit which has capability of increasing or decreasing temperature by 3°C within ten minutes, about 35 minutes is needed to increase or decrease temperature by 10°C from current temperature (Refer to the "Temperature Rise/Fall Curve (Reference)" on the pages 23 to 25.)

Repeat function:

Repeat function is useful in case the operation uses the program repeating the same program steps. Refer to page 22 for the function.

- ③ Check if the controller has sufficient free pattern for the number of steps to be created. The steps, however, using the repeat function mentioned above are not counted.

Program Operation

Program creation

The program pattern below is explained as an example.

1. Program pattern example

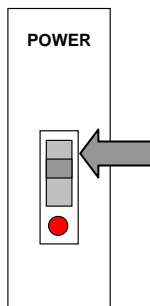
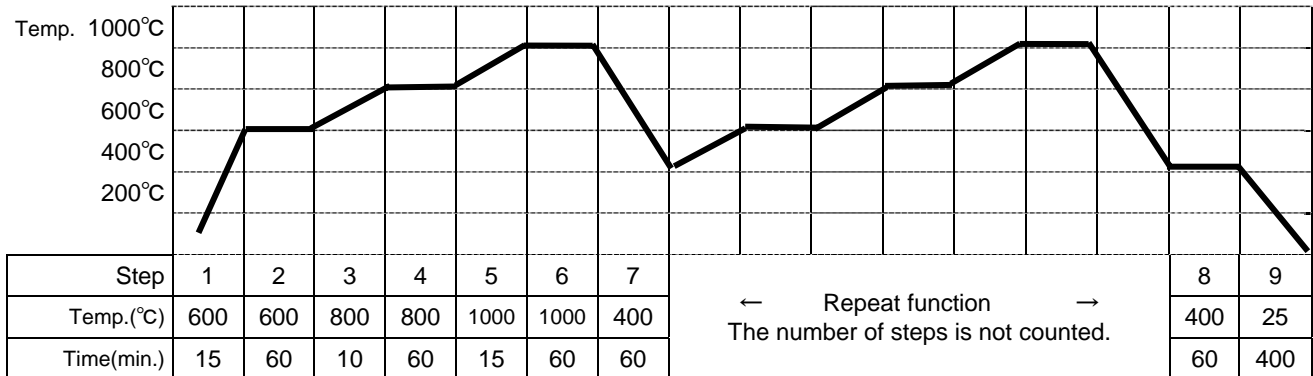

1. Turn on the power

- Turn on the power switch of the unit.
- The display on the controller lights on.
- The initial screen is displayed for about four seconds, then the measurement temperature (temperature in furnace) is displayed.
- ❖ The initial screen displays the software version information, sensor used and setting temperature of overheating prevention device.

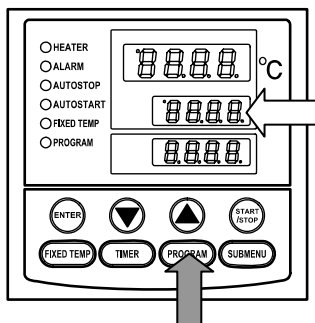

2. Select program mode/program pattern

- ① Press the PROGRAM key once.
The measurement temperature display screen displays the previous program mode.
Press the PROGRAM key again to display the next program mode.
 - ② Select the mode and press the ENTER key.
 - When PrG1 is selected, the measurement temperature display screen displays "End".
 - When PrG2 is selected, the measurement temperature display screen displays the program pattern "PAT1". For the pattern of PrG2, select "1" or "2" using the "▲▼". Press the ENTER key again. The measurement temperature display screen displays "End".
 - When PrG3 is selected, the measurement temperature display screen displays "PAT1". For the pattern of PrG3, select "1", "2" or "3" using the "▲▼". Press the ENTER key again. The measurement temperature display screen displays "End".
- ❖ "End" is the character for indicating the number of the steps to be applied. It needs to set the number of the steps at the beginning of creating program.
Any of PrG1, PrG2 or PrG3 can be selectable in the program example above, where nine steps maximum are used.

Program Operation

The example shown below explains the method of program registration using PrG3.

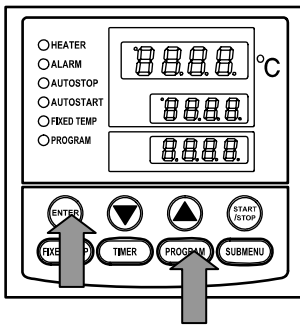

4. Register program

- ① Select PrG3 referring to 3 mentioned above.
- ② Input the number of steps, temperature and time for respective steps using the program creation sheet.
- ③ Press the ENTER key. The PA t 1 is displayed with blinking. ("End" is displayed if PrG1 is selected. In this case, go to ⑥)
- ④ Select the unused pattern from among Pat1, Pat2 and Pat3 using the "▲▼".
- ⑤ Press the ENTER key. "End" is displayed and the step number "10" is also displayed with blinking.
 - ❖ "End" is a character which indicates the total step number to be used. "9" will be input here.
- ⑥ INPUT "9", which is the total step number to be used here, using the "▲▼".
- ⑦ Press the ENTER key. The character "SV-1", which indicates the setting temperature of the first step, is displayed. The current setting temperature is also displayed with blinking.
- ⑧ Set the temperature of the first step using the "▲▼". "600" is input here to set the temperature to 600°C.
- ⑨ Press the ENTER key. The character "t-1", which indicates the setting time of the first step, is displayed. The current setting time is also displayed with blinking.
 - ❖ Before setting the time, check the temperature rise/fall capability of unit.
 - ❖ For example, about 10 minutes is needed to increase the temperature from room temperature to 600°C for FO410 type (15 minutes for FO810 type). In the example, it takes about 2 minutes to increase the temperature by 100°C, accordingly takes about 15 minute until it reaches to 600°C. Add an extra considering the temperature stability time.
 - ❖ The setting time of timer in respective steps is 999 hours and 50 minutes maximum.
- ⑩ After the time is set, press the ENTER key.
- ⑪ The character "SV-2", which indicates the setting temperature of the second step, is displayed. In the same way, input the temperature and time for respective steps using the program creation sheet.

The different method is necessary where program repeat function is used. In this case, press the SUBMENU key after setting the time (t-7 in the example) in the step where the repeat operation is to be used (Step 7 in the example). This enters to the repeat function setting mode.

 - ❖ Follow the "Use program repeat function" in page 28 for the input method of program repeating function.
- ⑫ The screen returns to the initial setting screen after the setting of temperature and time in the final step is completed.

Verification run:

Make sure to check the setting temperature and time by operating the unit without load before performing actual run with samples.

Program Operation

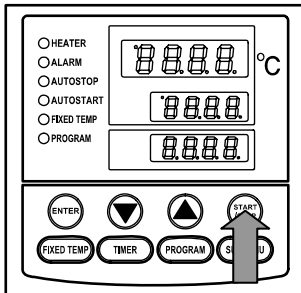

5. Start program operation

- Press the START/STOP key for about one second. The program operation previously set starts.
- The PROGRAM lamp lights on and the setting temperature screen displays the step currently under operation.
- ❖ Press the "▼" to check the setting temperature and residual time of step currently under operation on the setting temperature screen.

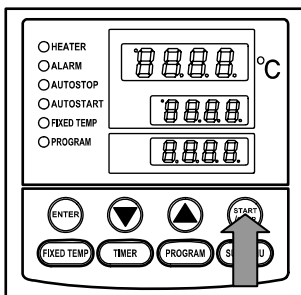

6. End program operation

- Buzzer continues to sound for about five minutes at operation stop.
- The measurement temperature screen displays the character "END", which indicates the termination of program.
- Press the START/STOP key to return to the initial screen.

Timer function:

- The maximum setting time is "999 hours and 50 minutes".
- The time can be set in increments of a minute under 99 hours and 59 minutes.
- It can be set in increment of ten minutes over 100 hours.
- The "▼▲" can change the setting time quickly when it is pressed continuously. Press them discontinuously when fine adjustment is needed.

To correct or check setting...

Press the FIXED TEMP key to correct the created program or to check the setting value. The screen returns to the former one, where correction or check is possible.

Last screen is displayed when the FIXED TEMP key is once pressed.

Note: Correction or check should be made on the program setting screen.

Wait operation in program operation

The succeeding step does not start in case the measurement temperature does not reach to, or exceeds the setting temperature when a program goes to the next step in program operation. This unit, however, is previously set to carry out the next step if the measurement temperature is within $\pm 5^{\circ}\text{C}$ of the setting temperature.

Program Operation

Use program repeat function

This section explains how to register the program repeat (repeating a program pattern) in program operation.

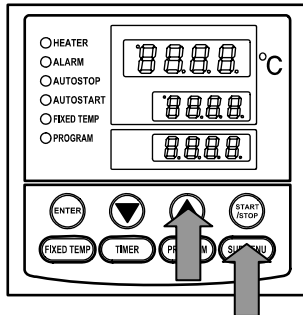

This section explains the registration procedure of program using repeat function in "4. Register program" above.

The procedure sets the step number to be repeated "PS-n" and repeating times "Pc-n"(n: step number)

- ① Press the SUBMENU key in stead of the ENTER key after setting the time (t-7 in the example) in the step where the repeat operation is to be used (Step 7 in the example). This enters to the repeat function setting mode.
- ② The measurement temperature screen displays the character "PS-n", which indicates the step to be repeated in the program pattern. The measurement temperature screen indicates "PS-7" in the example because repeat function is used at the seventh step. The step number 1 to 7 can be input in the setting temperature display screen. Enter the number (1 in the example) using the "▲▼".
- ③ Press the SUBMENU key.
The measurement temperature screen displays the character "Pc-n", which indicates the repeating times. Enter the value of repeating times (2 in the example) with the "▲▼".
- ④ The screen goes to that for the next step when the SUBMENU key is pressed again.
The screen to input the Sv-8 is displayed next in the example.

To correct or check setting...

Correction of setting during the repeat setting mode is impossible.

To correct or check the setting, end the setting of step currently input. Press the FIXED TEMP key after the temperature setting screen for the next step appears. The screen returns to the former one and re-setting is possible.

Note: Correction or check should be made on the program setting screen.

Temperature Rise/Fall Curve (Reference)



The following graph shows the data for temperature rise/fall of respective device types. The data shown is only reference because these values vary depending on the quantity of sample or an ambient temperature.

Use the data for temperature rise/fall when programming.

Temperature rising characteristics in FO100

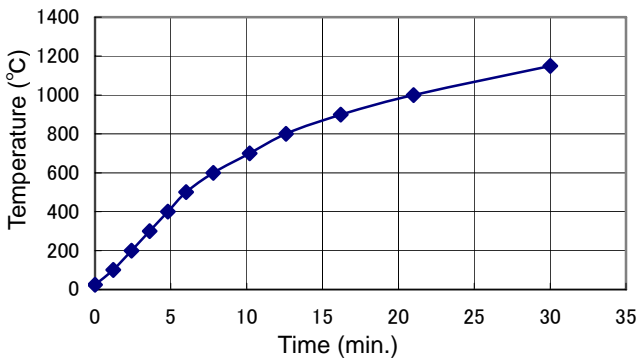

Temperature falling characteristics in FO100

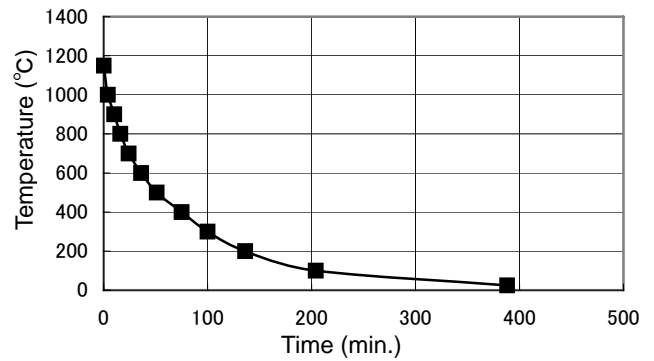

Temperature rising characteristics in FO200

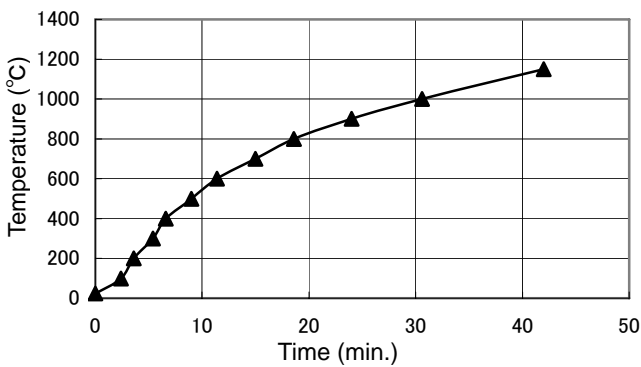

Temperature falling characteristics in FO200

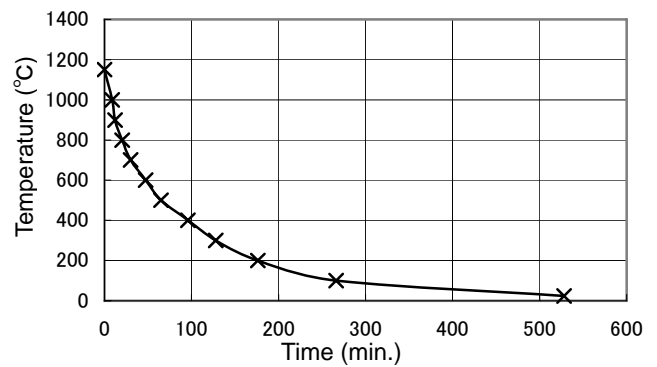

Temperature rising characteristics in FO300

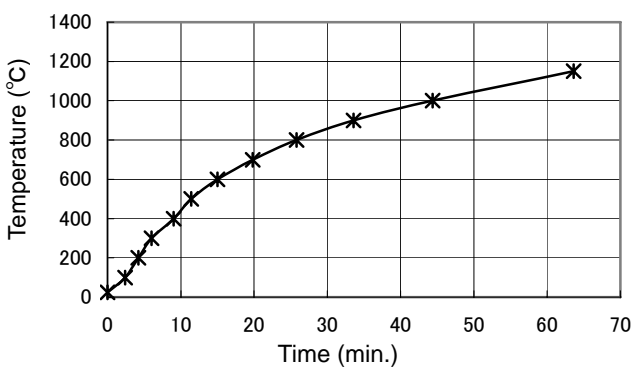

Temperature falling characteristics in FO300

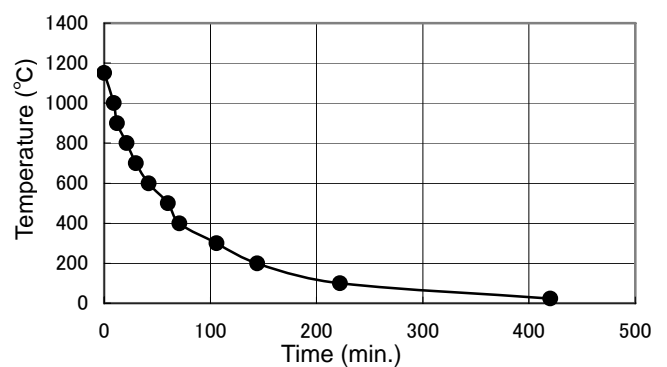

Temperature Rise/Fall Curve (Reference)

Temperature rising characteristics in FO310

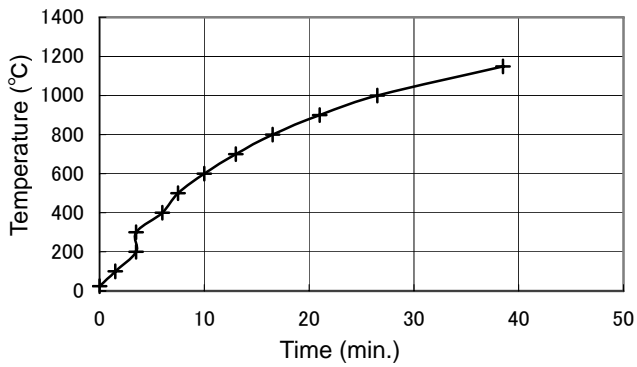

Temperature falling characteristics in FO310

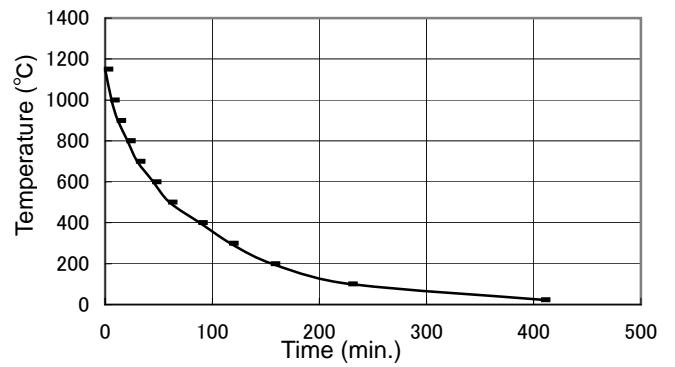

Temperature rising characteristics in FO410

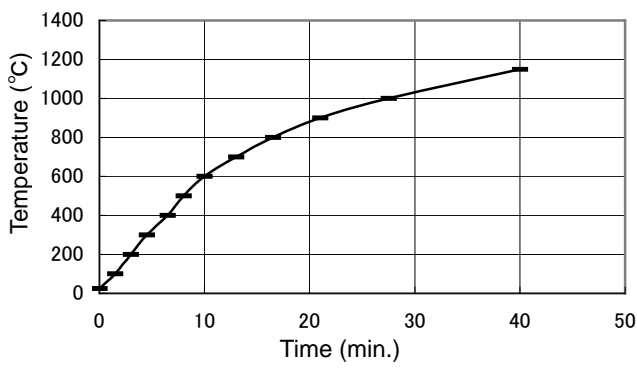

Temperature falling characteristics in FO410

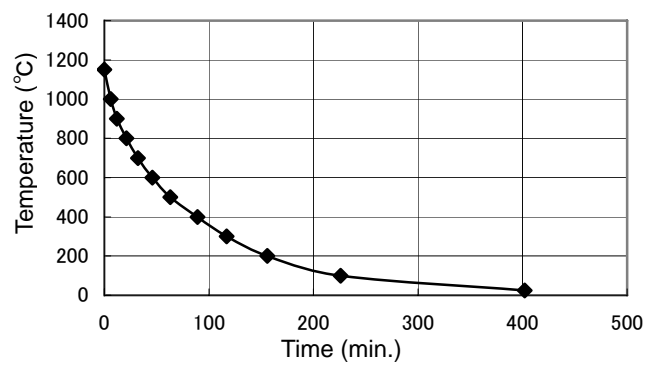

Temperature rising characteristics in FO510

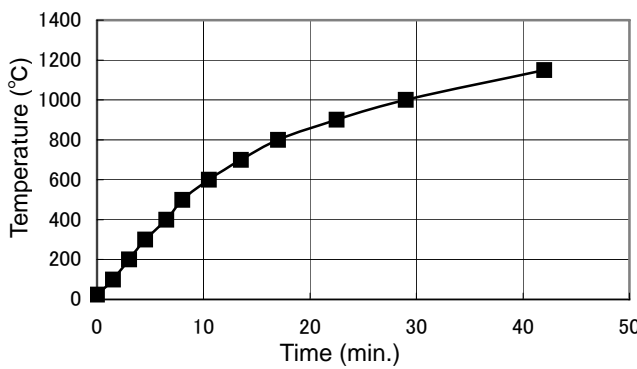

Temperature falling characteristics in FO510

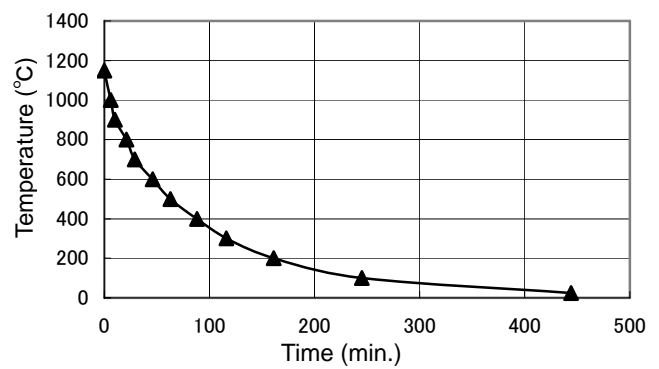

Temperature Rise/Fall Curve (Reference)

Temperature rising characteristics in FO610

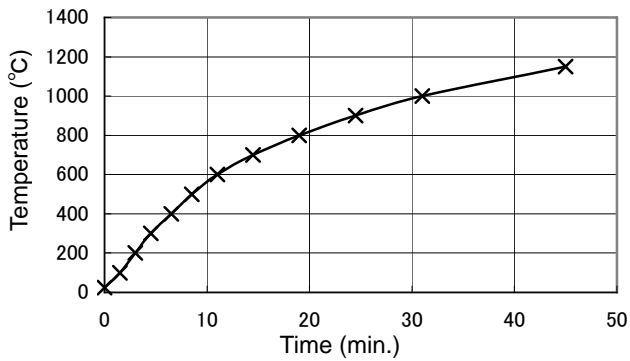

Temperature falling characteristics in FO610

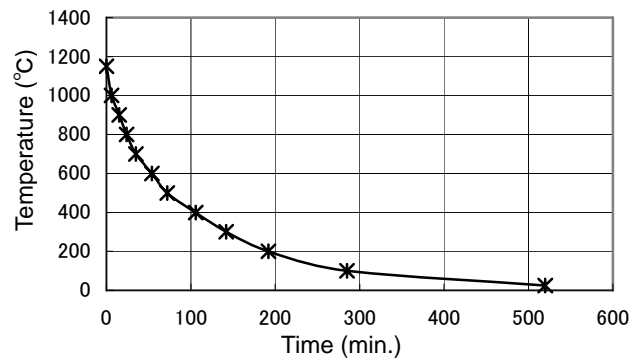

Temperature rising characteristics in FO710

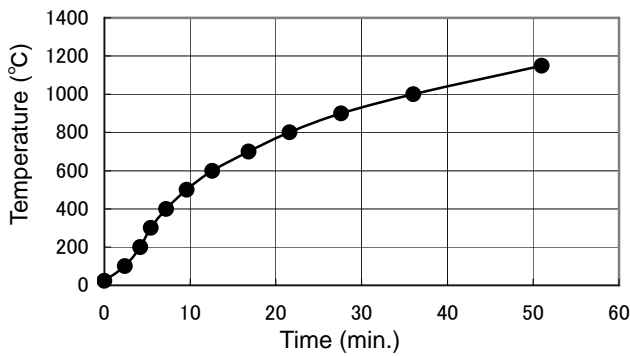

Temperature falling characteristics in FO710

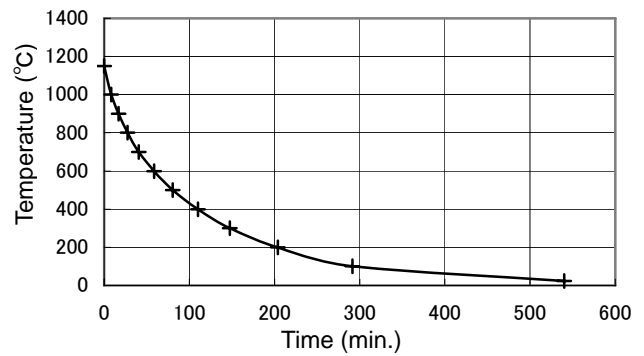

Temperature rising characteristics in FO810

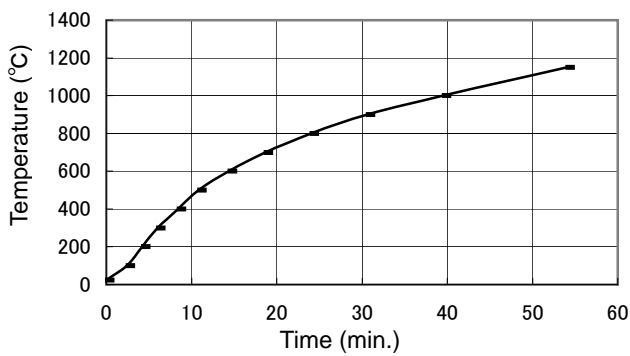

Temperature falling characteristics in FO810

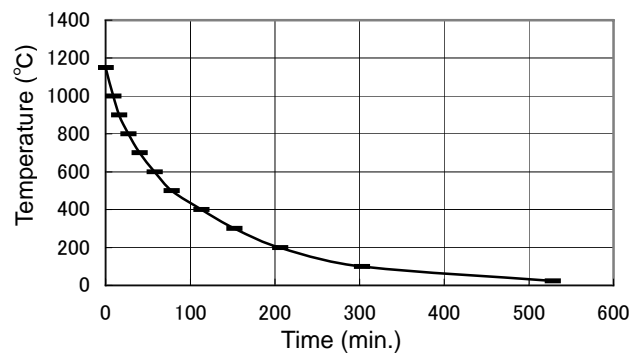

Program Operation

Programming Preparation Form 1

(Please use this form by making copies)

Register with:	PrG1 PrG2 PrG3	PA1 PA2 PA3	No.	
Project Name				Date
				Programmer

Program Pattern

1150°C	
1000°C	
900°C	
800°C	
700°C	
600°C	
500°C	
400°C	
300°C	
200°C	
100°C	
STEP No.	

Program Operation

Programming Preparation Form 2

(Please use this form by making copies)

Register with:	PrG1 PrG2 PrG3	PA1 PA2 PA3	No.	
Project Name				Date
				Programmer

Input Value

	Temperature (°C)	Time (min.)	Repeat Function
Step 1		:	To/Times
Step 2		:	/
Step 3		:	/
Step 4		:	/
Step 5		:	/
Step 6		:	/
Step 7		:	/
Step 8		:	/
Step 9		:	/
Step 10		:	/
Step 11		:	/
Step 12		:	/
Step 13		:	/
Step 14		:	/
Step 15		:	/
Step 16		:	/
Step 17		:	/
Step 18		:	/
Step 19		:	/
Step 20		:	/
Step 21		:	/
Step 22		:	/
Step 23		:	/
Step 24		:	/
Step 25		:	/
Step 26		:	/
Step 27		:	/
Step 28		:	/
Step 29		:	/
Step 30		:	/

Other Functions

Setting of Overheating Prevention Device

The unit has the overheating prevention device (manual reset) that consists of independent temperature measurement circuit, CPU, sensor and output circuit (it shares power source, display, and key input with the controller) in addition to the automatic overheating prevention function (auto reset) in the controller.

Setting range/function

The unit has failsafe functions against overheating. One of them is built in the controller and previously set at factory shipment so to be automatically activated when the temperature exceeds the setting temperature of temperature controller by 12°C, where the heater repeats on and off.

The other is united with the controller, which can be set by operating the keys on the controller.

The setting range of latter is from 0°C to 1300°C.

In case the temperature in furnace exceeds the setting temperature of controller to reach to that of overheating prevention device, the circuit is shut off and "Er19" is displayed with blinking on the screen of controller with buzzer sound.

If the device is once activated, "Er19" continues to be displayed until the power is newly turned on.

Temperature setting procedure

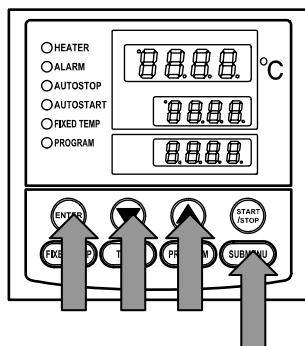

1. Turn on the power (turn on the breaker in front)

- The default value is displayed for about four seconds after turning on the power. The screen then displays the initial setting. The current temperature in furnace, operation mode character and setting temperature of overheating prevention device are displayed on respective screens.

2. Set the temperature for overheating prevention

- Press the SUBMENU key.
- Press the "▼▲" several times to select the setting character of overheating prevention temperature "OH".
- Press the ENTER key. The current setting temperature is displayed with blinking on the setting temperature screen.

Note: To prevent improper operation, set the value 100°C or more over the setting temperature of controller.

- Select the value using the "▼▲" and then press the ENTER key. This completes the setting.

Notes:



- The standard setting temperature of device is "the maximum setting temperature of unit plus 100°C" or "setting temperature plus 100°C". If the unit performs improper operation, increase it 50°C more.
- The setting range of overheating prevention device is from 0°C to 1300°C. Improper setting of temperature may cause inoperative of unit, malfunction of device, e.g. it is activated during increasing in temperature in furnace, or unexpected accidents such as fire disaster. To prevent such matters, set a proper value. **The temperature is set to 1200°C at factory shipment. Do not set the value larger than it.**
- In some case, the overheating prevention device is possible to be activated by mistake when its yield temperature is set to around room temperature.
- The purpose of overheating prevention device is to protect the unit from overheating. It does not intend to protect the samples, or to protect them from the accident caused by the use of explosive or inflammability.

Other Functions

Use calibration offset function

Calibration offset is a function which corrects the difference between the temperature in furnace and that of controller (sensor temperature) if arises. The function parallel corrects the difference either to the plus or minus side within the whole temperature range of unit. The function can be set or cancelled by the SUBMENU key.

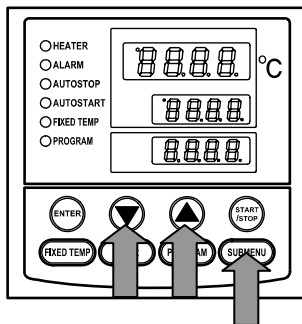
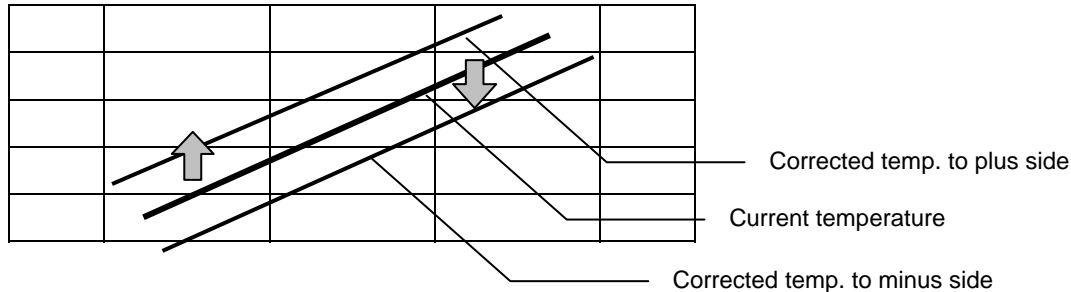

- ① Start operation with the target setting temperature. Check the temperature in furnace (temperature of sample) with a thermograph after it is stabilized.
- ② Check the difference between the setting temperature and that in furnace (temperature of sample).
- ③ Press the SUBMENU key. Select the character "cAL", which indicates the calibration offset, using the "▲▼", and then press the ENTER key.
- ④ Input the difference using the "▲▼" and then press the ENTER key. This completes the setting.

- ❖ The setting range of offset correction temperature is +99°C to plus side and -99°C to minus side respectively.

When it is set to the minus side, the temperature on the measurement temperature display screen falls by the setting temperature, while the temperature on furnace rises.

When it is set to the plus side, the temperature on the measurement temperature display screen rises by the setting temperature, while the temperature on furnace falls.

- ❖ The unit has two-point correction function, which performs offset between low-temperature zone and high-temperature zone. Please consult our local branch office when carrying out validation of temperature controller.

Use lock function

This function locks the operation status previously set. The function can be set or cancelled by the SUBMENU key.

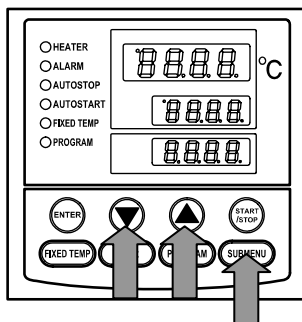

- ① Press the SUBMENU key. Select the character "Lock", which indicates the lock of setting value, using the "▲▼", and then press the ENTER key.
- ② The setting temperature screen displays "oFF". The setting value is locked when it is turned to "o n " using the "▲".
- ③ Press the SUBMENU key again to cancel the lock. Select the character "Lock", which indicates the lock of setting value, using the "▲▼", and then press the ENTER key. Select "oFF" with the "▼" and then press the ENTER key to cancel the function.

- ❖ All keys other than the START/STOP and SUBMENU keys are lock when the lock function is on.

WARNING!

If a problem occurs

-  If smoke or strange odor should come out of this unit for some reason, turn off the power key right away, and then turn off the circuit breaker and the main power. Immediately contact a service technician for inspection. If this procedure is not followed, fire or electrical shock may result. Never perform repair work yourself, since it is dangerous and not recommended.

Substances that cannot be used

-  Never use explosive substances, flammable substances and substances that include explosive or flammable ingredients in this unit. Explosion or fire may occur. (Refer to page45 "List of Dangerous Substances".)

CAUTION!

Do not step on this unit

-  Do not step on this unit. It will cause injury if this unit fall down or break.

Do not put anything on this unit

-  Do not put anything on this unit. It will cause injury if fall.

Prevention of burn

-  After an operation, the oven unit and the inside of door, samples have a high temperature for a while. For prevent a burn, be careful that do not touch to the parts in the above when handling samples.

During a thunder storm

-  During a thunderstorm, turn off the power key immediately, then turn off the circuit breaker and the main power. If this procedure is not followed, fire or electrical shock may be caused.

About the amount of samples

-  If the excessive amount of sample is set, it could be impossible to control the temperature normally. To keep the temperature control accuracy, do not use this unit in overload.

Return after power failure

-  When power is supplied after a power failure, the device automatically starts operation again with the same state as just before the power failure. It is danger that the device starts unattached operation after a power failure. We recommend for you to turn off the switch of this unit if a power failure occurs during operation.

In-oven temperature

-  This unit uses a cooling fan to prevent an over temperature of its outer surface during operation when the earth leakage breaker is turned ON. Do not turn OFF the interrupter, or do not disconnect the power supply plug directly when the in-oven temperature is 600°C or more after operation, except in the case of emergency.

Provide ventilation at the first operation

-  This unit exhausts smoke and smell due to burning of organic matters in the furnace when it is used for the first time. This is not abnormal, but ventilating inside the room should be done.

Furnace may be cracked



Though the furnace may be cracked when it is used with high temperature, this does not affect the use or performance of this unit.

Open/close door in high temperature affects the device



Do not open/close the door as possible at the in-oven temperature of 500°C or more, which affects the lives of sensor, oven and heater. Quickly open/close it after operation if necessary.

Do not leave door open for a long time at high temperature



Leaving the door open for long time at high temperature may cause a radiation heat, which could result in breakdown on the operation panel or controller.

Fine powder may fly



This unit uses an iron chrome heater. Fine powder from its protective film (oxide film) is possible to be flown during operation. Protect the sample with a cover if needed.

Make protective film on heater



The heater used on this unit forms a protective film on its surface under high temperature. Make the film by operating this unit for ten hours at the temperature of 1050°C when using it under the temperature of 700°C or less.

Heater corrosion



The heater used on this unit can be corroded with halogen elements such as chlorine, fluorinate or alkali metals such as sodium or potassium. Do not contact these materials to the heater.

Sensor deterioration



The sensor on this unit (R thermocouple) is very sensitive. Do not contact it to samples when loading or unloading them. Do not touch the sensor with bare hands, which may cause the degradation.

Sensor corrosion



The sensor used on this unit can be corroded at high temperature with reducing substances such as alkali metal, metal steam, metal oxide, carbon monoxide, carbon, phosphorus, selenium or arsenicum or other reducing ambiances. Do not use these materials.

When using N2 gas...



Under the Atmosphere of N2 gas, high temperature nitrifies the surface of heater, which prevents the formation of protective film on it. Upper limit temperature for use is, therefore, lower than that under atmospheric air. Use the temperature within the range of 100 to 900°C when operating this unit under N2 gas.

Notes for overheating prevention device



In case there is a small difference between the set values of temperature for overheating prevention device and that of controller, the overheating prevention device may be activated with displaying **Er.07** when the temperature reaches to the set value of controller. Set the temperature of overheating prevention device so it be at least 100°C or more higher than that of controller. (When the setting temperature is lower, there is a case that overshoot occurs because this unit is high temperature type furnace. This overheating prevention device should be used for protect the unit.) The default value of the overheating prevention device at factory shipment is 1200°C.

Exhaust device unit



Connect the ground lead to the exhaust device unit with the main body chassis when it installed.

Daily Inspection and Maintenance

For the safety use of this unit, please perform the daily inspection and maintenance without fail. Using the city water to this unit might attach dirt. Do inspect and maintain this point while performing daily inspection and maintenance.

WARNING!

- Disconnect the power cable from the power source when doing an inspection or maintenance unless needed.
- Perform the daily inspection and maintenance after returning the temperature of this unit to the normal one.
- Do not disassemble this unit.

CAUTION!

- Use a well-drained soft cloth to wipe dirt on this unit. Do not use benzene, thinner or cleanser for wiping. Do not scrub this unit. Deformation, deterioration or color change may result in.

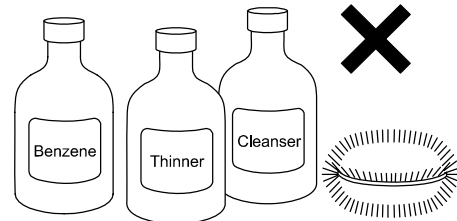

Monthly maintenance

- Check the earth leakage breaker function.
 1. Connect the power cord.
 2. Turn the breaker on.
 3. Push the red test switch by a ballpoint pen etc.
 4. If there is no problem, the earth leakage breaker will be turned off.

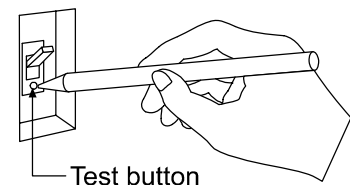

- Check the movement of overheating prevention device.

Perform the operation under the specified value of device with certain preset temperature. Then set the operation temperature of overheating prevention device to the value approximately 10°C lower than the preset temperature of device.

In normal condition, the overheating prevention device shuts off the heating circuit in a few seconds, at the same time the alarm lamp lights on and the Er19 is indicated accompanied with a warning buzzer.

- ❖ Be sure to check the movement of earth leakage breaker malfunction and overheating prevention device mentioned above before a long-term continuous operation or unmanned night operation.

For any questions, contact the dealer who you purchased this unit from, or the nearest sales division in our company.

When not using this unit for long term / When disposing

CAUTION!

When not using this unit for long term...

- Turn off the power and disconnect the power cord.

WARNING!

When disposing...

- Keep out of reach of children.
- Remove the door and driving parts.
- Treat as large trash.

Environmental protection should be considered

We request you to disassemble this unit as possible and recycle the reusable parts considering to the environmental protection. The feature components of this unit and materials used are listed below.

Component Name	Material
Main body	
Body	Steel, Melamine, Epoxy composite resin coating, Stainless steel, SUS304
Furnace and Door	Ceramic fiber
Plates	Polyethylene (PET) resin film
Electrical Parts	
Switch, Relays	Resin, Copper, and other composites
Operation panel	Alkyl benzene sulfide (ABS)
Board	Glass fiber and other composites
Heater	Iron chrome wire
Power code	Synthetic rubber coating, Copper, Nickel
Wiring	Glass fiber, Flame resistance plastic, Copper, Nickel
Seals	Resin material
Sensor (R thermocouple)	Platinum element

Safety Device and Error Code

This unit has an automatic diagnosis function built in the controller and safety devices independent of the controller. The table below shows the cause and the solution method when the safety device operates.

Error Code:

When an abnormal condition occurs, an error code appears and the alarm lamp lights in the controller, the buzzer sounds simultaneously. Record the error code and turn off the power of device immediately.

Safety Device	Notify	Cause/Solution
Sensor trouble detection	“ALARM” lamp lights on, “Er.01” appears	<ul style="list-style-type: none"> • Temperature sensor is broken or disconnected. • Make a call for service.
SSR short-circuit detection	“ALARM” lamp lights on, “Er.02” appears	<ul style="list-style-type: none"> • Triac is in short-circuit • Make a call for service.
Heater disconnecting detection	“ALARM” lamp lights on, “Er.03” appears	<ul style="list-style-type: none"> • Heater is disconnected. • Make a call for service.
Memory error	“ALARM” lamp lights on, “Er.15” appears	<ul style="list-style-type: none"> • Failure in internal memory. • Make a call for service.
Internal communication error	“ALARM” lamp lights on, “Er.17” appears	<ul style="list-style-type: none"> • Failure in internal communication or temperature inputting circuit. • Make a call for service.
Overheating	“ALARM” lamp lights on, “Er.19” appears	<ul style="list-style-type: none"> • Overheating prevention device is in operation. • Reset the power supply, and then adjust the setting temperature of the overheating protection device. • If the state does not recover, make a call for service.
Measurement temperature error	“ALARM” lamp lights on, “----” appears	<ul style="list-style-type: none"> • Measurement value is out of display range. • Make a call for service.

Trouble Shooting

Problem	Possible Cause	Solution
The device does not start when turning on the power switch.	Bad condition of earth leakage breaker	Replace the part
	Bad condition of power switch	
	Problem in power source	Use an appropriate power supply.
Temperature does not rise.	Heater is disconnected	Replace the part
	Thermal fuse is disconnected	
	Bad condition of thermoregulator	
Takes too much time to raise temperature.	Bad condition of temperature sensor	Replace the part
	Heater is disconnected	
	Bad condition of thermoregulator	
	Problem in power source	Use an appropriate power supply.
Heater is not turned off after reaching to preset value.	Bad condition of SSR	Replace the part
	Bad condition of thermoregulator	
Thermal fuse blows out.	Bad condition of fan	Replace the part
	Bad condition of thermoregulator	

When power failure occurs...

- When power is supplied after a power failure, the device automatically starts operation again with the same state as just before the power failure. It is danger that the device starts unattached operation after a power failure.
- We recommend for you to turn off the switch of device if a power failure occurs during operation.

In the case if the error other than listed above occurred, turn off the power switch and primary power source immediately. Contact the shop of your purchase or nearest Yamato Scientific Service Office.

In Case of Request for Repair

If the failure occurs, stop the operation, turn OFF the power switch, and unplug the power plug. Please contact the sales agency that this unit was purchased, or the Yamato Scientific's sales office.

< Check following items before contact >

- ◆ Model Name of Product
 - ◆ Production Number
 - ◆ Purchase Date
 - ◆ About Trouble (in detail as possible)
- } See the production plate attached to this unit.

Minimum Retention Period of Performance Parts for Repair

The minimum retention period of performance parts for repair of this unit is 7 years after discontinuance of this unit.

The "performance part for repair" is the part that is required to maintain this unit.

FO100/200/300/310/410

	FO100	FO200	FO300	FO310	FO410
Operating temperature range	100 to 1150°C				
Temperature adjustment accuracy	±2°C (@1150°C)				
Time required to reach highest temperature @LT:1150°C(@RT:850°C)	Approx. 60min.(40min.)	Approx. 60min.(40min.)	Approx. 70min.(50min.)	Approx. 70min.(50min.)	Approx. 70min.(50min.)
Temperature control system	PID control by VS4 controller				
Sensor	R thermocouple (W sensor)				
Temperature setting system	Digital setting				
Temperature display system	Digital display				
Functions for Operation	<ul style="list-style-type: none"> ▪ Fixed temperature operation ▪ Timer operation (Auto stop, Auto start) ▪ Program operation (Max 6patterns: 30steps × 1pattern, 15steps × 2patterns or 10steps × 3patterns) 				
Additional function	Lock function, Auto recovering after power failure, Calibration offset				
Safety device	Earth leakage/circuit breaker, Thermal fuse, Overheating prevention device, Self-diagnostic functions (Sensor error, Memory error, Heater disconnection, SSR short circuit)				
Heater	Iron chrome wire (Cantal AF)				
	1.0KW	1.5KW	2.0KW	2.0KW	2.2KW
Cooling fan	Axial fan motor				
Furnace unit	Ceramic fiber				
Operating ambient temperature range	5 to 35°C				
Internal dimensions (W × D × H mm)	100 × 150 × 100	100 × 250 × 150	200 × 250 × 150	200 × 250 × 150	200 × 300 × 150
External dimensions (W × D × H mm)	346 × 405 × 516	346 × 405 × 516	446 × 505 × 566	446 × 505 × 566	446 × 555 × 566
Internal capacity	Approx. 1.5L	Approx. 3.75L	Approx. 7.5L	Approx. 7.5L	Approx. 9L
Power supply (50/60Hz)	100V AC			200V AC single phase	
	11A	16A	21A	11A	12A
Power cord	3 wires with plug	3 wires with rounded terminal			
Weight	Approx. 24Kg	Approx. 30Kg	Approx. 37Kg	Approx. 37Kg	Approx. 38Kg
Attached accessories	Fuse	× 1	× 1	× 1	× 1
	Other	Instruction manual			

- ❖ The value for performance is under the ambient temperature of 23°C±5°C, the humidity of 65%RH±20%, and without load.
- ❖ The projection is not included for external dimensions.

FO510/610/710/810

	FO510	FO610	FO710	FO8100
Operating temperature range	100 to 1150°C			
Temperature adjustment accuracy	±2°C (@1150°C)			
Time required to reach highest temperature @LT:1150°C(@RT:850°C)	Approx. 80min.(60min.)	Approx. 80min.(65min.)	Approx. 80min.(55min.)	Approx. 80min.(60min.)
Temperature control system	PID control by VS4 controller			
Sensor	R thermocouple (W sensor)			
Temperature setting system	Digital setting			
Temperature display system	Digital display			
Functions for Operation	<ul style="list-style-type: none"> • Fixed temperature operation • Timer operation (Auto stop, Auto start) • Program operation (Max 6patterns: 30steps × 1pattern, 15steps × 2patterns or 10steps × 3patterns) 			
Additional function	Lock function, Auto recovering after power failure, Calibration offset			
Safety device	Earth leakage/circuit breaker, Thermal fuse, Overheating prevention device, Self-diagnostic functions (Sensor error, Memory error, Heater disconnection, SSR short circuit)			
Heater	Iron chrome wire (Cantal AF)			
	2.2KW	2.5KW	3.0KW	4.0KW
Cooling fan	Axial fan motor			
Furnace unit	Ceramic fiber			
Operating ambient temperature range	5 to 35°C			
Internal dimensions (W × D × H mm)	300 × 250 × 150	250 × 350 × 200	270 × 350 × 250	300 × 400 × 250
External dimensions (W × D × H mm)	506 × 505 × 626	506 × 605 × 676	506 × 605 × 726	506 × 655 × 726
Internal capacity	Approx. 11.3L	Approx. 17.5L	Approx. 23.6L	Approx. 30L
Power supply (50/60Hz)	200V AC single phase			
	13.5A	16A	18.5A	21A
Power cord	3 wires with rounded terminal			
Weight	Approx. 44Kg	Approx. 52Kg	Approx. 58Kg	Approx. 62Kg
Attached accessories	Fuse	× 1	× 1	× 1
	Other	Instruction manual		

- ❖ The value for performance is under the ambient temperature of 23°C±5°C, the humidity of 65%RH±20%, and without load.
- ❖ The projection is not included for external dimensions.

Optional Accessories

Name	Product Code	Applied for
Exhaust system unit 100V	214096	FO100/200/300/310
Exhaust system unit 200V	214097	FO310/410/510/610/710/810
Time-up output terminal (*)	200000	All models
Alarm output terminal (*)	200000	All models
Output terminal for measured temperature transmission (4-20mA)	200000	All models
Communication adapter (RS485/RS232C conversion)	200000	All models
N2 gas leading device	200000	All models
Sample tray	200000	All models
Exhaust opening	200000	All models

❖ Either output terminal of the time-up or alarm is available to attach to this unit.

FO100

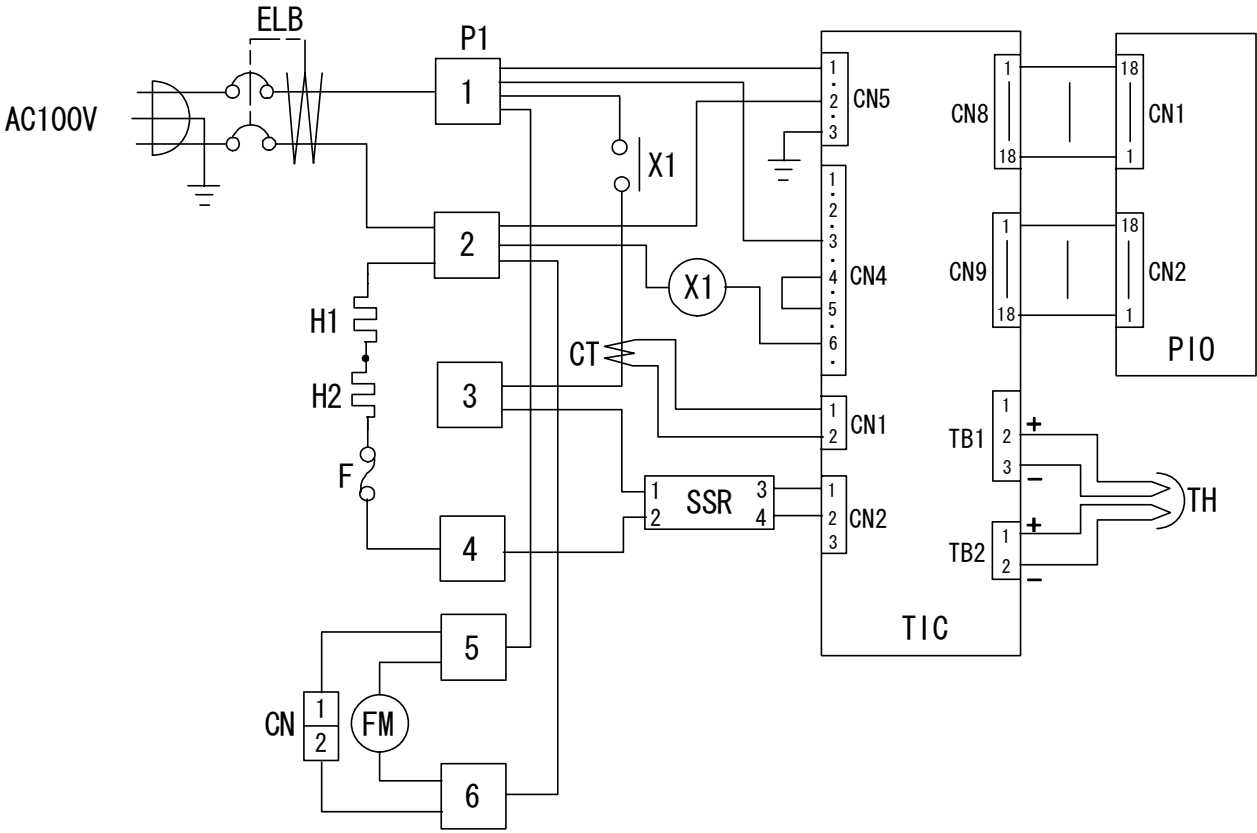

FO200/300

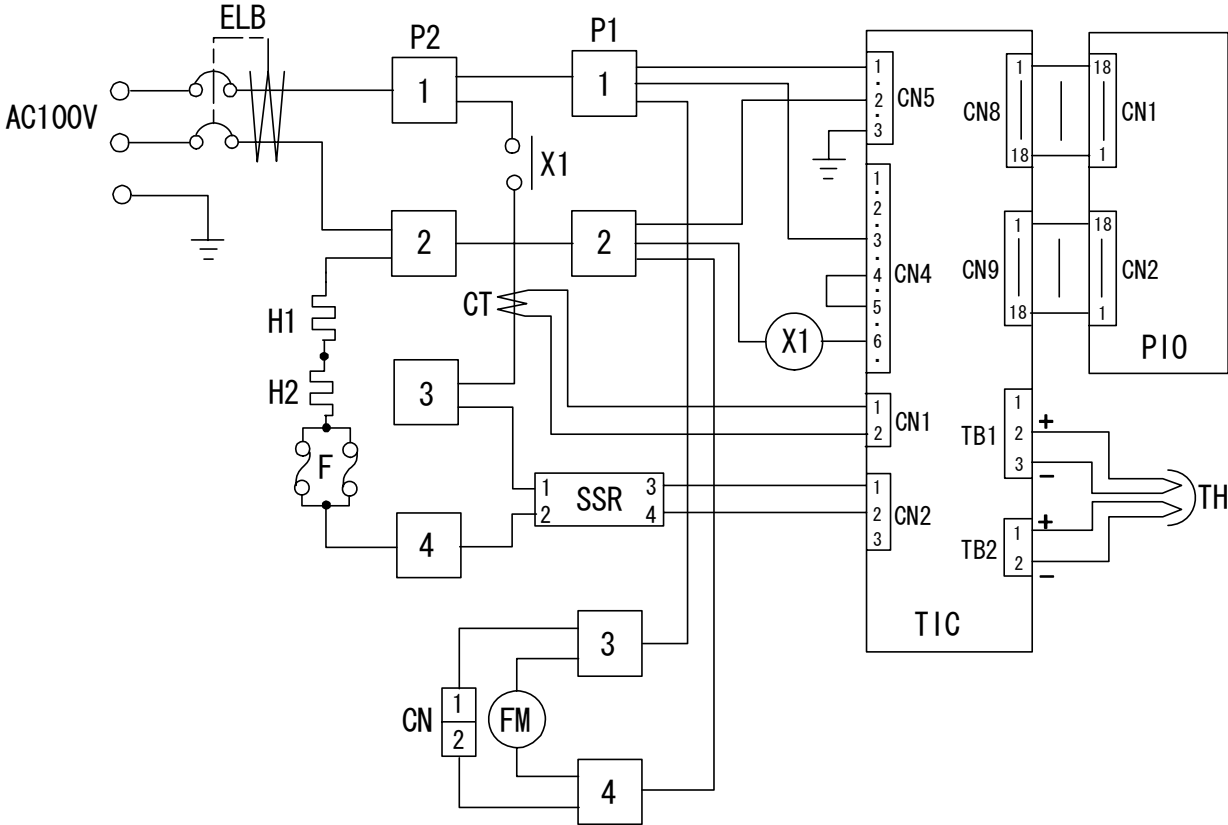

FO310/410/510

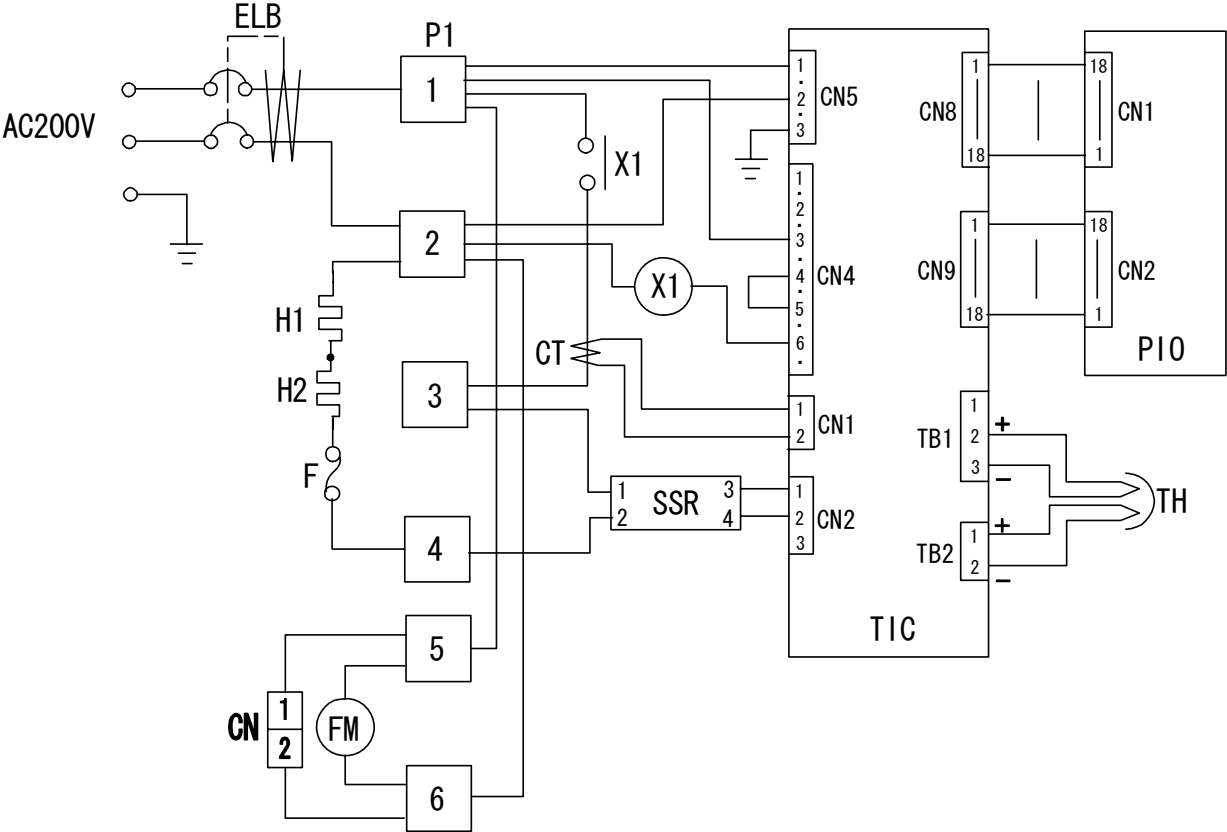

FO610/710/810

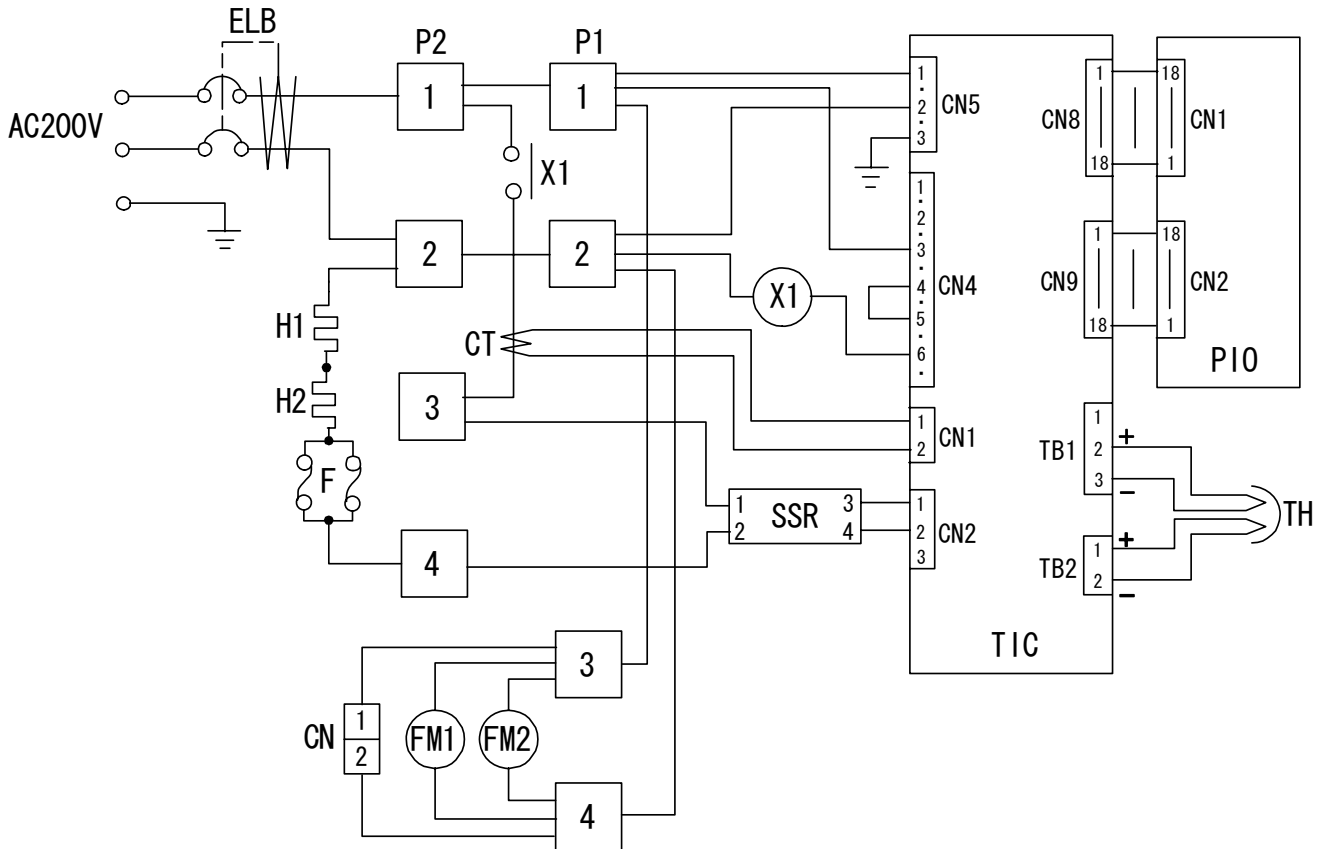

Symbol	Part name	Symbol	Part name
ELB	Earth leakage breaker	F	Thermal fuse
P1,P2	Terminal block	FM	Fan motor
CT	Current transformer	TIC	Control board
H1,H2	Heater	PIO	Display circuit board
TH	W sensor	CN	Connector for exhaust system
X1	Main relay	SSR	Solid state relay

Replacement Parts Table

Common Use Parts

Part Name	Code No.	Specification	Manufacturer
Control board (VS-4)	1-02-000-0053	VS4 Planar	Yamato Scientific
Display circuit board	1-02-000-0051	VS4 PIO	Yamato Scientific
Tough card	1-13-000-0008	300mm × 2	Yamato Scientific
Thermal fuse	LT00031819	250V 25A E8A50184C	EMERSON
Main relay for 100V	2-05-000-0019	AHE1254	Matsushita
Main relay for 200V	2-05-000-0044	AHE1255	Matsushita
Fan motor for 100V	2-15-000-0010	UF12A10BTH	FULLTECH
Fan motor for 200V	2-15-004-0007	4715PS-20T-B30-100	Minebea
Fan guard	4-37-001-0003	A-30-F	Minebea
Earth leakage breaker 15A	LT00029774	NV-L22GR 15A	Mitsubishi
Earth leakage breaker 20A	LT00029776	NV-L22GR 20A	Mitsubishi
Earth leakage breaker 30A	LT00029777	NV-L22GR 30A	Mitsubishi
W sensor	1-016-007-0001	R-thermocouple	Yamato Scientific
CT sensor	2-17-001-0005	CTL-6-S-400	URD

FO100

SSR	2-16-000-0035	TRS5225 (25A)	Toho Denshi
Heater panel	FO100-30090	Cantal AF 500W/50V/2	Yamato Scientific
Terminal block	LT00031663	TFD250ABC-6P	Terminal

FO200

SSR	2-16-000-0035	TRS5225 (25A)	Toho Denshi
Heater panel	FO200-30120	Cantal AF 750W/50V/2	Yamato Scientific
Terminal block	LT00031661	TFD250ABC-4P	Terminal
Terminal block	LT00004736	ATK-20-4P	Toyogiken

FO300

SSR	2-16-000-0036	TRS1245 (45A)	Toho Denshi
Heater panel	FO300-30050	Cantal AF 1000W/50V	Yamato Scientific
Terminal block	LT00031661	TFD250ABC-4P	Terminal
Terminal block	LT00004736	ATK-20-4P	Toyogiken

FO310

SSR	2-16-000-0035	TRS5225 (25A)	Toho Denshi
Heater panel	FO310-30000	Cantal AF 1000W/100V/2	Yamato Scientific
Terminal block	LT00031663	TFD250ABC-6P	Terminal

Replacement Parts Table

FO410

Part Name	Code No.	Specification	Manufacturer
SSR	2-16-000-0035	TRS5225 (25A)	Toho Denshi
Heater panel	LT00013749	Cantal AF 1100W/100V/2	Yamato Scientific
Terminal block	LT00031663	TFD250ABC-6P	Terminal

FO510

SSR	2-16-000-0035	TRS5225 (25A)	Toho Denshi
Heater panel	LT00013750	Cantal AF 1250W/100V/2	Yamato Scientific
Terminal block	LT00031663	TFD250ABC-6P	Terminal

FO610

SSR	2-16-000-0035	TRS5225 (25A)	Toho Denshi
Heater panel	FO610-30120	Cantal AF 1500W/100V/2	Yamato Scientific
Terminal block	LT00031661	TFD250ABC-4P	Terminal
Terminal block	LT00004736	ATK-20-4P	Toyogiken

FO710

SSR	2-16-000-0035	TRS5225 (25A)	Toho Denshi
Heater panel	FO710-30120	Cantal AF 1750W/100V/2	Yamato Scientific
Terminal block	LT00031661	TFD250ABC-4P	Terminal
Terminal block	LT00004736	ATK-20-4P	Toyogiken

FO810

SSR	2-16-000-0036	TRS1245 (45A)	Toho Denshi
Heater panel	FO810-30090	Cantal AF 2000W/100V/2	Yamato Scientific
Terminal block	LT00031661	TFD250ABC-4P	Terminal
Terminal block	LT00004736	ATK-20-4P	Toyogiken

List of Dangerous Substances



Never use explosive substances, flammable substances and substances that include explosive or flammable ingredients in this unit.

EXPLOSIVE

EXPLOSIVE:	Ethylene glycol dinitrate (nitro glycol), Glycerin trinitrate (nitroglycerine), Cellulose nitrate (nitrocellulose), and other explosive nitrate esters
	Trinitrobenzene, Trinitrotoluene, Trinitrophenol (picric acid), and other explosive nitro compounds
	Acetyl hidroperoxide (peracetic acid), Methyl ethyl ketone peroxide, Benzyl peroxide, and other organic peroxides

FLAMMABLE

IGNITING:	Lithium (metal), Potassium (metal), Sodium (metal), Yellow phosphorus, Phosphorus sulfide, Red phosphorus, Celluloid compounds, Calcium carbide, Lime phosphate, Magnesium (powder), Aluminum (powder), Powder of metals other than magnesium and aluminum, Sodium hydrosulfite
OXIDIZING:	Potassium chlorate, Sodium chlorate, Ammonium chlorate, and other chlorate
	Potassium perchlorate, Sodium perchlorate, Ammonium perchlorate, and other perchlorate
	Potassium peroxide, Sodium peroxide, Barium peroxide, and other inorganic peroxide
	Potassium nitrate, Sodium nitrate, Ammonium nitrate, and other nitrate
	Sodium chlorite and other chlorites
	Calcium hypochlorite and other hypochlorites
INFLAMMABLE LIQUID:	Ethyl ether, Gasoline, Acetaldehyde, Propylene chloride, Carbon disulfide, and other flammable substances having a flash point of lower than -30°C
	Normal hexane, ethylene oxide, acetone, benzene, methyl ethyl ketone, and other flammable substances having a flash point of -30°C or higher but lower than 0°C
	Methanol, Ethanol, Xylene, Pentyl acetate (amyl acetate), and other flammable substances having a flash point of 0°C or higher but lower than 30°C
	Kerosene, Light oil (gas oil), Oil of turpentine, Isopentyl alcohol (isoamyl alcohol), Acetic acid, and other flammable substances having a flash point of 30°C or higher but lower than 65°C
FLAMMABLE GAS:	Hydrogen, Acetylene, Ethylene, Methane, Propane, Butane, and other flammable substances which assume a gaseous state at 15°C and 1 atm

(Source: Appendix Table 1 of Article 6 of the Industrial Safety and Health Order in Japan)

Responsibility

Please follow the instructions in this document when using this unit. Yamato Scientific has no responsibility for the accidents or breakdown of device if it is used with a failure to comply. Never conduct what this document forbids. Unexpected accidents or breakdown may result in.

Note

- ◆ The contents of this document may be changed in future without notice.
- ◆ Any books with missing pages or disorderly binding may be replaced.

Instruction Manual for

Muffle Furnace

Model FO100/200/300/310/410/510/610/710/810

Third Edition Oct. 7, 2009

Revised Feb. 2, 2012

Yamato Scientific Co., Ltd.

2-1-6 Nihonbashi Honcho, Chuo-ku,
Tokyo, 103-8432, Japan

<http://www.yamato-net.co.jp>