



Forced Convection Constant Temperature Oven

Model: DNE650/670/850

Model: DNE650V/670V/850V

Instruction Manual

Second edition

- Thank you very much for purchasing this Yamato Forced Convection Constant Temperature Oven DNE Series.
 - Please read the “Operating Instructions” and “Warranty” before operating this unit to assure proper operation. After reading these documents, be sure to store them securely together with the “Warranty” at a handy place for future reference.
 - For how to operate the product, refer to this operation manual and that for the CR 5 Program Controller.
-  **Warning:** Before operating the unit, be sure to read carefully and fully understand important warnings in the operating instructions.

Yamato Scientific Co., Ltd.

1. Safety precautions	1
Explanation of pictograms	1
List of symbols	2
Warning · Cautions	3
2. Before operating the unit	4
Precautions when installing the unit	4
Installation procedures/precautions	9
3. Names and functions of parts	10
Main unit	10
Operation panel	12
4. Operating procedures	14
Operation modes and lists of functions	14
Overheat protector settings	16
Useful functions (Temperature output)	17
Useful functions (RS485 communication function)	19
5. Cautions on handling	33
6. Maintenance procedures	35
Daily inspection/maintenance	35
7. When the unit is not to be used for a long time or when disposing	36
When the unit is not to be used for a long time or when disposing	36
Notes about disposition	36
8. Troubleshooting	37
Safety device and error codes	37
When a malfunction is suspected	38
9. After sales service and warranty	39
When requesting a repair	39
10. Specifications	40
11. Wiring diagram	41
12. Replacement parts list	44
13. List of dangerous materials	46
14. Standard installation manual	47

1. Safety precautions

Explanation of pictograms

About pictograms

A variety of pictograms are indicated in this operating instruction and on products for safe operation. Possible results from improper operation ignoring them are as follows.

Be sure to fully understand the descriptions below before proceeding to the text.

 **Warning** Indicates a situation which may result in death or serious injury (Note 1.)

 **Caution** Indicates a situation which may result in minor injury (Note 2) and property damages (Note 3.)

(Note 1) Serious injury means a wound, an electrical shock, a bone fracture or intoxication that may leave after effects or require hospitalization or outpatient visits for a long time.

(Note 2) Minor injury means a wound or an electrical shock that does not require hospitalization or outpatient visits for a long time.

(Note 3) Property damage means damage to facilities, devices and buildings or other properties.

Meanings of pictograms



This pictogram indicates a matter that encourages the user to adhere to warning ("caution" included).
Specific description of warning is indicated near this pictogram.



This pictogram indicates prohibitions
Specific prohibition is indicated near this pictogram.



This pictogram indicates matters that the user must perform
Specific instruction is indicated near this pictogram.

1. Safety precautions

List of symbols

Warning



General warnings

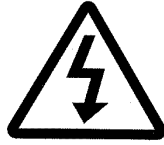

Danger!: High voltage



Danger!: High temperature



Danger!: Moving part



Danger!: Hazard of explosion

Caution



General cautions



Electrical shock!



Burning!



Caution for no liquid heating!



Caution for water leak!



For water only



Poisonous material

Prohibitions



General bans



Fire ban



Do not disassemble



Do not touch

Compulsions



General compulsions



Connect ground wire



Install levelly



Pull out the power plug



Regular inspection

1. Safety precautions

Warning · Cautions

Warning



Never operate the unit in an atmosphere containing flammable or explosive gas

Never operate the unit in an atmosphere containing flammable or explosive gas. Otherwise, an explosion or a fire may result since the unit is not explosion-proof. See section "13. List of dangerous materials" on page 45.



Be sure to connect the ground wire.

Be sure to connect the ground wire correctly. Otherwise, electrical leak may result and cause an electrical shock or a fire.



Ban on operation when an abnormality occurs

When a smoke or an unusual odor is seen or sensed, immediately turn the ELB on the main unit off and pull out the power plug. A fire or an electrical shock may result.



Never use electrical power cords bundled.

When these are used bundled, they might overheat causing a fire.



Take care not to damage electrical power cords.

Avoid tightly bend, pull with a strong force or twist to prevent electrical power cords from damaging. A fire or an electrical shock may result.



Never use an explosive or a flammable material with this unit.

Never use an explosive material, a flammable material or a material containing them. An explosion or an electrical shock may result. See section "13. List of dangerous materials" on page 45.



Never try to touch a hot part.

Some parts of the unit are hot during and immediately after operation. Take special care for possible burning.



Never try to disassemble or alter the unit.

Never try to disassemble or alter the unit. A malfunction, a fire or an electrical shock may result.



Caution



When a thunder is heard.

When a thunder is heard, turn the main power off immediately. A malfunction, fire or an electrical shock may result.

2. Before operating the unit

Precautions when installing the unit

1. Carefully select an installation site.



Take special care not to install the unit at a place described below:

- Uneven surfaces or dirty surfaces
- Where flammable gas or corrosive gas exists
- Where the ambient temperature is 35°C or more
- Where temperature changes severely
- Where humidity is high
- Where subject to direct sunlight
- Where vibration is severe



Install this unit at a place with spaces shown below.

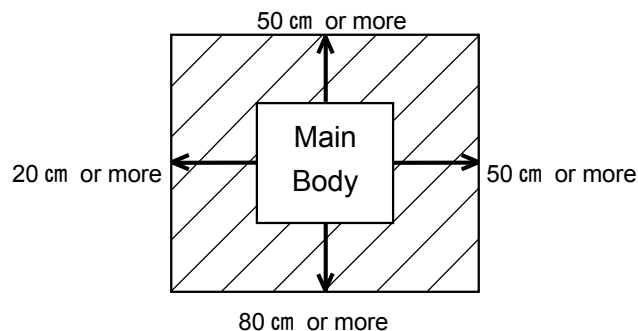

2. Install the unit on a level surface.



Install the unit on a level surface. If the whole bottom surface of the unit does not contact the surface evenly, vibrations or noises may result. This might cause unexpected troubles or malfunctions.

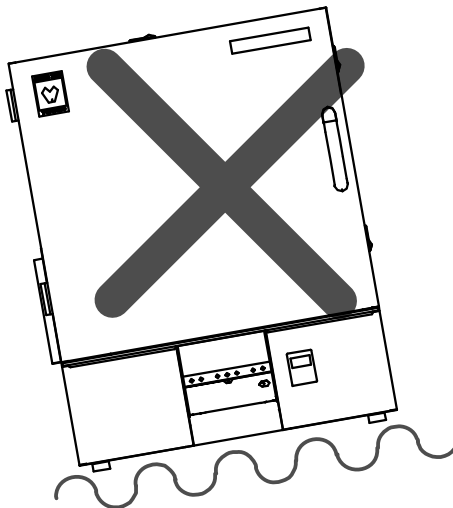

The unit weight: DNE650 (V)/670 (V) : Approx.90 kg、DNE850 (V) : Approx.130 kg
When lifting the unit for transportation and installation, carefully handle it by at least two people.

3. Installation



The unit might fall down or move by an earthquake or an impact resulting a personal injury.
We recommend making safety measures such as to avoid installing the unit at a place other than busy places.

2. Before operating the unit

Precautions when installing the unit

4. Secure sufficient ventilation for the unit.



Do not operate the unit when suction port and heat radiation port on the side and rear panels are blocked.

Internal temperature of the unit will rise degrading the performance and an accident, a malfunction or a fire may result.

5. Do not operate the unit at such a place that may subject to splash.



Do not operate the unit at such a place that may subject to splash. Liquid entering the inside may cause an accident, a malfunction, an electrical shock or a fire.

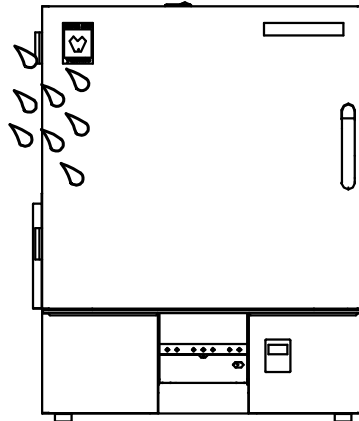

6. Never operate the unit in an atmosphere containing flammable or explosive gas.



Never operate the unit in an atmosphere containing flammable or explosive gas. Since the unit is not explosion-proof, an arc is discharged when switching the ELB "ON" and "OFF" and during operation and a fire or an explosion may result.



See the section "13. List of dangerous materials" on page 46 for flammable and explosive gases.

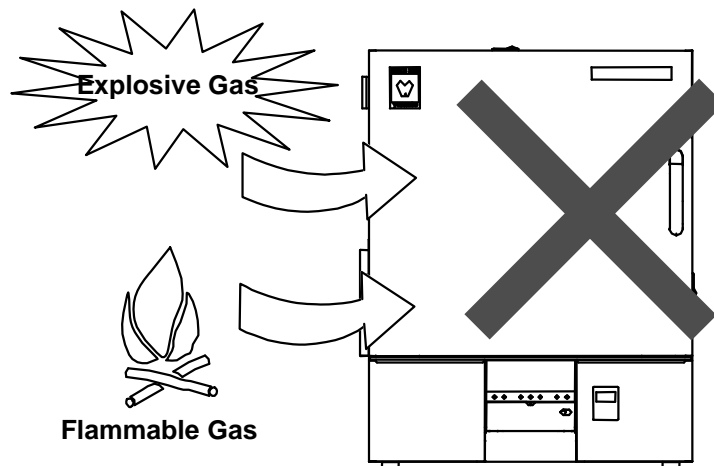

2. Before operating the unit

Precautions when installing the unit

7. Be sure to connect the power plug to the dedicated power distribution panel or a wall outlet.



Use a power distribution panel or a wall outlet that meets the electrical capacity of the unit.

Electrical capacity:	DNE650 (V)	AC100V-120V	14~16.5A
	DNE670 (V)	AC200V-240V	7~8.5A
	DNE850 (V)	AC200V-240V	12.5~15A

- * When the unit will not start even when you turn the Electric Leakage Breaker to "ON", check for low main voltage or if the unit is connected to the same power supply line as other devices and connect it to another line if necessary.

Avoid connecting too many devices using a branching outlet or extending a wire with a cord reel or heating function and temperature controlling function may degrade due to voltage drop.



Do not connect the unit to any parts or lines other than a correct power supply line such as a gas pipe, a water pipe or a telephone line. Otherwise, an accident or a malfunction may result.

8. Handling of a power cord



Never use electrical power cords bundled. When these are used bundled, they might overheat causing a fire.

Do not convert, forcibly bend, twist or pull the power cord. Otherwise, a fire or an electrical shock may result.

Do not place the power cord under a desk or a chair, or sand between objects to avoid it from being damaged.

Otherwise, a fire or an electrical shock may result.

Do not place the power cord close to a stove or other heat generating device. Sheath of the cord may burn and result in a fire or an electrical shock.



If the power cord should be damaged (exposure of core wire or disconnection), immediately turn the ELB off, turn the power supply off and ask your dealer to replace the cord. If the unit is operated with a damaged power cord, a fire or an electrical shock may result.



Connect the power cord to an appropriate wall outlet or distribution board.

9. Be sure to connect the ground wire.



- When the unit has no ground terminal, class D grounding work is necessary and please consult your dealer or our nearest sales office.
- Securely connect to an outlet.

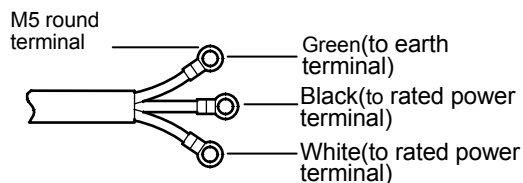

The unit does not have a power plug. Connect the earth correctly to suit the power facility to be connected.



Do not connect the grounding wire to any parts or lines other than a correct grounding terminal such as a gas pipe, a water pipe or a telephone line. Otherwise, an accident or a malfunction may result.

2. Before operating the unit

Precautions when installing the unit

10. Be careful for the colors of core wires when connecting the power cords.



Be sure to first make sure that the breaker on the power facility side is "Off" before connecting the power cords. The unit does not have a power plug. Select and connect a plug and a terminal with correct ratings suited to the power source capacity of the power facility to be connected. (See the table in the right)

Core wire color	Indoor wiring
Black	Voltage side
White	Earth side
Green	Earth

11. Do not attempt to alter the unit



The customer shall never attempt to alter the unit. Otherwise a malfunction may result.

Modification

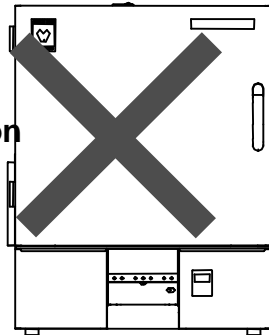

12. Do not put too many specimens.



The withstand load of a shelf board is 15kg when the load is evenly distributed. Put specimens dispersed.

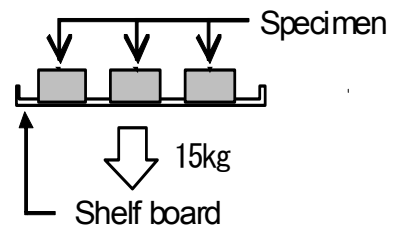

13. Do not set too many specimens.



Too many specimens will prevent correct temperature control. In order to assure temperature precision, be sure to use shelf boards and put specimens dispersed, and secure at least 30% of space inside the bath.

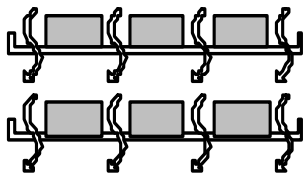

Secure at least 30% of space

14. Do not place an object on the bottom plate.



Operating the unit with placing the specimen directly on the bottom plate of the internal bath will prevent performance of the product from fully exerting, increase the internal temperature excessively and may cause a malfunction. Never place a specimen on the bottom plate of the internal bath.

2. Before operating the unit

Precautions when installing the unit

15. Placing shelf boards and specimens



Shapes of shelf boards will differ depending on the model and each model contains two to four boards.

One of them has been fixed on the lowest stage of the shelf peg pillars inside the unit with screws at the time of factory shipping.

Set the remaining shelf boards to appropriate positions in the unit.



One of the shelf boards has been fixed on the lowest stage of the shelf peg pillars inside the unit with screws at the time of factory shipping.

A heater and a fan are installed under the rectifier plate. And temperature of the rectifier plate and around it is always higher than the set temperature and if you place a specimen directly on the plate, it may burn or a fire may result.

Slit at the front side of the rectifier plate is the suction slit of the hot air convection route. Never block this slit with a specimen or other objects.

For this reason, the shelf boards are held with screws as shown in the drawing to prevent specimens from being placed directly.

If you need to remove shelf boards due to the shape of a specimen to set, secure sufficient space to the rectifier plate and never place the specimen directly.

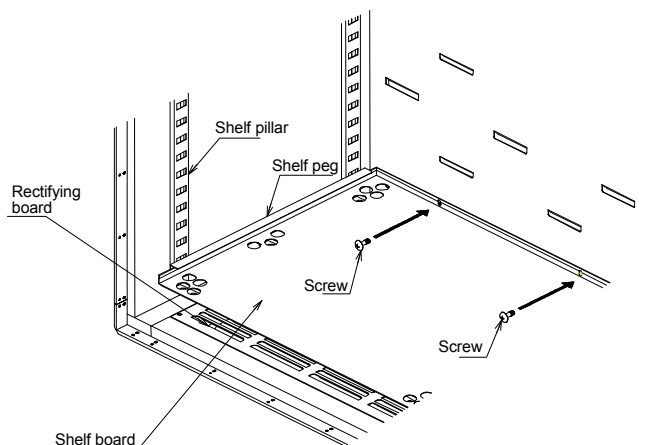

16. About handling of the exhaust port



Open the suction port at the lower part of the right side of the main unit when you want to use the exhaust port at the ceiling of the main unit (rear side for DNE850/850V). Take special care for burning when operating the air suction and exhaust ports become hot because they will become hot.

17. About handling of specimens



Forced convection is performed to assure proper temperature distribution in the bath. Make sure that specimen will not fly when processing powder or small specimens. A fire or an electrical shock may result if a flammable object or a metal part is dropped in the heater assembly.



It might take time for temperature to increase when the amount of specimens is considerable or when processing a specimen of larger heat load. Check the appropriate amount of specimens as necessary before setting them.

Also note that the displayed temperature may become unstable when processing a heat-producing specimen (limited to those are free of its explosion, firing, or ignition).

Precautions when installing the unit

Installation procedures/precautions

- (1) Release the stopper lock of the caster wheels.

Set the stoppers of the caster wheels to the high position as shown in the drawing in the right.

Now the lock is released.

(Only two caster wheels at the front of the unit have stoppers.)

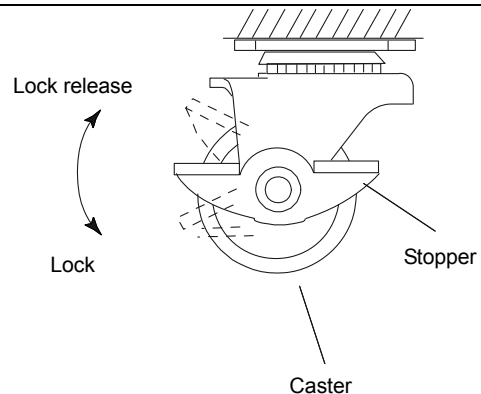

- (2) Transport the unit to the installation site.

*Transporting the unit over a gap may give an excessive shock to the caster wheels and may damage them.

If such trouble is expected, lift the unit and transport it over the gap.

- (3) Lock the caster stoppers when the unit has been transported to the installation site.

They are locked.

- (4) Connection of the power supply.

Make sure that the ELB is "OFF" before connecting the power supply to the power distribution board and the outlet.

- (5) Set the power voltage selector switch.

Set the power supply voltage selector switch at the rear of the main unit to the power supply voltage to be used.

Model DNE650/650V

• For 100~110V

100~110V 115~120V

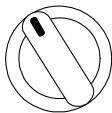

• For 115~120V

100~110V 115~120V

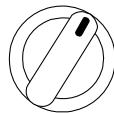

Model DNE650/650V

• For 100~110V

100~110V 115~120V

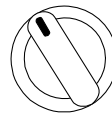

• For 115~120V

100~110V 115~120V

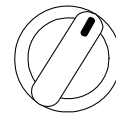

- (6) Set the power supply voltage of the controller.

Turn the ELB "ON" and set the power supply voltage of the controller to the power supply voltage to use.

The voltage is set at 100V for the model DNE650/650V and 200V for the models DNE670/670V/DNE850/850V at the time of factory shipping.

Refer to "2. Power supply voltage setting" on P.45 of the separate "Operation manual for the Program Controller model CR5" for how to make settings.

3. Names and functions of parts

Main unit

Front side of DNE650 (V) /670 (V)

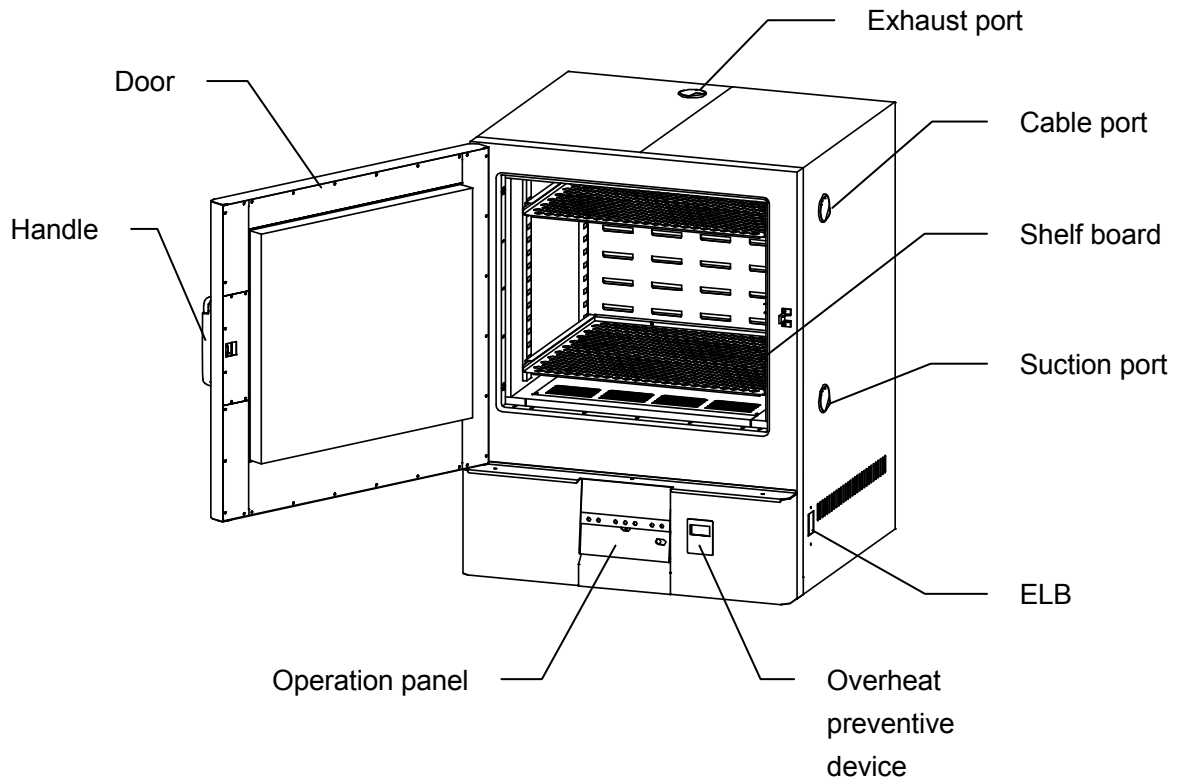

Rear side of DNE650 (V) /670 (V)

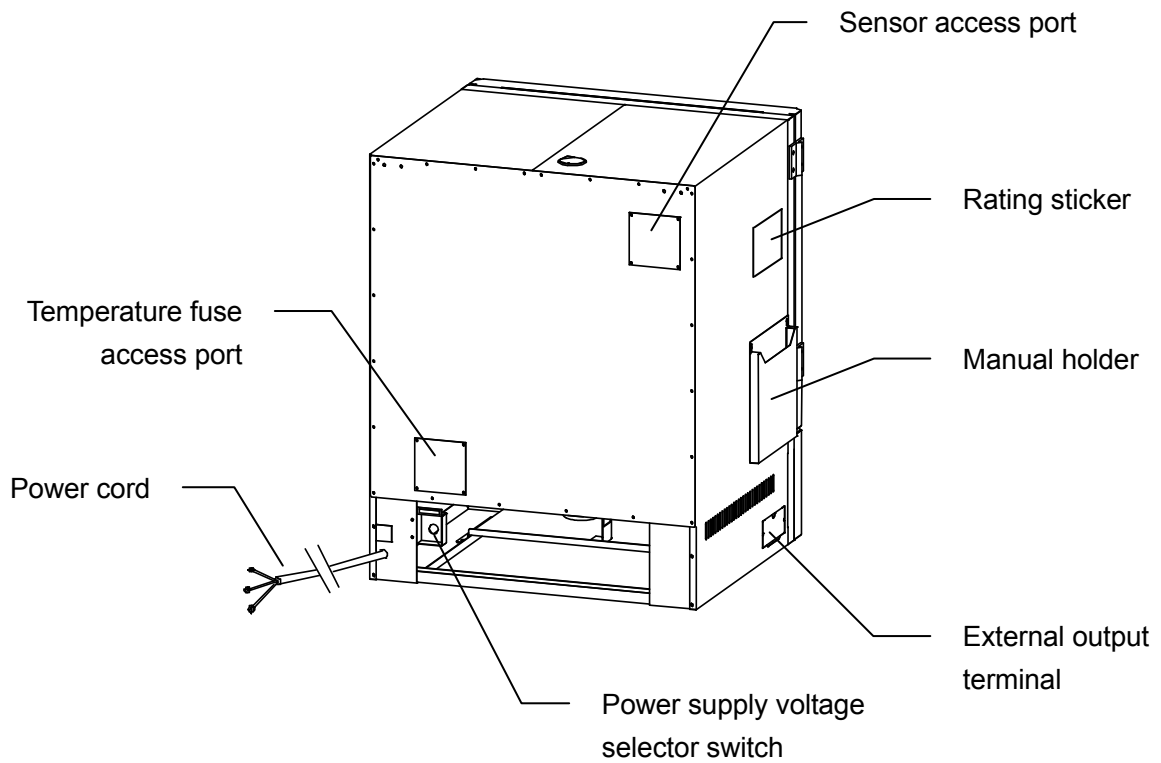

3. Names and functions of parts

Main unit

Front side of DNE850 (V)

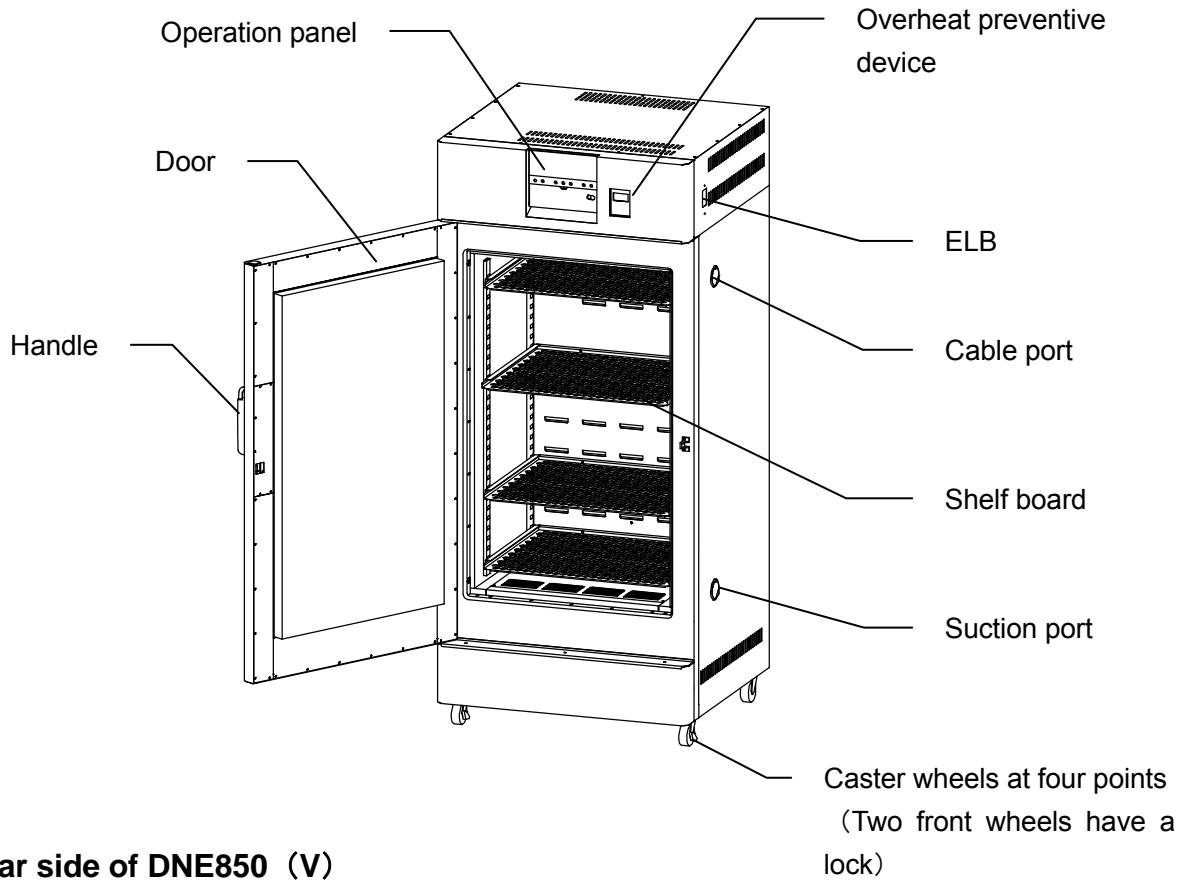

Rear side of DNE850 (V)

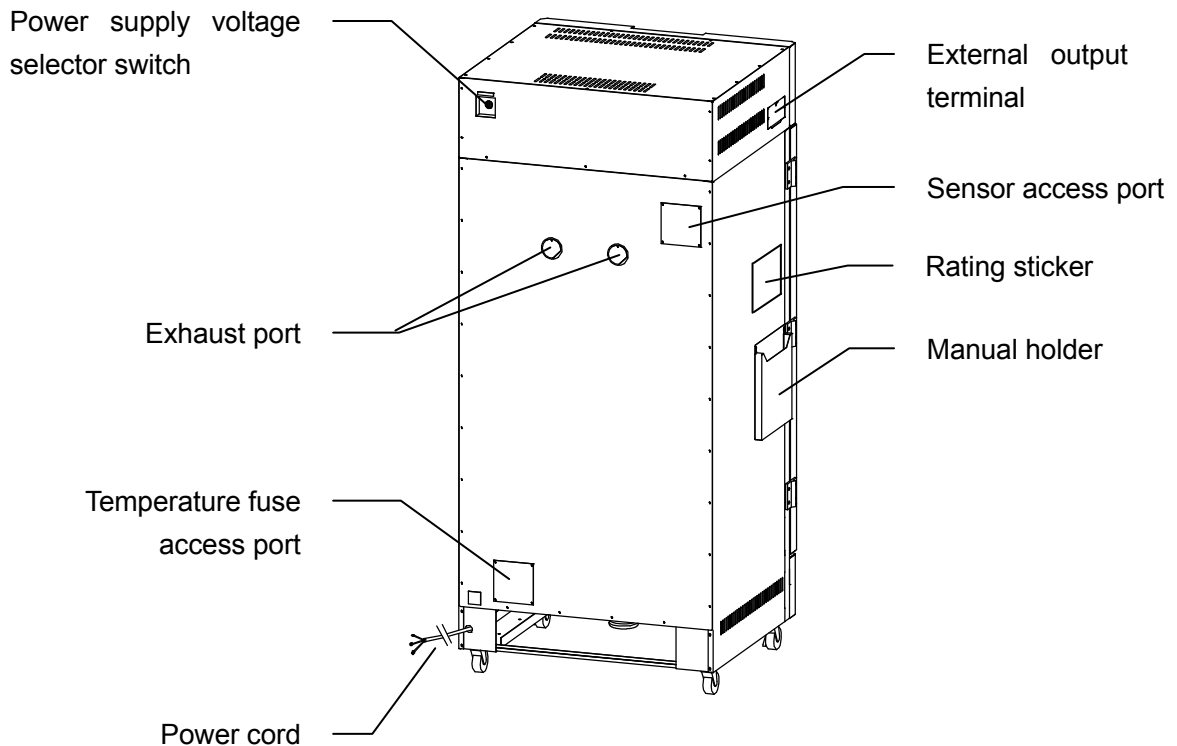

3. Names and functions of parts

Operation panel

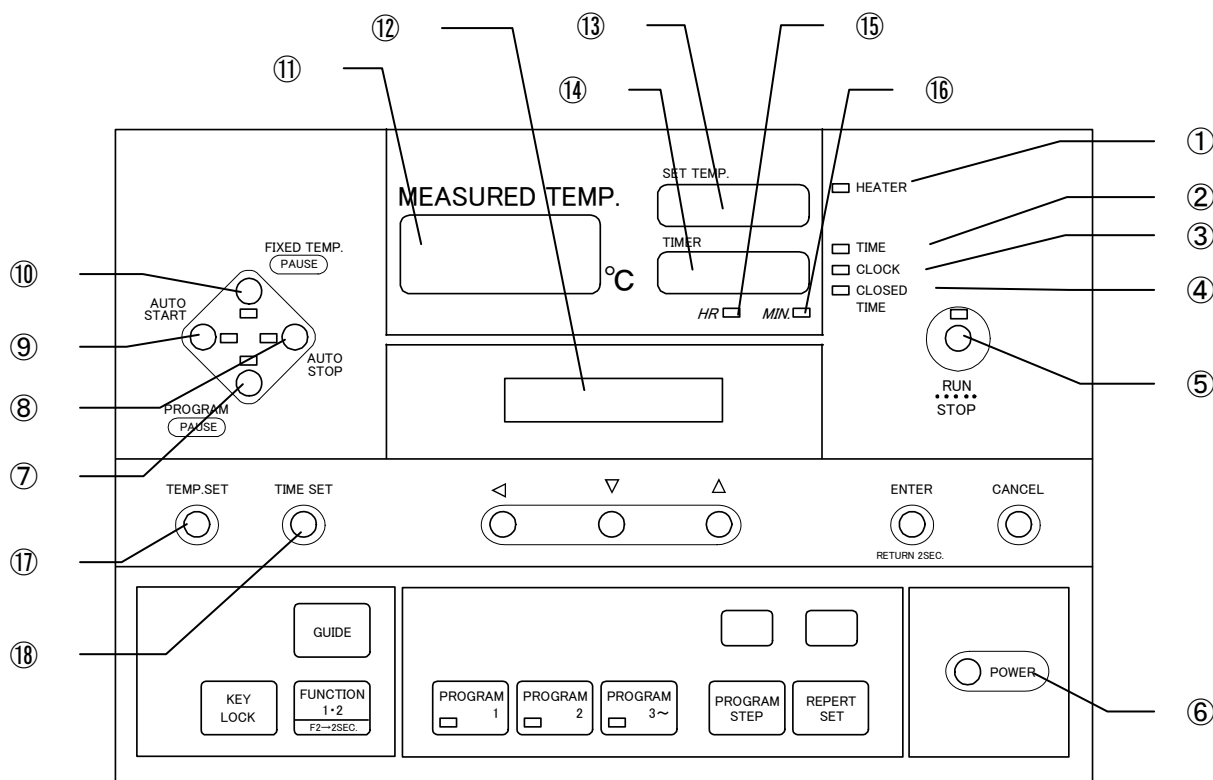

NO.	Name	Operation / action
①	HEATER lamp	Lights when the heater is turned on.
②	HOUR lamp	Lights when the timer is set in hours.
③	TIME lamp	Lights when the timer is set in clock time.
④	REMAINING HOUR lamp	Lights when the Timer screen displays the remaining operation time.
⑤	RUN/STOP key	The key is used to start/stop specific operation.
⑥	POWER key	The key is used to turn on or off the power to the controller.
⑦	PROGRAM key	The key is used to select program operation.
⑧	AUTO STOP key	The key is used to select auto stop operation.
⑨	AUTO START key	The key is used to select auto start operation.
⑩	FIXED TEMP key	The key is used to select fixed temperature operation.
⑪	Measured Temperature Display Screen	The screen displays the measured temperature and error numbers.
⑫	Operation Guide Screen	The screen describes status.
⑬	Set Temperature Display Screen	The screen displays the set temperature and parameter settings.
⑭	Timer Display Screen	The screen displays the set time and the remaining hours.
⑮	HOUR UNIT lamp	The lamp comes on when the time setting is the hour.
⑯	MIN UNIT lamp	The lamp comes on when the time setting is the minute.
⑰	TEMP. SET key	The key is used to set or change temperature for the fixed temperature operation or program operation.
⑱	TIME SET key	The key is used to set or change time for the fixed temperature operation or program operation.

3. Names and functions of parts

Operation panel

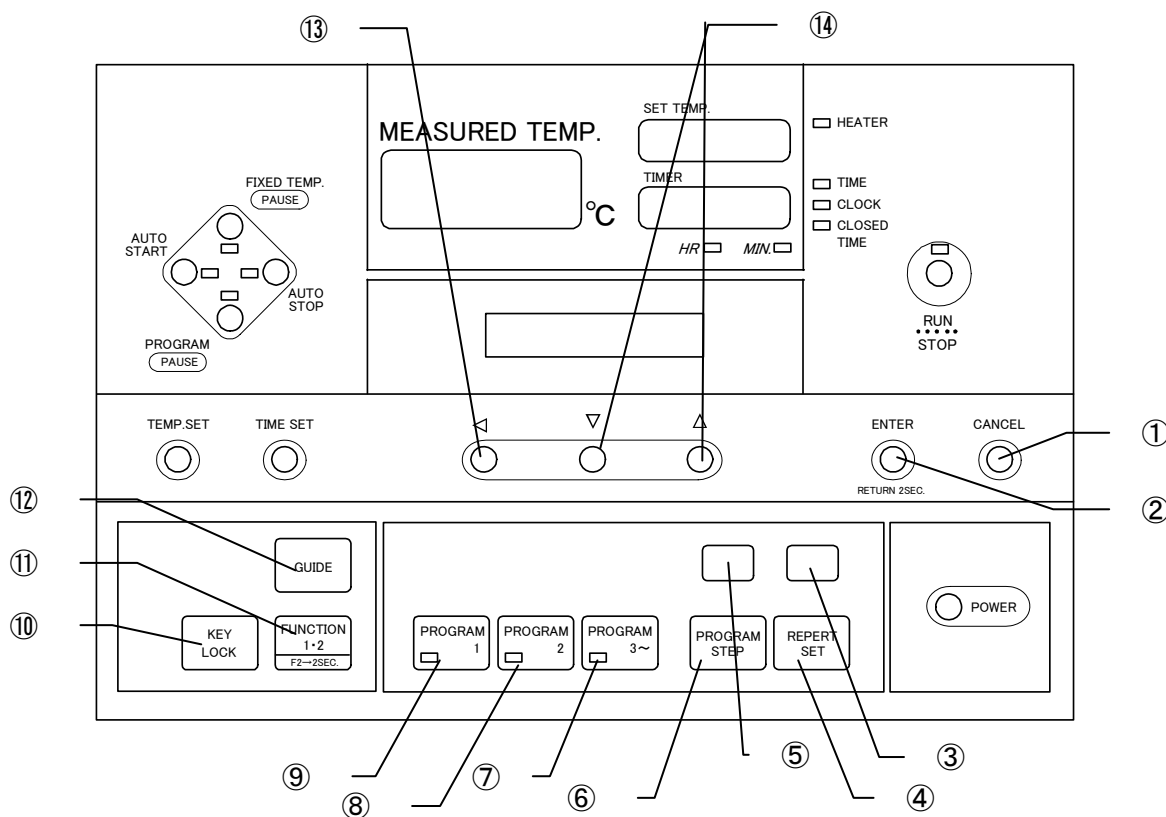

No.	Name	Operation/action
①	CANCEL key	The key is used to go back to the previous parameter item or to clear parameter settings.
②	ENTER key	The key is used to advance to the next parameter item or to determine a parameter setting.
③	Repeat Display Screen	The screen displays repeat setting and the number of repetitions.
④	REPEAT SET key	The key is used to set repeat during program operation.
⑤	Step Display Screen	The screen displays the selected step and steps to be executed.
⑥	STEP key	The key is used to set steps for program operation.
⑦	PROGRAM 3 key	The key is used to select program 3.
⑧	PROGRAM 2 key	The key is used to select program 2.
⑨	PROGRAM 1 key	The key is used to select program 1.
⑩	LOCK key	The key is used to lock settings.
⑪	FUNCTION 1/2 key	The key is used to set various functions of the controller.
⑫	GUIDE key	The key is used to show guidance on the Operation Guide screen.
⑬	DIGIT SHIFT key	The key is used to shift a digit during setting.
⑭	\blacktriangledown \blacktriangle keys	The keys are used to increase/decrease settings.

4. Operating procedures

Operation modes and lists of functions

There are six operation modes as shown below.

Refer to the separate "Operation Manual for the model CR5 Program Controller" for details.

No.	Name	Function
1	Fixed Temp. operation	Controls temperature at a constant temperature.
2	Auto Stop operation	Stops operation at a set time.
3	Quick Auto Stop operation	Allows setting auto stop operation during fixed temperature operation.
4	Auto Start operation	Starts operation at a set time.
5	Program operation	Performs program operation.
6	Program Auto Start operation	Starts program operation at a set time.

The function menu shows the following 16 functions (including when optional devices are installed).

Refer to the separate "Operation Manual for the model CR5 Program Controller" for details.

No.	Name	Function
Functions of FUNCTION 1		
1	Display language setting	This function is used to select Japanese or English as the display language.
2	Power supply voltage setting	This function is used to select the power supply voltage to use.
3	Calendar/Time setting	You can set the dominical year, month, date and the current time.
4	Time/Hour selection	You can select whether timer operation will be set in hours or in time.
5	Buzzer setting	You can turn on or off sound of key operation, time up, operation disabled and door open separately.
6	Heater output operation level display	The heater output level in % can be continuously monitored.
7	Electricity/electric power charge display	You can monitor the basic unit for electric power charge calculation, electric power volume and charge for various units from an hour to a year, total electric power charge, electric power volume and charge for one cycle operation.
Functions of FUNCTION 2		
8	Motor output setting	This function is used to set rotation and stop of the fan motor.
9	Calibration offset setting	The function is used to compensate a calibration offset temperature.
10	External communication setting	The function is used to set conditions for external communication.
11	Power failure compensation function setting	The function enables you to set whether to continue or hold the operation after recovery from a power failure.
12	Wait function setting	The function is used to set a wait zone and a wait time. This setting may not be different among different steps.
13	Accumulated time display	The display allows monitoring of accumulated time of operation of the controller (unit).
14	Warning history display	The display allows monitoring of error information of 20 incidents in the past.

4. Operating procedures

Operation modes and lists of functions

Refer to the separate "Operation Manual for the Model CR5 Program Controller" for details of operations.

No.	Operations	Corresponding page in the operation manual for the model CR5 Program Controller.
1	Description of the Control Panel	P. 1
2	Fixed Temperature Operation	P. 10
3	Fixed Temperature Auto Stop Operation	P. 11
4	Fixed Temperature Quick Auto Stop Operation	P. 12
5	Fixed Temperature Auto Start Operation	P. 13
6	Program Operation	P. 14
7	Program Auto Start Operation	P. 34
8	Program Step change Function	P. 35
9	Lock Settings	P. 40
10	Guide Function	P. 42
11	Suspension Function	P. 43
12	Program Pattern Registration Function	P. 28
13	Program Pattern Assignment Function	P. 25
14	Settings of FUNCTION 1	P. 44
15	Settings of FUNCTION 2	P. 52

4. Operating procedures

Overheat protector settings

The stand-alone overheat protector consists of a temperature measurement circuit, CPU, sensors, and the output circuit separate from the controller. When the protector is activated, the unit will stop and will not recover until the earth leakage breaker is turned on again. (Manual recovery)

Temperature setting for the stand-alone overheat protector

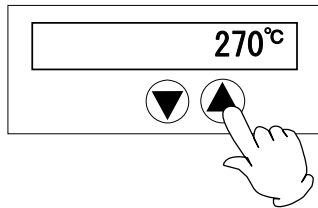

- ① Set the temperature with the ▼▲ keys.

About the stand-alone overheat protector



When the difference in the set temperatures between the stand-alone overheat protector and the controller is small, the protector may be activated and operation may be stopped. Set the temperature for the protector at least 10°C higher than that for the controller. Note that the protector is not available for the purpose of protecting specimens.

The temperature is set at 270°C at the time of shipping.

If you want to operate the stand-alone overheat protector at a temperature you want, first operate the unit with the temperature in the bath at that setting until operation becomes stable, then gradually lower the protector setting and make sure that it operates reliably at the temperature setting you want. It takes about five seconds before it starts operation for which time you have to wait before checking. When the protector is triggered, it displays Er07 and operation stops. Since the activation temperature for the sensor of the protector differs depending on overshoot at the time of heating or specimen status, set it at as high temperature as possible.

Also, when the protector set temperature has been changed, wait for about five seconds until that temperature is recorded before turning power off.

4. Operating procedures

Useful functions (Temperature output)

Before operating the unit



Be sure to follow instructions in this manual for operating the product. Operations other than those specified in this manual may cause a trouble. Also take care that the warranty may be void if any operation other than those specified in this manual is performed.



CAUTION



1. Be sure to turn the breaker OFF before making any connections. (Refer to P.18))
2. Be sure to use the unit at or below the rated capacity when you use the alarm output and the time-up output.
3. Make any connection secure with the screws attached to the terminal block.

Connecting procedures



- Securely connect to the terminal to be used.
- The alarm output and the time-up output are “ON” (relay contact closed) at the time of outputting.
- When temperature output is used, use a shielded cable to prevent noises.

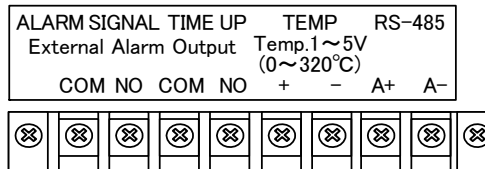

Connecting terminals

4. Operating procedures

Useful functions (Temperature output)

Specifications

Temperature output (ANALOG)	<ul style="list-style-type: none"> • Outputs a voltage (DC) according to the measured temperature • Output temperature range : 0~320°C • Output voltage : DC1~5V • Resolution : $\pm 1.6^{\circ}\text{C}$ • Connection : M4 screw terminal block
Alarm output (ALARM)	<ul style="list-style-type: none"> • Outputs when an abnormality is detected (For description of abnormalities, see "Safety device and error codes" on P.37.) • A-contact (relay contact) • Contact capacity : AC250V 3A (resistance load) DC30V 3A (resistance load) • Connection : M4 screw terminal block
Time up output (TIME UP)	<ul style="list-style-type: none"> • Outputs on time-up of AUTO STOP, AUTO START or QUICK AUTO STOP or at program end. • A-contact (relay contact) • Contact capacity : AC250V 3A (resistance load) DC30V 3A (resistance load) • Connection : M4 screw terminal block

Temperature output (ANALOG)

Temperature (°C)	Output voltage (V)
0	1.00
20	1.25
40	1.50
60	1.75
80	2.00
100	2.25
120	2.50
140	2.75
160	3.00
180	3.25
200	3.50
220	3.75
240	4.00
260	4.25
280	4.50
300	4.75
320	5.00

4. Operating procedures

Useful functions (RS485 communication function)

1. Communication settings

1.1 Communication settings

Make communication parameter settings on the PC side before starting communication with the CR5 controller (hereafter, "this Unit").

	Item	Communication settings
1	Data length	8 bits
2	Stop bit length	2 bits
3	Parity	None
4	BCC check	Enabled
5	Communication rate	4800BPS
6	Response delay time	0msec

1.2 Connection for communication

■ PC

- One RS232C interface channel (COM1/COM2 port) is used.

■ RS232C/RS485 converter

- We recommend a converter KS-485 of System Sacom.
- By purchasing our non-standard accessory "external communication adaptor (RS485-232C) ODK18", you can make following connection. (PC unit is excluded.)
- Sample program can be viewed in our home page.
<http://www.yamato-net.co.jp/support/program/index.htm>

■ Connection communication cable

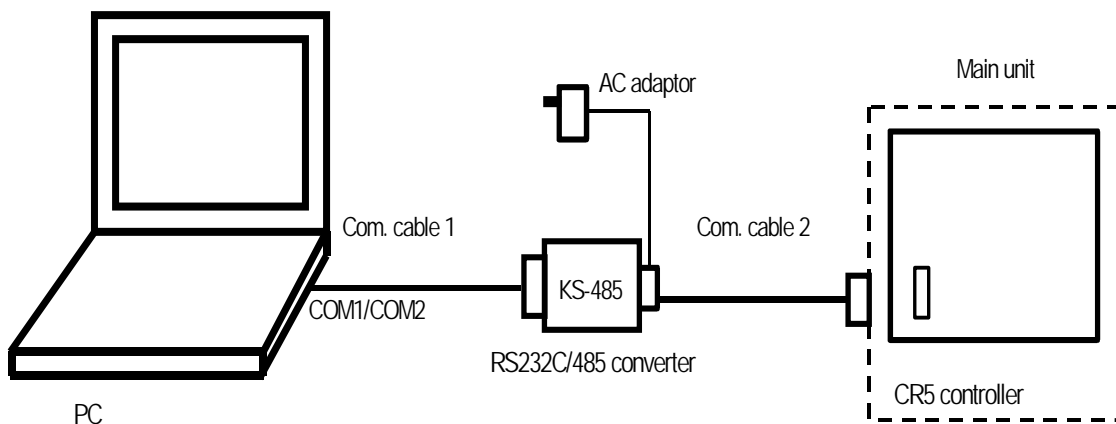

Note 1) Configuration of the non-standard accessory, "external communication adaptor (RS485-232C) ODK18" is as follows.

- ① Com cable 1 : PC side connector (for connecting IBM9 pin device)RS-232C cable 1m, KS-485 side connector (Dsub25 pin, male) System Sacom CBL16
- ② Com cable 2 : KS-485 side connector (Dsub9 pin, male) UL2464TASB 2-core AWG20 cable 3m, with a Y-terminal on the device side (with terminal resistance of 100Ω)
- ③ RS-232C↔KS-485 converter unit : System Sacom KS-485, with an AC adaptor

4. Operating procedures

Useful functions (RS485 communication function)

2. Data transmission system

Item	Specifications
Communication standard	EIA standard RS-485 compliant
Synchronization system	Asynchronous system
Communication system	Half-duplex communication
Transmission code	ASCII code
Communication rate	1200/2400/4800/9600BPS
Communication dist.	Max.500m (depends on environmental influences)
Network	Multi-drop system (Max. 1:31 stations)
Signal wire	Two wires: transmission/reception
Stop bit length	1/2bits
Data length	7/8bits
Parity	None/Odd/Even
BCC check	Enabled/Disabled
Response delay time	0~250msec
Communication address	1~99 stations (Max. 1:31 stations)
Communication mode select	RO/RW

Note) Settings indicated in are the initial settings of the Unit.

3. Transmission control characters

Symbol	Name	Code	Description
STX	Start of text	02H	Indicates the beginning of a text
ETX	End of text	03H	Indicates the end of a text
R	Read	52H	Command to read a request
W	Write	57H	Command to write a request
ACK	Acknowledge Character	06H	Transmission of acknowledgement of proper reception
NAK	Negative Acknowledge	15H	Transmission of reply of reception error

Note) R : Read (Command to read settings or measurements)

W : Write (Command to write settings)

R command can be always available for communication in any mode.

W command is available for communication only in the normal mode and its specific parameters that can be communicated differ depending on the operating status (during operation). See "7. List of identifiers/commands".

4. Transmission control procedures

4.1 Communication procedures

- The Unit returns "reply message" in response to a "request message" from a host PC.
Thus, the Unit will never start transmission.
- The Unit does not make any communication for about four seconds after power on (no reply).
Set some delay before start of communication after power on.

4. Operating procedures

Useful functions (RS485 communication function)

4.2 Message types

- Types of messages include the transmission request message from a host PC and the transmission reply message from the Unit.
- All code (excluding BCC) including STX, address, request content, identifier, and ETX are expressed in ASCII codes.

4.3 Configuration of the request message (Transmission from a host PC to the Unit)

4.3.1 Configuration of the read request message

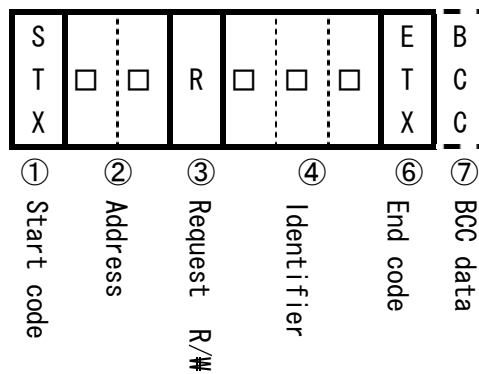

4.3.2 Configuration of the write request message



4. Operating procedures

Useful functions (RS485 communication function)

4.4 Configuration of the reply message

4.4.1 Reply message in response to the read request message

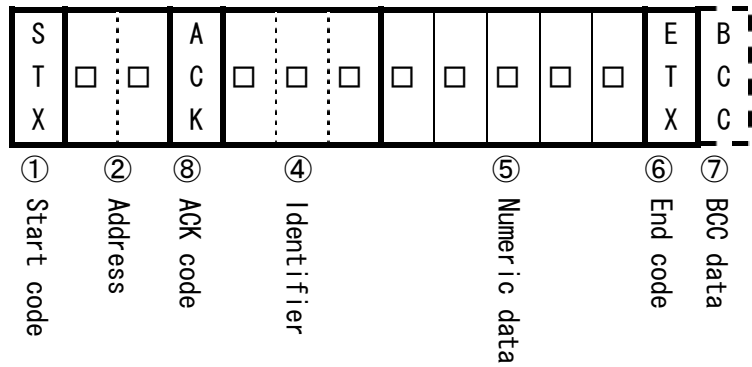

4.4.2 Reply message in response to the write request/store request messages

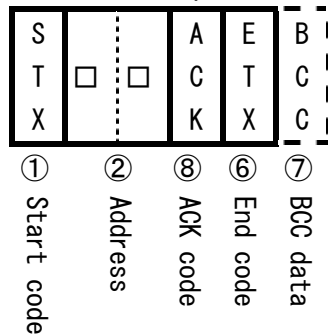

4.4.3 Reply message when an error occurs

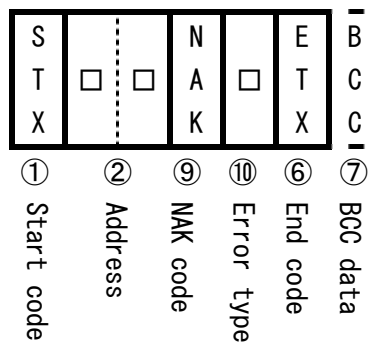

4. Operating procedures

Useful functions (RS485 communication function)

4.5 Description of codes

- Codes below from ①STX, ②Address ⑩Error type are expressed in ASCII codes.
- For ASCII codes, see “8.ASCII code list”.
- For conversion to ASCII codes, see “5.Communication example”.

① STX

This code is necessary for the receiving side to detect the beginning of a message. This is prefixed to the beginning of the character string to be transmitted.

② Address

This is the address of the counterpart (the Unit) for communication with a host PC. The address within a reply message from the Unit indicates the transmission source of the reply message.

③ Request

Indicate R or W symbol.

R : When data is read out from the Unit

W : When data is written into the Unit or stored in the Unit.

④ Identifier

This is a classification symbol (identifier) for data to be read out or written and is expressed in a three-digit ASCII code. See “7. Identifier/command list”.

⑤ Numeric data

This is data to be read out or written all of which are expressed in a five-digit number irrespective of their type.

Minus data : The “-” symbol is indicated at the first digit.

Decimal point position : A five-digit data does not contain a decimal point.

Example) Five-digit numeric data 0 0 1 0 1 has the following meanings:

Example		Meaning
Set temp. (SV1)	When temp. sensor is a thermocouple	→ 101°C
	When temp. sensor is of platinum	→ 10.1°C
Set time (TIM)		→ 1 hr 1min

⑥ ETX

This is a code necessary for the receiving side to detect the end of a message. This is suffixed to the end of a character string to be transmitted. (Excluding BCC)

4. Operating procedures

Useful functions (RS485 communication function)

⑦ BCC

This is a check code for error detection and is an exclusive OR (EX-OR) of all characters from STX to ETX. This code (BCC) will not be embedded in a reply message when the item BCC check for communication setting is set to "None".

⑧ ACK

This is an acknowledgement code and is returned embedded in a "reply message" from the Unit when the message received with the Unit contains no error.

⑨ NAK

This is a negative acknowledgement code and is returned embedded in a "reply message" from the Unit when the "request message" received with the Unit contains an error.

⑩ ERR type

When a "request message" received with the Unit contains an error, its description is embedded after "⑨NAK" in the "reply message" from the Unit.

This is a communication error and its detailed expression is omitted here.

Reception timeout means a case STX is not sent from the Unit after some response wait time after a host PC has sent BCC.

4. Operating procedures

Useful functions (RS485 communication function)

5. Communication example

5.1 Communication example to be read out

Example) Request message: This message requests read-out of PV to the Unit addressed to address02.

Reply message from the Unit to this: PV data (00123) is returned.

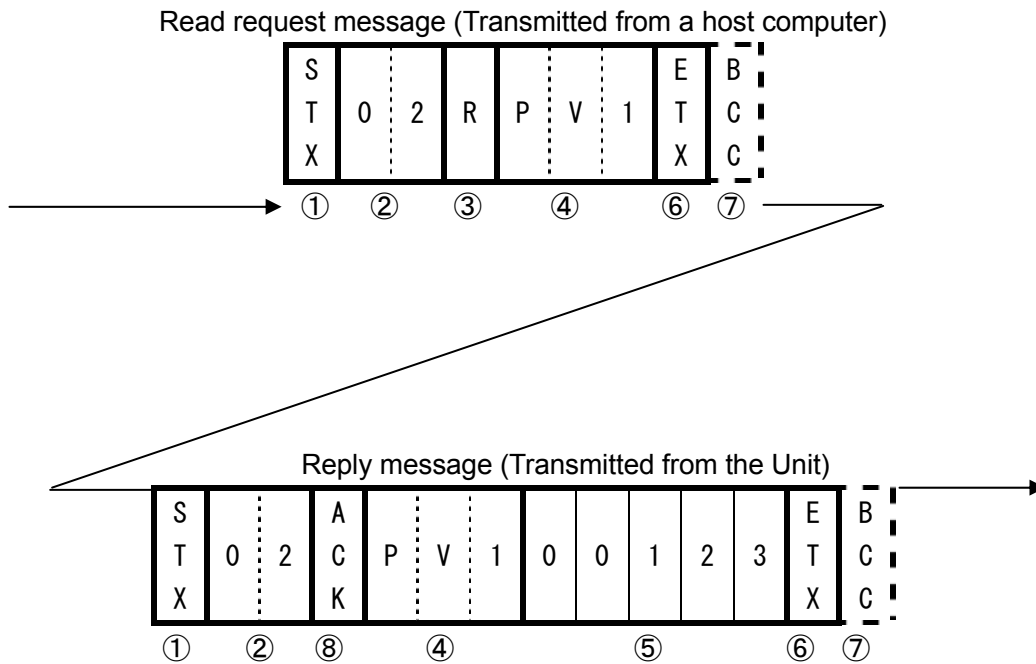

Code	Symbol/data	ASCII code note 2)
① Start code	STX	02H
② Address	02	30H 32H
③ Request (Read)	R	52H
④ Identifier note 1)	PV1	50H 56H 31H
⑤ Numeric data	00123	30H 30H 31H 32H 33H
⑥ End code	ETX	03H
⑦ BCC data Request		61H
Reply		02H
⑧ Acknowledgement code	ACK	06H

Note 1) See "7.Identifier/command list".

Note 2) For ASCII codes, see "8.ASCII code list".

4. Operating procedures

Useful functions (RS485 communication function)

5.2 Example of write communication

Example) Request message: This message requests the Unit addressed to address03 to set "SV setting to 135" (write 135).

Reply message from the Unit to this: Returns acknowledgement that the request message was received.

☆Check that the message has been correctly written by separately reading out the data.

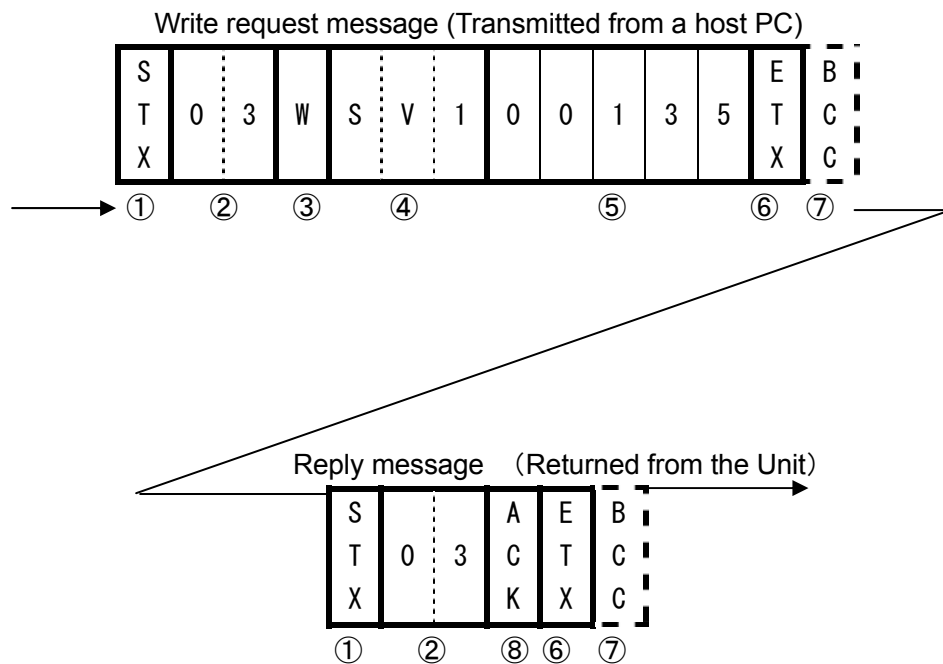

Code	Symbol · data	ASCII code note2)
① Start code	STX	02H
② Address	03	30H 33H
③ Request (Write)	W	57H
④ Identifier note 1)	SV1	53H 56H 31H
⑤ Numeric data	00135	30H 30H 31H 33H 35H
⑥ End code	ETX	03H
⑦ BCC data	Request	56H
	Reply	04H
⑧ Acknowledgement code	ACK	06H

Note 1) See "7.Identifier/command list".

Note 2) For ASCII codes, see "8.ASCII code list".

4. Operating procedures

Useful functions (RS485 communication function)

6. Wire connection

Shown below is an example of the multi drop connection.

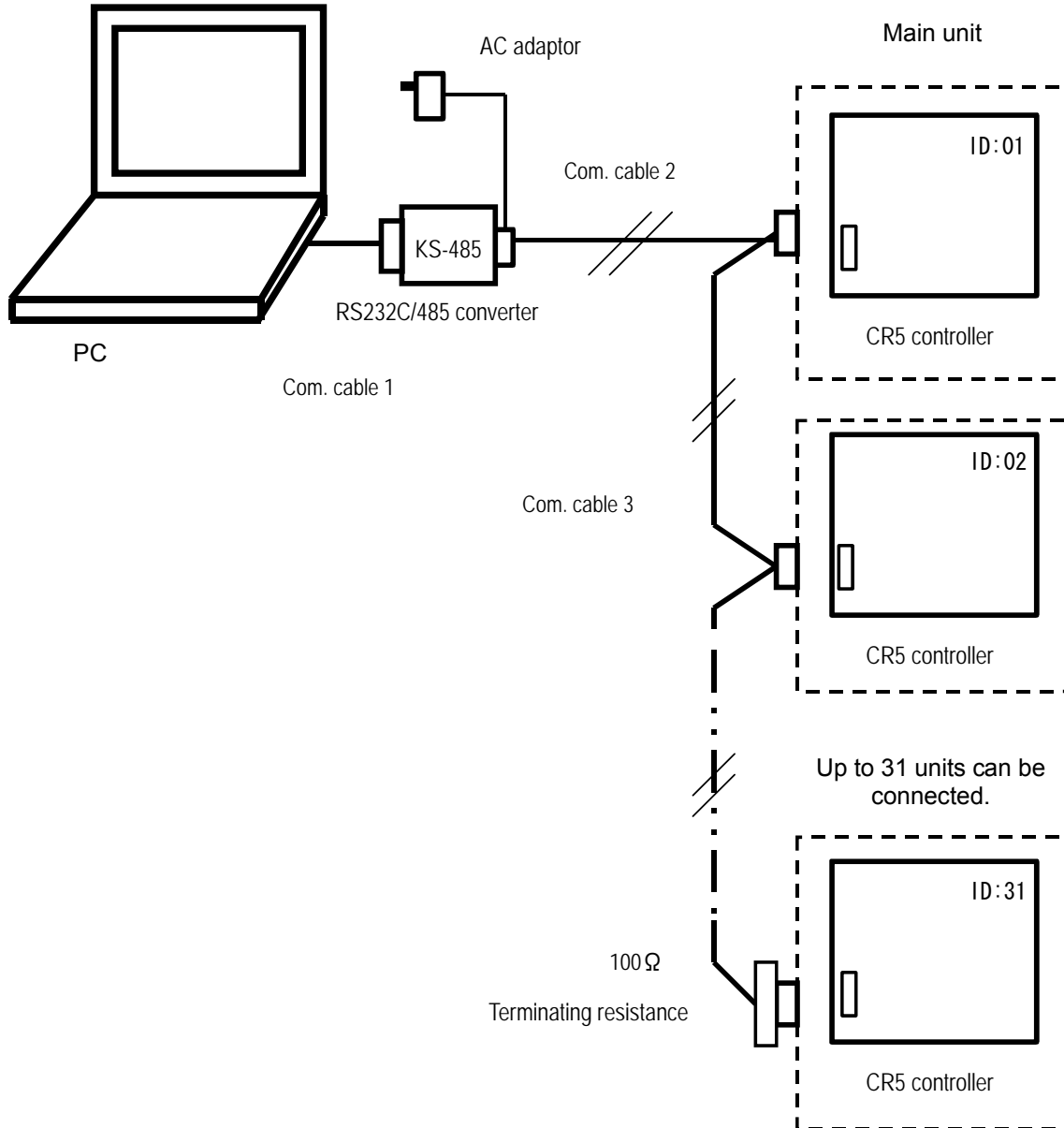

Note1) Com. cable 1: PC side connector (for connecting IBM9 pin device) RS-232C cable 1m, KS-485 side connector (Dsub25 pin, male) System Sacom CBL16

Note2) Com cables 2, 3: These must be separately ordered.

Note3) Terminating resistance: This must be separately ordered. If the customer prepares this, be sure to connect a fixed resistor of at least 100 Ω 1/4W to the final cable device terminal block.

4. Operating procedures

Useful functions (RS485 communication function)

7. Identifier / command list

<About identifiers and settings>

- *1 : When the time exceeds 100 hours, setting unit will be one hour.
- *2 : _ indicates a space.
- *3 : Parameters for which W command is effective during each operation mode. (This is effective during start phase in the normal mode.)

Fixed Temp. operation parameters

Name	Identifier	Command	Setting
Temp. setting	SV1	R/W/**	SLL~SLH : Lower limiter~upper limiter°C *3
Event output setting (Optional)	EVE	R/W/**	00000 : Event output OFF 00001~00015 : 1~15 patterns
Motor output setting	FAN	R/W/**	For motor output operation selection, (Optional) When level control is selected 00001~00010 : Levels 1~10

Program operation parameters

Name	Identifier	Command	Setting
Temp. setting	S01~S99	R/W/**	SLL~SLH : Upper limiter~lower limiter°C *1*2
Time setting	T01~T99	R/W/**	00000~09959 : 0hr 0min~99 hrs 59min H0000~H9999 : 100hrs ~9999hrs
Repeat dest in. setting	R01~R99	R/W/**	00001~00099 : Steps 1~99
Repeat number setting	C01~C99	R/W/**	00000 : None 00001~00099 : 1~99 times 00100 : No restriction
End operation setting	O01~O99	R/W/**	00000 : END status 00001 : HLD status 00100 : FT status
Pattern No. setting	PSN	R/W/**	00001~00099 : Programs 1~99
No of step setting	STC	R/W/**	00000 : No steps (unregistered) 00001~00099 : Steps 1~99
Program No. select	PSP	R/W/**	00000 : Program 1 00001 : Program 2 00100 : Program 3

4. Operating procedures

Useful functions (RS485 communication function)

Program operation parameters

Name	Identifier	Command	Setting
Step No. select	STN	RW/**	00001~00099 : Steps 1~99
Motor output	F01~F99	RW/**	In motor output operation selection, (Optional) When level control is selected 00001~00010 : Levels 1~10

Auto Start operation parameter

Name	Identifier	Command	Setting
Auto Start time setting	SST	RW/**	When time control is selected 00000~09959 : 0hr 0min~99hr 59min *1 H0100~H9999 : 100hrs~9999hrs
			When time control is selected 00000~02359 : hr 0min~23hrs59min

Auto Stop operation parameter

Name	Identifier	Command	Setting
Auto Stop time setting	SPT	RW/**	When time control is selected 00000~09959 : 0hr 0min~99 hr 59min *1 H0100~H9999 : 100hrs~9999hrs
			When time control is selected 00000~02359 : 0hr 0min~23hrs 59min

Other parameters

Name	Identifier	Command	Setting
Dominical year setting	YAR	RW/**	00000~00099 : 0~99 years
Month setting	MON	RW/**	00001~00012 : 1~12 month
Day setting	DAY	RW/**	00000~00031 : 1~31 day
Hour setting	HOU	RW/**	00001~00012 : 0~23 hour
Minute setting	MIN	RW/**	00001~00012 : 0~59 minute
Power ON/OFF	POW	RW/**	00000 : Power OFF *3 00001 : Power ON
Run/stop	RUN	RW/**	00000 : Stop *3 00001 : Run
Operation mode selection	OKS	RW/**	00000 : Fixed Temp. operation select 00001 : Program operation selection

4. Operating procedures

Useful functions (RS485 communication function)

Other parameters

Name	Identifier	Command	Setting
Timer operation select	TOS	RW/**/*	00000 : No timer operation 00001 : Auto Start operation 00002 : Auto Stop operation
Remaining time monitor	_TI	R/**/*	00000 : Timer up or operation stop *2 00001~09959 : 0hr 1min~99hrs 59min H0100~H9999 : 100hrs~9999hrs
Program No. monitor	_MN	R/**/*	00000 : Program 1 select *2 00001 : Program 2 select H0100 : Program 3 select
Step No. monitor	_ST	R/**/*	00000 : Timer up or operation stop *2 00001~00099 : Steps 1~99
Key lock	KLC	RW/**/*	00000 : Key lock release 00001 : key lock
Output monitor 1	OM1	R/**/*	00000 : 1 st digit=Heater output 2 nd digit=Refrigerator output 3 rd digit=Main output 4 th digit=Alarm output 5 th digit=Buzzer output ※ Output status 0=Output OFF 1=Output ON
Output monitor 2	OM2	R/**/*	00000 : 1 st digit=Event 1 output 2 nd digit=Event 2 output 3 rd digit=Event 3 output or operation output 4 th digit=Event 4 output or timer up output 5 th digit=Motor relay output ※ Output status 0=Output OFF 1=Output ON
Error monitor 1	ER1	R/**/*	00000 : 1 st digit=Sensor error 2 nd digit=Heater short-circuit error 3 rd digit=Heater disconnection error 4 th digit=Stand-alone overheat prevention function error 5 th digit=Refrigerator error ※ Error status 0=No error 1=Error
Error monitor 2	ER2	R/**/*	00000 : 1 st digit=Memory error 2 nd digit=AT error 3 rd digit=Internal com. error 4 th digit=No-load heating error 5 th digit=Door open ※ Error status 0=No error 1=Error

4. Operating procedures

Useful functions (RS485 communication function)

Other parameters

Name	Identifier	Command	Setting
Main measured temperature monitor External measured temperature monitor	PV1 PV2	R/**/*	When input to a thermocouple (Ex) 00100 : 100°C When input to platinum (Ex (Ex) 01000 : 100.0°C When input to both of a thermocouple and platinum HHHHH : Measured temp. over scale LLLLL : Measured temp. under scale

4. Operating procedures

Useful functions (RS485 communication function)

8. ASCII code list

ASCII code	02H	03H	06H	15H						
Symbols used	STX	ETX	ACK	NAK						

ASCII code	30H	31H	32H	33H	34H	35H	36H	37H	38H	39H
Figures used	0	1	2	3	4	5	6	7	8	9

ASCII code	2DH	20H								
Figures used	– Minus	SP Space								

ASCII code	41H	42H	43H	44H	45H	46H	47H	48H	49H	4AH
Char. used	A	B	C	D	E	F	G	H	I	J

ASCII code	4BH	4CH	4DH	4EH	4FH	50H	51H	52H	53H	54H
Char. used	K	L	M	N	O	P	Q	R	S	T

ASCII code	55H	56H	57H	58H	59H	5AH	20H			
Char. used	U	V	W	X	Y	Z	SP Space			

5. Cautions on handling

Warning

1. About handling of flammable or combustible solution

-  The unit is not explosion proof. Take special care for handling specimens that contain on which explosive materials, combustible materials. Flammable or combustible solution will evaporate when left at a room temperature (or at a lower temperature for some types of solutions) and may be ignited and explode from switches, lights and other ignitable sources. Be sure to assure sufficient ventilation when using these materials. See section "13. List of dangerous materials" on page 46.

2. Ban on use/countermeasures when an error occurs

-  If smoke is emerges on the unit or an odd odor is felt, immediately turn the ELB on the main unit off, turn the power supply off and contact your dealer or a Yamato sales office for inspection. Otherwise, a fire or an electrical shock may result. The user shall never attempt to repair the unit to avoid any possible dangers.

3. Do not allow liquid to spill over the unit.

-  Do not allow liquid to spill over the unit. Pay special attention not to allow liquid to enter into the suction and exhaust ports in the side and rear panel of the unit. If liquid is spilt over or into the unit, do not try to operate it any further. Otherwise, an accident, a malfunction, a fire or an electrical shock may result.

4. Do not allow a metal piece to fall into the unit.

-  Do not allow a clip, a staple, a screw or other metal pieces to fall into the unit. Stop operating the unit if a metal piece has dropped into the unit. Otherwise, an accident, a malfunction, a fire or an electrical shock may result.

5. Do not open the cabinet.

-  Do not open panels or covers fixed on the unit, or do not operate the unit with any of those open. Other wise, an accident, a malfunction, or an electrical shock may result.

6. Do not attempt to modify the unit.

-  The user shall never try to modify the unit; other wise, an accident, a malfunction, a fire or an electrical shock may result.

5. Cautions on handling

Caution

1. Do not step on the unit.

-  Do not step on the unit. Otherwise, the unit may trip over or be damaged resulting a personal injury or a malfunction.

2. Do not put or drop an object on the unit.

-  Do not put or drop an object on the unit. Since the unit contains high precision devices, vibrations or shock may cause a malfunction.

3. When a thunder is heard.

-  When a thunder is heard, turn the ELB on the main unit off then turn the main power off immediately. Otherwise, a lightning strike may result and cause a fire.

4. During night and not to be operated for a long period of time.

-  During the night and when you want to stop the unit for a longer period of time, turn the ELB to “off” and pull out the power cord from the power supply.

5. About the exhaust and suction ports

-  The temperature in the bath may not reach the operating temperature when the unit is used with the exhaust and suction ports open. In such a case, use the unit after closing the exhaust and suction ports if possible.

6. About recovery from a power failure

-  When the unit shifts from operating to stop status due to, for example, a power failure and then the power recovers, the unit will automatically return to the status immediately before that failure and resumes operation. If you want to recover manually, make settings again by referring to the H06 Function 2 Power failure compensation setting in the “Operation manual for the Program Controller model CR5”.
Turn the ELB off if you do not want to allow the unit to resume operation by automatic recovery.

7. Do not attempt to do anything other than specified in this operation manual.

-  Do not attempt to do anything other than specified in this operation manual. Otherwise, an unexpected accident may result.

6. Maintenance procedures

Daily inspection/maintenance

Be sure to perform daily inspection and maintenance to assure reliable operation of the unit.

Warning

- Be sure to pull out the power cord unless necessary before trying to do inspection and maintenance works.
- Start these works after the device has returned to the normal temperature.
- Never try to disassemble the unit.

Caution

- Wipe off any dirt with a tightly wrung soft cloth. Never try to clean the unit with benzene, thinner or scouring powder, or rub with a scrubbing brush. Deformation, degradation or discoloration may result.

Every month

Inspect the functions of the ELB.

Test shall be performed with the power cord connected and power is being supplied to the unit.

- First turn the ELB to “off.”
- Then, turn the ELB “on” and press the test button on the device with a ball-point pen to check whether it is turned off to indicate that it is in the normal state.

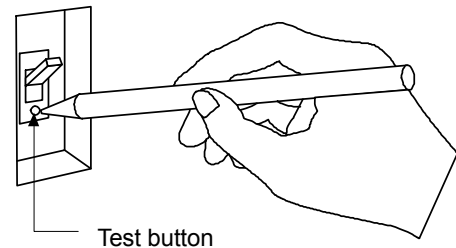

7. When the unit is not to be used for a long time or when disposing

When the unit is not to be used for a long time or when disposing



Caution

When the unit is not going to be used for a long time

- Turn the ELB to off and pull out the power cord.



Warning

When disposing the unit

- Do not leave the unit where children may play around.
- Remove all driving assemblies.
- In general, dispose the unit as a bulky waste.

Notes about disposition

Always pay attention to the preservation of the global environment.

- We highly recommend taking the unit apart as far as possible for separation or recycling to contribute to the preservation of the global environment. Major components and materials for the unit are as follows:

Names of major parts	Major materials
Major components of the main unit	
Outer finish	Bonderized steel sheet, melamine resin baking finish
Internal bath	Stainless steel
Nameplate	Polyethylene (PET) resin film
Heat insulator	Glass wool
Door packing	Silicone rubber (Fluororubber for model V)
Handle	Aluminum die-cast, epoxy melamine resin baking finish
Major electric parts	
Switches and relays	Resin, copper, etc.
Substrates	Glass fiber
Pipe heater	SUS321, others
Power cord	Synthesized rubber covering, copper, and nickel
Wiring materials	Iron, copper, resin, and ceramics
Sensor	SUS304, others
Operation panel	ABS resin, acrylic resin, silicone, others

8. Troubleshooting







Safety device and error codes

The unit has the self diagnostic function with a controller and a separate safety device.

Table below shows possible causes and measures when the safety device is triggered.

[Error codes]

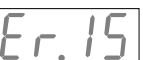
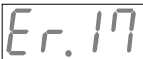
When a functional or mechanical abnormality occurs, operation is stopped, an error code will be displayed on the control panel and the alarm busser will sound. When an abnormality occurs, confirm the error code and immediately stop operation turning the power supply OFF.

Safety device	Symptom	Possible causes and measures
Sensor error	Alarm lamp on  indication	<ul style="list-style-type: none"> ● Error in the temperature input circuit ● Disconnection or other errors in the temperature sensor ● Measured temperature is outside the displayable range Contact our service department.
SSR short circuit	Alarm lamp on  indication	<ul style="list-style-type: none"> ● SSR short circuit Contact our service department.
Detection of heater disconnection Temperature fuse blown out	Alarm lamp on  indication	<ul style="list-style-type: none"> ● Heater disconnection ● Temperature fuse blown out Contact our service department.
Overheat	Alarm lamp on  indication	<ul style="list-style-type: none"> ● Activation of overheat protector First reset the power supply and check the temperature in the bath and the set temperature for the overheat protector. If the unit does not reset, contact our service department.
Memory error	Alarm lamp on  indication	<ul style="list-style-type: none"> ● Memory setting error Contact our service department
Internal communication error	Alarm lamp on  indication	<ul style="list-style-type: none"> ● Communication error between the control board and the display board Contact our service department.
Door switch	 indication	<ul style="list-style-type: none"> ● Door is open. ● Contact the general customer service center if the  indication will not go off even if you close the door.

8. Troubleshooting

When a malfunction is suspected

If any of the symptoms below occurs

Symptom	Check
Turning the ELB to on will not activate the unit.	<ul style="list-style-type: none"> ● If the power cord is connected to the power supply securely. ● If power outage is occurring..
An error code (Er.) is displayed	<ul style="list-style-type: none"> ● Check the error code. Check the error code in “Safety device and error codes” on P.37.
Temperature does not rise.	<ul style="list-style-type: none"> ● If the set temperature is below that in the bath. ● If the power supply voltage has declined. ● If the ambient temperature is outside the usable environmental temperature range. ● If cooling load for inside the bath is large.
Temperature fluctuates during operation.	<ul style="list-style-type: none"> ● If the set temperature is appropriate. ● If the power supply voltage has declined. ● IF fluctuation of the environmental temperature has become large. ● If load for inside the bath is large.

If power outage occurs

When the power is applied again after the unit has stopped due to power outage, the unit will automatically return to the status immediately before the power outage and resumes operation. To manually recover, follow the procedures in H06 FUNCTION 2 “Power failure compensation setting” in the “Operation Manual for the Model CR5 Program Controller”.

Turn the ELB off if you do not want to resume operation by automatic recovery.

- ◆ If the symptom does not match any of the above, immediately turn the ELB on the main unit off, pull out the power cord from the power supply and contact your dealer or one of our sales offices or our support center.

9. After sales service and warranty

When requesting a repair

When requesting a repair

If any trouble occurs, immediately stop operation, turn the ELB off, pull out the power plug and contact your dealer or our sales office.

Information necessary for requesting a repair

- Model name of the product
 - Serial number
 - Date (y/m/d) of purchase
 - Description of trouble (as in detail as possible)
- } See the warranty card or the nameplate on the unit.
} See the section “3. Names and functions of parts” on page 12.

Be sure to indicate the warranty card to our service representative.

Warranty card (attached separately)

- Warranty card is given by your dealer or one of our sales offices and please fill in your dealer, date of purchase and other information and store securely.
- Warranty period is one full year from the date of purchase. Repair service for free is available according to the conditions written on the warranty card.
- For repairs after the warranty period consult your dealer or one of our sales offices. Paid repair service is available on your request when the product's functionality can be maintained by repair.

Minimum holding period of repair parts

The minimum holding period of repair parts for this product is seven years after end of production.

Repair parts here refer to parts necessary for maintaining performance of the product.

10. Specifications

Model		DNE650 (V)	DNE670 (V)	DNE850 (V)
System		Forced convection circulation		
Operating environmental temperature range		5°C~35°C		
Performance	Operating temperature range	Room temperature :+10°C~260°C		
	Temperature control precision	±0.2°C (at 260°C)		
	Temperature distribution precision	±2.0°C (at 260°C)		
	Temperature increase time (~260□)	Approx. 65 min		Approx. 55 min
Configuration	Internal finish	Stainless steel		
	External finish	Bonderized steel plate		
	Heat insulator	Glass wool		
	Temperature/heater control system	PID control/SSR control with a microcomputer		
	Temperature setting/display system	Digital setting/ digital display		
	Sensor	K-thermocouple		
	Heater	Stainless steel pipe heater SUS321		
		120V 1920W	240V 1920W	240V 1730W×2
	Blower fan motor	Sirocco fan condenser motor		
		100V 10W	200V 10W	200V 30W
	Cable port	φ30 (Right side of the outer cas)		
	Suction port	φ30 (Right side of the outer case, internal heater chamber)		
Exhaust port	φ30 manual damper (top back of the outer case)		φ30×2 manual damper (Rear of the outer case)	
Safety functions		Over current ELB, overheat preventive device (in the bath, heater chamber) Self diagnostic function (temperature sensor error, heater disconnection, SSR short-circuit) Automatic overheat prevention (internal controller), temperature fuse, door switch		
Other functions		Key lock function, calibration offset function, external alarm output, temperature output, time-up output, RS485 communication function		
Standards 格	Internal dimensions (W x D x H)	600×500×500 mm		600×500×1000 mm
	External dimensions * (W x D x H)	770×696×995 mm		770×696×1760 mm
	Internal capacity	150L		300L
	Number of shelf stages	13 stages		29 stages
	Shelf peg pitch	30 mm		
	Withhold load of the shelf board	15 kg/board		
	Power supply (50/60Hz)	AC100V~120V	AC200V~240V	
		14~16.5A	7~8.5A	12.5~15A
Weight	Approx.90 kg	Approx. 90 kg	Approx. 130 kg	
Accessories	Shelf boards	Stainless steel punched metal		
		2		4
	Shelf pegs	4		8
		Warranty card, manual holder, Operation manual (this document), operation manual for the Program Controller model CR5		

*Protruding parts are excluded.

*Model V is the non-silicone type.

11. Wiring diagram

DNE650 (V)

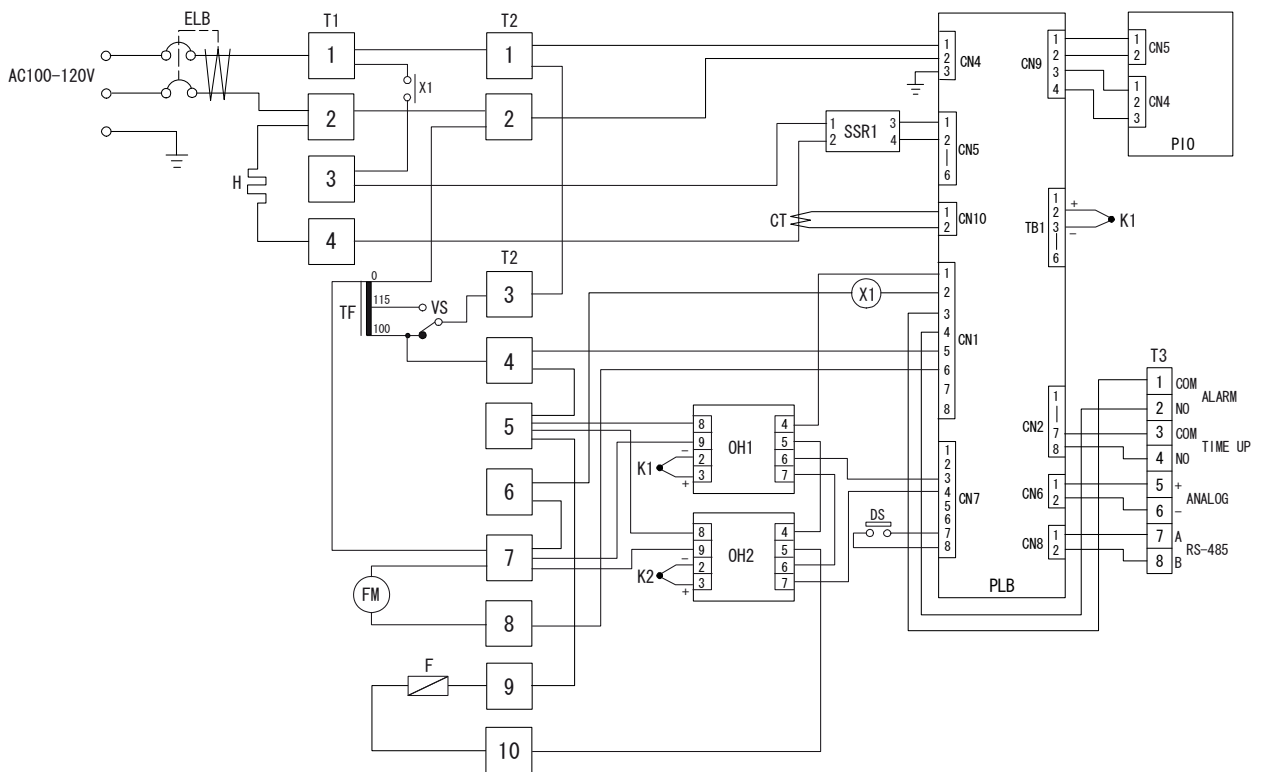

Symbol	Part name	Symbol	Part name
ELB	Electric Leakage Breaker	K1	Temperature sensor (in bath)
T1~3	Terminal block	K2	Temperature sensor (heater)
H	Heater	OH1	Standalone overheat preventive device (in bath)
FM	Fan motor	OH2	Standalone overheat preventive device (heater)
TF	Transformer	SSR1	Solid-state relay
VS	Voltage selector switch	PLB	Planar substrate
X1	Relay	PIO	Display substrate
F	Temperature fuse	CT	Current sensor
DS	Door switch		

11. Wiring diagram

DNE670 (V)

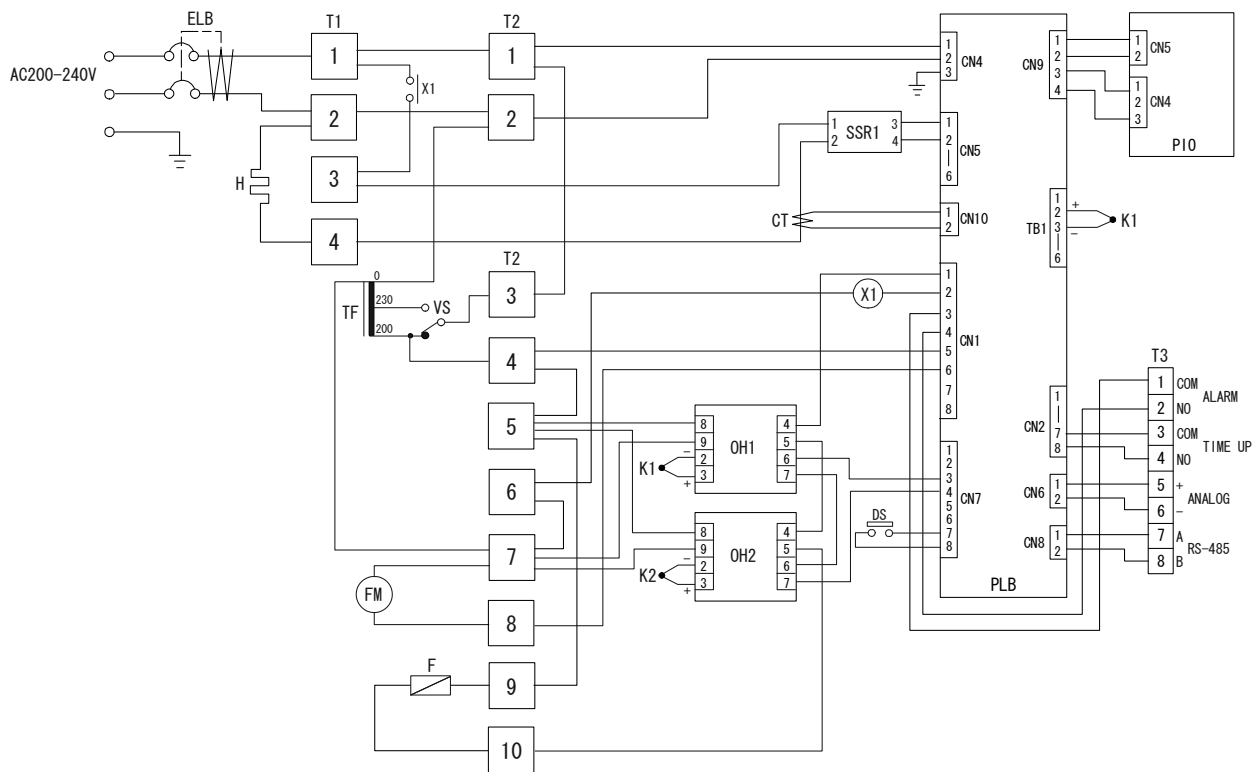

Symbol	Part name	Symbol	Part name
ELB	Electric Leakage Breaker	K1	Temperature sensor (in bath)
T1~3	Terminal block	K2	Temperature sensor (heater)
H	Heater	OH1	Standalone overheat preventive device (in bath)
FM	Fan motor	OH2	Standalone overheat preventive device (heater)
TF	Transformer	SSR1	Solid-state relay
VS	Voltage selector switch	PLB	Planar substrate
X1	Relay	PIO	Display substrate
F	Temperature fuse	CT	Current sensor
DS	Door switch		

11. Wiring diagram

DNE850 (V)

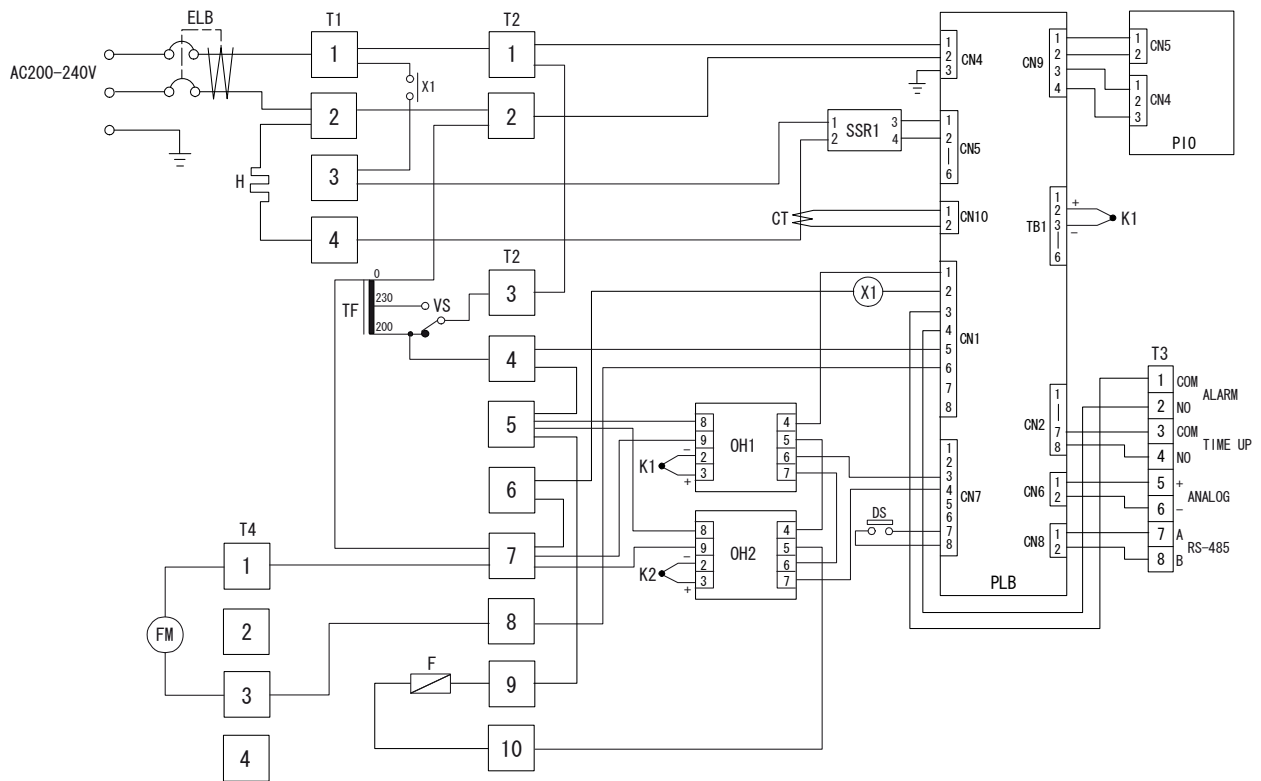

Symbol	Part name	Symbol	Part name
ELB	Electric Leakage Breaker	K1	Temperature sensor (in bath)
T1~4	Terminal block	K2	Temperature sensor (heater)
H1, H2	Heater	OH1	Standalone overheat preventive device (in bath)
FM	Fan motor	OH2	Standalone overheat preventive device (heater)
TF	Transformer	SSR1	Solid-state relay
VS	Voltage selector switch	PLB	Planar substrate
X1	Relay	P10	Display substrate
F	Temperature fuse	CT	Current sensor
DS	Door switch		

12. Replacement parts list

Common parts

Symbol	Part name	Code No.	Specifications	Maker
F	Temperature fuse	LT00018596	C3-15 250V 20A 110°C	Daido
K1	Sensor	LT00018624	K-thermocouple	Nihondensoku
K2	W sensor	LT00018625	K-thermocouple W sensor	Nihondensoku
PLB	Planar board	LT00009410	CR5A	
PIO	Display board	LT00009411	CR5A	
SSR1	Solid atate relay	2160000036	TRS1214	
CT	Current sensor	2170010002	CTL-6-S-4H	Omron
VS	Selection switch	LT00018190	A22S-2M-11	Omron
DS	Lead relay	LT00035254	LAB1(recreation)	Omron
OH1,2	Digital thermostat	2100110002	PAS3K1-0Y0B0Y	Fuji Electric

DNE650 (V)

Symbol	Part name	Code No.	Specifications	Maker	
FM	Motor	2140000031	IC-8422 YAMA	Seishin	
	Sirocco fan	4350010004	S2-158053L-8G	Rokugo	
H	Heater	LT00018623	DNE65_30530	Yamato	
	Door packing	DNE650	LT00033164	DNE65-40791 2.5m	Yamato
		DNE650V	LT00033165	DNE65V-40001 2.5m	
	Power cord	2130010010	T3-3d	Yamato	
ELB	Electric leakage breaker	2060050002	BJS203	Matsushita	
TF	Transformer	LT00018189	UD11-200A2	Toyoden	
X1	Relay	LT00005140	AHE1274	Matsushita	

12. Replacement parts list

DNE670 (V)

Symbol	Part name		Code No.	Specifications	Maker
FM	Motor		2140000033	IC-8422 YAMA	Seishin
	Sirocco fan		4350010004	S2-158053L-8G	Rokugo
H	Heater		LT00018705	DNE67_30000	Yamato
	Door packing	DNE670	LT00033164	DNE65-40791 2.5m	Yamato
		DNE670V	LT00033165	DNE65V-40001 2.5m	
	Power cord		2130010010	T3-3d	Yamato
ELB	Electric leakage breaker		2060050001	BJS153	Matsushita
TF	Transformer		BB519	UD22-200A2	Toyoden
X1	Relay		2050000059	AHE1275	Matsushita

DNE850 (V)

Symbol	Part name		Code No.	Specifications	Maker
FM	Motor		2140000036	IC-8434 YAMA	Seishin
	Sirocco fan		4350010005	S2-178053L-8G	Rokugo
H	Heater		LT00018747	DNE67_30530	Yamato
	Door packing	DNE850	LT00033164	DNE65-40791 3.3m	Yamato
		DNE850V	LT00033165	DNE65V-40001 3.3m	
	Power cord		2130010010	T3-3d	Yamato
ELB	Electric leakage breaker		2060050002	BJS203	Matsushita
TF	Transformer		BB519	UD22-200A2	Toyoden
X1	Relay		2050000059	AHE1275	Matsushita

13. List of dangerous materials



Never use an explosive substance a flammable substance or a substance containing them for this device.

Explosive substance	Explosive substance	① Nitroglycol, glycerine trinitrate, cellulose nitrate and other explosive nitrate esters
		② Trinitrobenzen, trinitrotoluene, picric acid and other explosive nitro compounds
		③ Acetyl hydroperoxide, methyl ethyl ketone peroxide, benzoyl peroxide and other organic peroxides
Flammable substances	Explosive substances	Metal "lithium", metal "potassium", metal "natrium", yellow phosphorus, phosphorus sulfide, red phosphorus, celluloids, calcium carbide (a.k.a, carbide), lime phosphide, magnesium powder, aluminum powder, metal powder other than magnesium and aluminum powder, sodium dithionous acid (a.k.a., hydrosulphite)
	Oxidizing substances	① Potassium chlorate, sodium chlorate, ammonium chlorate, and other chlorates
		② Potassium perchlorate, sodium perchlorate, ammonium perchlorate, and other perchlorates
		③ Potassium peroxide, sodium peroxide, barium peroxide, and other inorganic peroxides
		④ Potassium nitrate, sodium nitrate, ammonium nitrate, and other nitrates
		⑤ Sodium chlorite and other chlorites
		⑥ Calcium hypochlorite and other hypochlorites
	Flammable substances	① Ethyl ether, gasoline, acetaldehyde, propylene chloride, carbon disulfide, and other substances with ignition point at a degree 30 or more degrees below zero.
		② n-hexane, ethylene oxide, acetone, benzene, methyl ethyl ketone and other substances with ignition point between 30 degrees below zero and less than zero.
		③ Methanol, ethanol, xylene, pentyl acetate, (a.k.a.amyl acetate) and other substances with ignition point between zero and less than 30 degrees.
④ Kerosene, light oil, terebinth oil, isopenthyl alcohol(a.k.a. isoamyl alcohol), acetic acid and other substances with ignition point between 30 degrees and less than 65 degrees.		
Combustible gas	Hydrogen, acetylene, ethylene, methane, ethane, propane, butane and other gases combustible at 15°C at one air pressure.	

(Quoted from the separate table 1 in Article 6, the enforcement order of the Industrial Safety and Health Law)

14. Standard installation manual

*Install the product according to the following: (Confirm separately for optional items or special specifications)

Model	Serial number	Date	Installation mgr.(company name)	Installation mgr.	Judgment

No.	Item	Implementation method	TOC No. Reference page of the operating instruction manual	Judgment
Specifications				
1	Accessories	Check for number of accessories on the basis of the column for accessories.	10. Specifications field P.40	
2	Installation	<ul style="list-style-type: none"> Visual check of environmental conditions Caution: Take care for environment 	2. Before operating the unit <ul style="list-style-type: none"> On the installation site P.4	
		<ul style="list-style-type: none"> Securing a space 		
Operation-related matters				
1	Source voltage	<ul style="list-style-type: none"> Measure the user side voltage (outlet, distribution board, etc.) with a tester Measure voltage during operation (shall meet the specifications) Caution: Always use a plug that meets the specification for attaching to the ELB. 	2. Before operating the unit <ul style="list-style-type: none"> Be sure to connect the ground wire. Power supply is 10.Specifications <ul style="list-style-type: none"> Specification-power supply P.6 P.6 P. 40	
2	Operation start	<ul style="list-style-type: none"> Start operation. Perform fixed temp. operation, auto start/auto stop operation 	Refer to the separate "Operation manual for the model CR5 Program Controller".	
Description				
1	Operational descriptions	Explain operations of each component according to the operational instructions	4. Operating procedures <ul style="list-style-type: none"> Operating procedures 1. Safety precautions ~13. List of dangerous materials	Refer to separate manual. P. 1 ~P.46
2	Error codes	Explain the customer about error codes and procedures for release according to the operational instructions	8. Troubleshooting ~9. After sales service and warranty	P.37~39
3	Maintenance and inspection	Explain operations of each component according to the operational instructions	6. Maintenance procedures <ul style="list-style-type: none"> Daily inspection/maintenance 	P. 35
4	Completion of installation Entries	<ul style="list-style-type: none"> Fill in the installation date and the installation mgr. on the nameplate of the main unit Fill in necessary information to the warranty card and hand it over to the customer Explanation of the route for after-sales service 	9. After sales service and warranty	P. 39

Limited liability

Be sure to use the unit strictly following the handling and operating instructions in this operating instruction.

Yamato Scientific Co., Ltd. assumes no responsibility for an accident or a malfunction caused by use of this product in any way not specified in this operating instruction.

Never attempt to perform matters prohibited in this operation instruction.

Otherwise, an unexpected accident may result.

Notice

- **Descriptions in this operating instruction are subject to change without notice.**
- **We will replace a manual with a missing page or paging disorder.**

Instruction Manual

Forced Convection Constant Temperature Oven

Model: DNE650/670/850

Model: DNE650V/670V/850V

Second edition July 15, 2009

Revised Mar. 3, 2012

Yamato Scientific Co., Ltd.

〒103-8432

2-1-6, Nihonbashi, Honcho, Chuo-ku,
Tokyo

Customer support center

 Toll free: 0120-405525

<http://www.yamato-net.co.jp>