



Low Constant Temperature Water Bath

Model

BV100/200/300

Instruction Manual

- Second Edition -

- Thank you for purchasing " Low Constant Temperature Water Bath, BV Series" of Yamato Scientific Co., Ltd.
- To use this unit properly, read this "Instruction Manual" thoroughly before using this unit. Keep this instruction manual around this unit for referring at anytime.

⚠ WARNING!

Carefully read and thoroughly understand the important warning items described in this manual before using this unit.

Yamato Scientific Co. LTD.,

This paper has been printed on recycled paper.

Contents

◆ Cautions in Using with Safety	1
• Explanation.....	1
• Table of Illustrated Symbols	2
• Fundamental Matters of “WARNING!” and “CAUTION!”	3
◆ Before Using this unit	4
• Requirements for Installation.....	4
◆ Description and Function of Each Part	7
• Main Unit	7
• Control Panel.....	8
• Characters of Thermo Controller	9
◆ Operation Method	10
• Preparation.....	10
• Operation Mode and Function List	11
• Operation Mode, Function Setting Key, and Characters	13
• Setting of Overheating Prevention Device	14
• Fixed Temperature Operation.....	15
• Quick Auto Stop Operation	16
• Auto Stop Operation	17
• Auto Start Operation.....	19
• Program Operation.....	21
• How to Program	22
• Program Operation.....	23
• Other Functions.....	29
◆ Handling Precautions	30
◆ Maintenance Method	32
• Daily Inspection and Maintenance	32
◆ Long storage and disposal	33
• When not using this unit for long term / When disposing	33
◆ In the Event of Failure	34
• Error Display.....	34
◆ After Service and Warranty	36
◆ Specification	37
◆ Wiring Diagram	39
◆ Replacement Parts Table	40
◆ Reference	41
• List of Dangerous Substances	41

Explanation

MEANING OF ILLUSTRATED SYMBOLS

Illustrated Symbols

Various symbols are used in this safety manual in order to use the unit without danger of injury and damage of the unit. A list of problems caused by ignoring the warnings and improper handling is divided as shown below. Be sure that you understand the warnings and cautions in this manual before operating the unit.

 **WARNING!** If the warning is ignored, there is the danger of a problem that may cause a serious accident or even fatality.

 **CAUTION!** If the caution is ignored, there is the danger of a problem that may cause injury/damage to property or the unit itself.

Meaning of Symbols



This symbol indicates items that urge the warning (including the caution). A detailed warning message is shown adjacent to the symbol.



This symbol indicates items that are strictly prohibited. A detailed message is shown adjacent to the symbol with specific actions not to perform.



This symbol indicates items that should be always performed. A detailed message with instructions is shown adjacent to the symbol.

Cautions in Using with Safety

Table of Illustrated Symbols

Warning



Warning,
generally

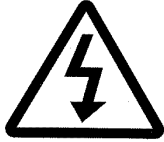

Warning,
high voltage



Warning,
high temperature



Warning,
drive train



Warning,
explosive

Caution



Caution,
generally



Caution,
electrical shock



Caution,
scald



Caution,
no road heating



Caution,
not to drench



Caution,
water only



Caution,
deadly poison

Prohibit



Prohibit,
generally



Prohibit,
inflammable



Prohibit,
to disassemble



Prohibit,
to touch

Compulsion



Compulsion,
generally



Compulsion,
connect to the
grounding
terminal



Compulsion,
install on a flat
surface



Compulsion,
disconnect the
power plug



Compulsion,
periodical
inspection

Cautions in Using with Safety

Fundamental Matters of “WARNING!” and “CAUTION!”

WARNING!

Do not use this unit in an area where there is flammable or explosive gas

Never use this unit in an area where there is flammable or explosive gas. This unit is not explosion-proof. An arc may be generated when the power switch is turned on or off, and fire/explosion may result. (Refer to page41 “List of Dangerous Substances”.)

Always ground this unit

Always ground this unit on the power equipment side in order to avoid electrical shock due to a power surge.

If a problem occurs

If smoke or strange odor should come out of this unit for some reason, turn off the power key right away, and then turn off the circuit breaker and the main power. Immediately contact a service technician for inspection. If this procedure is not followed, fire or electrical shock may result. Never perform repair work yourself, since it is dangerous and not recommended.

Do not use the power cord if it is bundled or tangled

Do not use the power cord if it is bundled or tangled. If it is used in this manner, it can overheat and fire may be caused.

Do not process, bend, wring, or stretch the power cord forcibly

Do not process, bend, wring, or stretch the power cord forcibly. Fire or electrical shock may result.

Substances that can not be used

Never use explosive substances, flammable substances and substances that include explosive or flammable ingredients in this unit. Explosion or fire may occur.

Do not disassemble or modify this unit

Do not disassemble or modify this unit. Fire or electrical shock or failure may be caused.

Do not touch high-temperature parts

The inside of the body or the door may become hot during and just after operation. It may cause burns.

CAUTION!

During a thunder storm

During a thunderstorm, turn off the power key immediately, then turn off the circuit breaker and the main power. If this procedure is not followed, fire or electrical shock may be caused.

Requirements for Installation

WARNING!

1. Always ground this unit



- Connect the power plug to a receptacle with grounding connectors.



- Do not forget to ground this unit, to protect you and the unit from electrical shock in case of power surge. Choose a receptacle with grounding connectors as often as possible.
- Do not connect the grounding wire to a gas pipe, or by means of a lightning rod or telephone line. A fire or electrical shock will occur.
- Though BV300 model is the 100V single phase model, this model has the large electric capacity (over 18A). Be sure to prepare the power switchboard with the specific grand earth or specific receptacle which has electric capacity over 30A.

2. Choose a proper place for installation



- Do not install this unit in a place where:
 - ◆ Rough or dirty surface.
 - ◆ Flammable gas or corrosive gas is generated.
 - ◆ Ambient temperature exceeds 35°C.
 - ◆ Ambient temperature fluctuates violently.
 - ◆ There is direct sunlight.
 - ◆ There is excessive humidity and dust.
 - ◆ There is a constant vibration.



- Install this unit on a stable place with the space as shown below. This unit should be installed horizontally by using adjusters on the four corners.

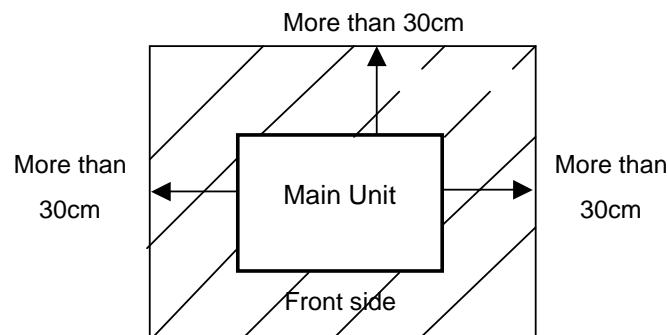

Requirements for Installation

3. Do not use this unit in an area where there is flammable or explosive gas



- Never use this unit in an area where there is flammable or explosive gas. This unit is not explosion-proof. An arc may be generated when the power switch is turned ON or OFF, and fire/explosion may result. (To know about flammable or explosive gas, refer to page41 “List of Dangerous Substances”.)

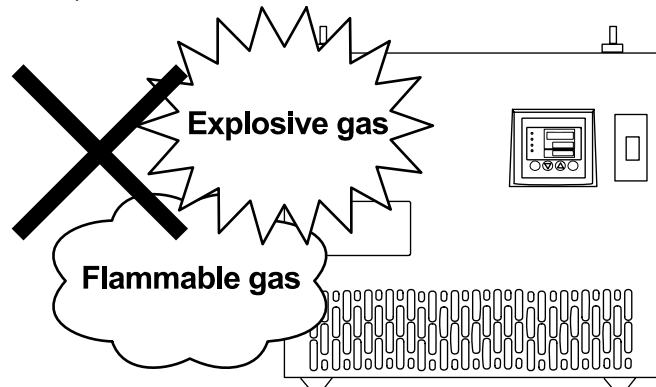

4. Do not modify



- Modification of this unit is strictly prohibited. This could cause a failure.

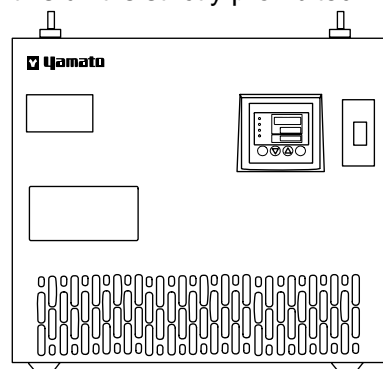

5. Installation on horizontal surface



- Set this unit to the flattest place. Setting this unit to sloping or uneven place could cause the vibration or noise, or cause the unexpected trouble or malfunction.

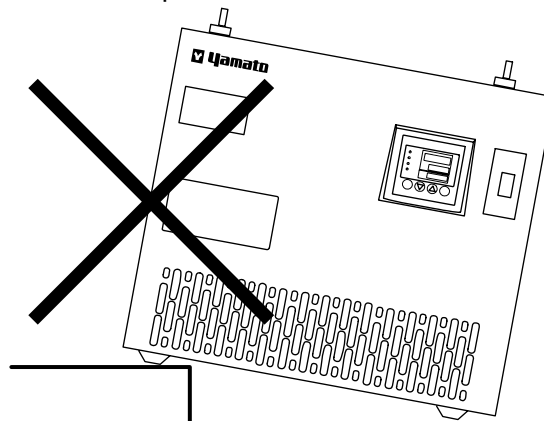

Requirements for Installation

CAUTION!

6. Choose a correct power distribution board or receptacle



- Choose a correct power distribution board or receptacle that meets the unit's rated electric capacity.

Electric capacity: BV100: AC100 V, 10A
 BV200: AC100 V, 14A
 BV300: AC100 V, 18A

NOTE)

There could be the case that the unit does not run even after turning ON the power. Inspect whether the voltage of the main power is lowered than the specified value, or whether other device(s) uses the same power line of this unit. If the phenomena might be found, change the power line of this unit to the other power line.

7. Before/after installing



- It may cause injure to a person if this unit falls down or moves by the earthquake and the impact. etc..To prevent, take measures that the unit cannot fall down, and not install to busy place.

8. Handling of power code



- Do not entangle the power cord. This will cause overheating and possibly a fire.
- Do not bend or twist the power cord, or apply excessive tension to it. This may cause a fire and electrical shock.
- Do not lay the power cord under a desk or chair, and do not allow it to be pinched in order to prevent it from being damaged and to avoid a fire or electrical shock.
- Keep the power cord away from any heating equipment such as a room heater. The cord's insulation may melt and cause a fire or electrical shock.



- If the power cord becomes damaged (wiring exposed, breakage, etc.), immediately turn off the power at the rear of this unit and shut off the main supply power. Then contact your nearest dealer for replacement of the power cord. Leaving it may cause a fire or electrical shock.
- Connect the power plug to the outlet which is supplied appropriate power and voltage.

Description and Function of Each Part

Main Unit

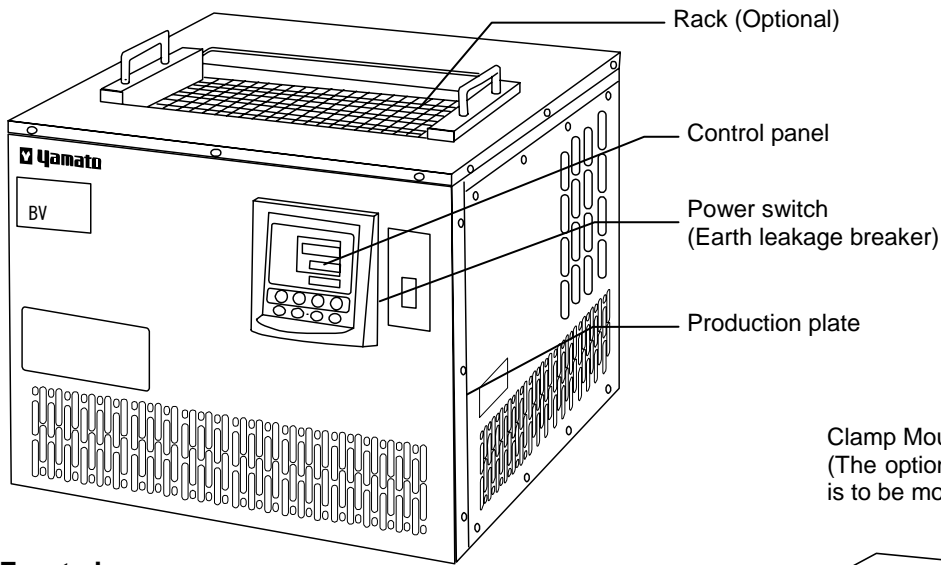

Front view

Rear view

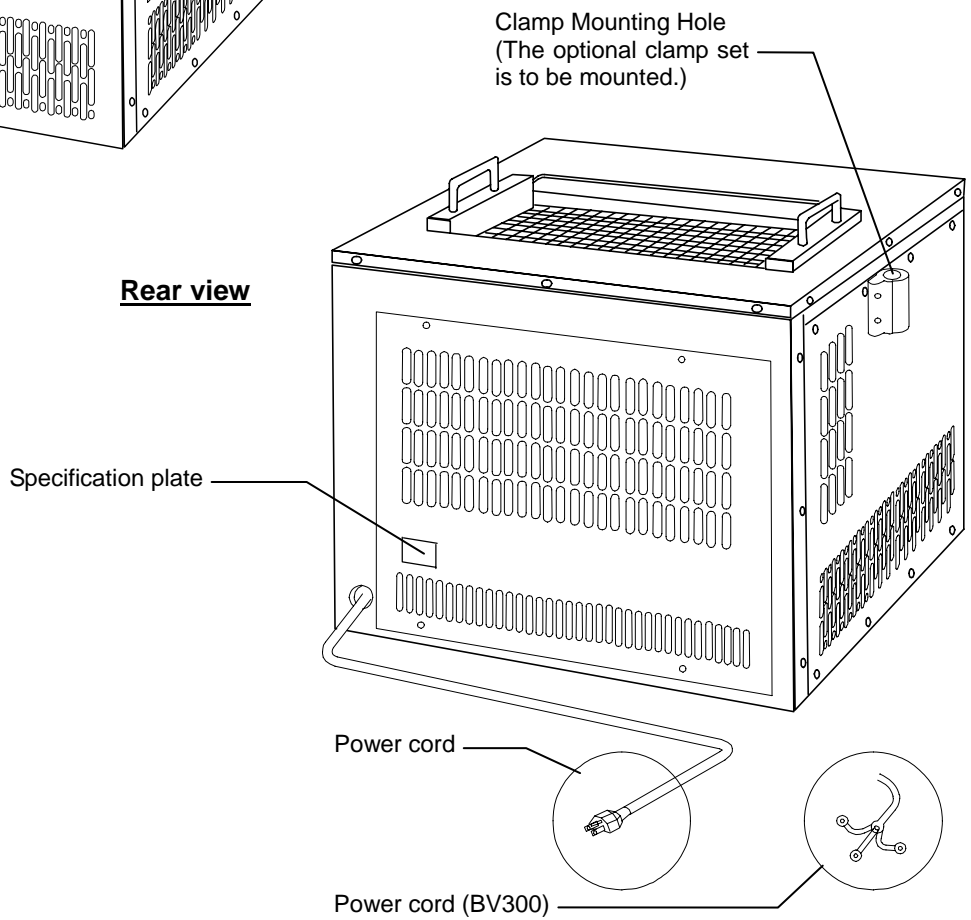

Accessory

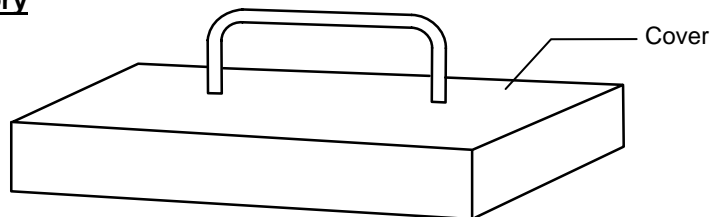

Description and Function of Each Part



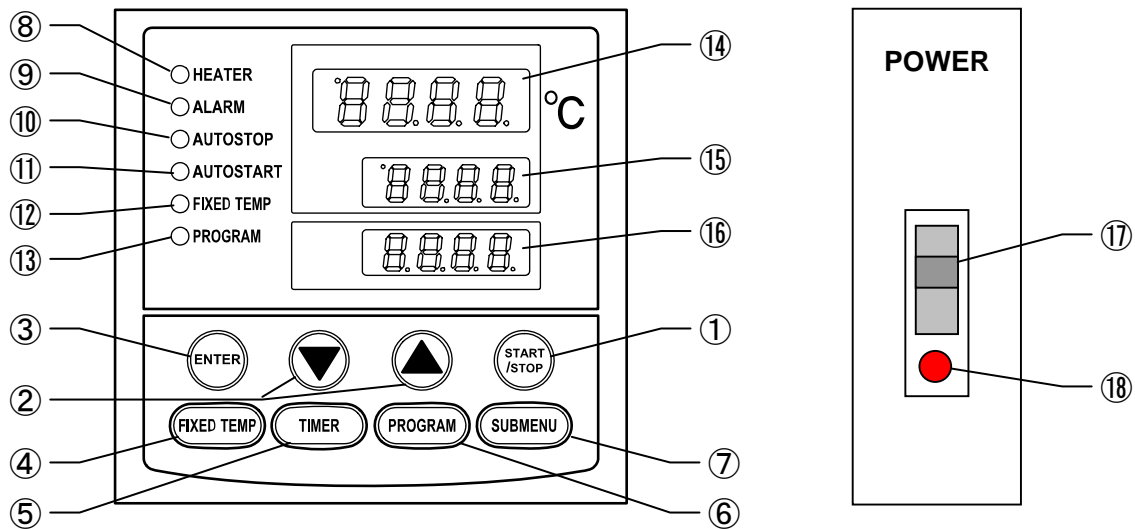









Control Panel

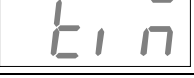

①	START/STOP Key :	Starts/stops the operation.
②	▲▼ Key :	Uses for rising UP/lowering DOWN the setting value.
③	ENTER Key :	Settles the inputted value.
④	FIXED TEMP Key :	Chooses the fixed temperature operation.
⑤	TIMER Key :	Chooses the timer operation (Quick Auto Stop/Auto Stop/Auto Start).
⑥	PROGRAM Key :	Chooses the program operation or program creation mode.
⑦	SUBMENU Key :	Uses for setting the overheating prevention temperature, calibration offset temperature, key lock function, or program repeat function.
⑧	HEATER Lamp :	Lights while the heater works.
⑨	ALARM Lamp :	Lights up when an error occurs. (Buzzer sounds simultaneously.)
⑩	AUTO STOP Lamp :	Blinks while setting quick auto stop timer or auto stop timer. Lights while quick auto stop timer or auto stop timer is running.
⑪	AUTO START Lamp :	Blinks while setting auto start timer. Lights while auto start timer is running.
⑫	FIXED TEMP Lamp :	Blinks while setting fixed temperature operation. Lights while fixed temperature operation is running.
⑬	PROGRAM Lamp :	Blinks while setting program operation. Lights while program operation is running.
⑭	Measurement Temperature Display :	Displays the measured temperature, setting character, alarm information.
⑮	Setting Temperature Display :	Displays the setting temperature, setting value for timer mode, remaining time.
⑯	Overheating Prevention Temperature Display :	Displays the setting temperature for overheating prevention device.
⑰	Power Switch : (Earth leakage breaker)	Turns ON/OFF the main power.
⑱	Electric leak testing button :	Checks the breaker's condition.

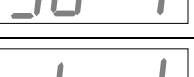
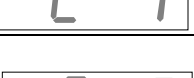
Description and Function of Each Part

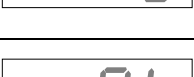
Characters of Thermo Controller

Character	Identifier	Name	Purpose
	FiX	Fixed Temperature Setting Mode	Used for starting the fixed temperature operation.
	Sv	Temperature Setting	Used for setting the temperature.
	AStP	Timer Setting Mode Display	Represents the setting of quick auto stop or auto stop operation.
	AStr	Timer Setting Mode Display	Represents the setting of auto start operation.
	tim	Time Setting	Used for setting the time.
	PrG3	Program Type	Used for choosing program type from 1 to 3. (Refer to Page 21 " Program Operation".)
	PAt	Program Pattern	Used for choosing program pattern. (Refer to Page 21 " Program Operation".)
	End	Time Up	Displays when the timer operation is completed or while inputting number of program steps. (Refer to Page 21 " Program Operation".)
	Sv-1	Program Temperature Setting	Used for setting the temperature for each step in the program. (Sv-1 to Sv-30 is shown.)
	t-1	Program Time Setting	Used for setting the time for each step in the program. (t-1 to t-30 is shown.)
	PS-3	Step Number to be Repeated	Used for choosing the step number to be repeated under the program operation with repeat function. (Refer to Page 26 " Use program repeat function".)
	Pc-2	Repeating Times	Used for setting the repeating times under the program operation with repeat function. (Refer to Page 26 " Use program repeat function".)
	cAL	Calibration Offset Setting	Used for inputting the calibration offset temperature. (Refer to Page 29 "Other Function".)
	oH	Overheating Prevention Setting	Used for setting temperature for overheating prevention device. (Refer to Page 14 "Setting of Overheating Prevention Device ".)
	Lock	Key Lock	Locks the keys on control panel to protect from unnecessary operation. (Refer to Page 29 "Other Function".)

* Also refer to Page 13 "Operation Mode, Function Setting Key, and Characters".

Preparation

Water to be Applied

- If this unit is operated in the environment with its temperature 5°C or under, apply the aqueous [water] solution including 10% ethanol.
- If applying water in such an environment, the water might be frozen with the device temperature set at 0°C, and cause the malfunction. Never freeze the water.
- Apply the aqueous [water] solution including ethyl alcohol according to the following table.
- Never apply the fluid such as antifreeze solution for automobile or ethylenrglycol to this unit.

Ethanol Density		Freezing Point
Wt %	Vo1 %	(°C)
4.8	6.0	-2.0
11.3	14.0	-5.0

NOTE)

The alcohol is the volatile liquid. When using the alcohol, refill the alcohol as required every operation, or replace to new one.

Keep the Appropriate Water Level

Keep the water level 30mm (guideline value) under the top cover of the water bath as the appropriate water level of this unit.

Cooling Capacity

The time requiring for cooling the 20°C water temperature down to 0°C is around 3 hours. However this time differs depending on the outside temperature.

Cooling Device Performance

- This unit is applied the peltier element for the cooling device.
- The cooling device turns ON at 40°C or less and turns OFF over 40°C automatically.
- While the cooling device activates, the LED on the top left of the measurement temperature display window is lit.

NOTE)

If the temperature of the device is set under 40°C after operating with it temperature over 40°C, the cooling device does not activate until the temperature of the water bath be cooled down till 40°C.

Operation Mode and Function List

All the operation mode of this unit is as follows;

No.	Name	Description	Page
1.	Fixed Temperature Operation	Pressing the FIXED TEMP key enters into the fixed temperature operation setting mode. Pressing it again enters into the temperature setting mode. The "▲▼" are used to set temperature. Pressing the START/STOP key starts or stops operation.	15
2.	Quick Auto Stop Operation	This operation is used to specify the period up to automatic stop during operation. The period up to operation stop can be set by pressing the TIMER key during fixed temperature operation. The "▲▼" are used to set the time. Pressing the START key starts the quick auto stop operation, activates the timer function and stops the operation automatically after specified period.	16
3.	Auto Stop Operation	This operation is used to specify the automatic stop time in the fixed temperature operation. Pressing the TIMER key displays "AS t p". The setting temperature "SV" can be set by pressing the ENTER key. The operation time "tim" can be set by pressing it again. Pressing the START/STOP key starts the auto stop operation.	17
4.	Auto Start Operation	This operation is used to specify the period up to automatic start after power on. Pressing the TIMER key displays "AS t r". The setting temperature "SV" can be set by pressing the ENTER key. The operation time "tim" can be set by pressing it again. Pressing the START/STOP key starts the auto start operation.	19
5.	Program Operation	This operation is used to change the temperature according to the setting temperature and time. Pressing the PROGRAM key displays "PrG1". Press it again to select the program mode. Press the ENTER key to select the pattern "PA t". Press the ENTER key to display "End". Input the number of patterns to be used. Input the temperature and time of patterns "SV-n" and "t-n" respectively.	21

NOTE) This unit is impossible to be changed the mode during the operation. If the mode requires to be changed, stop the operation.

Operation Mode and Function List

The operation function of this unit is as follows;

No.	Name		Description	Page
1.	Overheating prevention function	Auto overheating prevention function	This function is set to be automatically activated (auto reset) when the temperature exceeds the setting temperature by 6°C.	14
		Overheating prevention device	Though the device shares power source, display, and key input with the controller, it has independent temperature measurement circuit, CPU, sensor and output circuit. Overheating prevention temperature can be set using the operation panel. The unit stops operation when the device is activated. The unit starts operation again when the POWER switch is pressed again (manual reset).	
2.	Calibration offset function		This calibration offset function is for calibrating the difference occurred between the required in-furnace temperature and control temperature (sensor temperature) of the controller. This unit can be calibrated toward either plus side or minus side of the whole temperature range.	29
3.	Overheating prevention temperature calibration function		The temperature of overheating prevention device is automatically corrected when the temperature of controller is collected.	-
4.	Recovery at power failure		The unit starts operation with the same condition as just before power failure if it occurs during operation. Press the START/STOP key to start the unit again.	-
5.	Setting value locking		This function locks the established operation status. It can be set and cancelled with the SUBMENU key.	29

Operation Mode, Function Setting Key, and Characters

The operation mode setting and function setting use the key operation and characters show in the following figure.

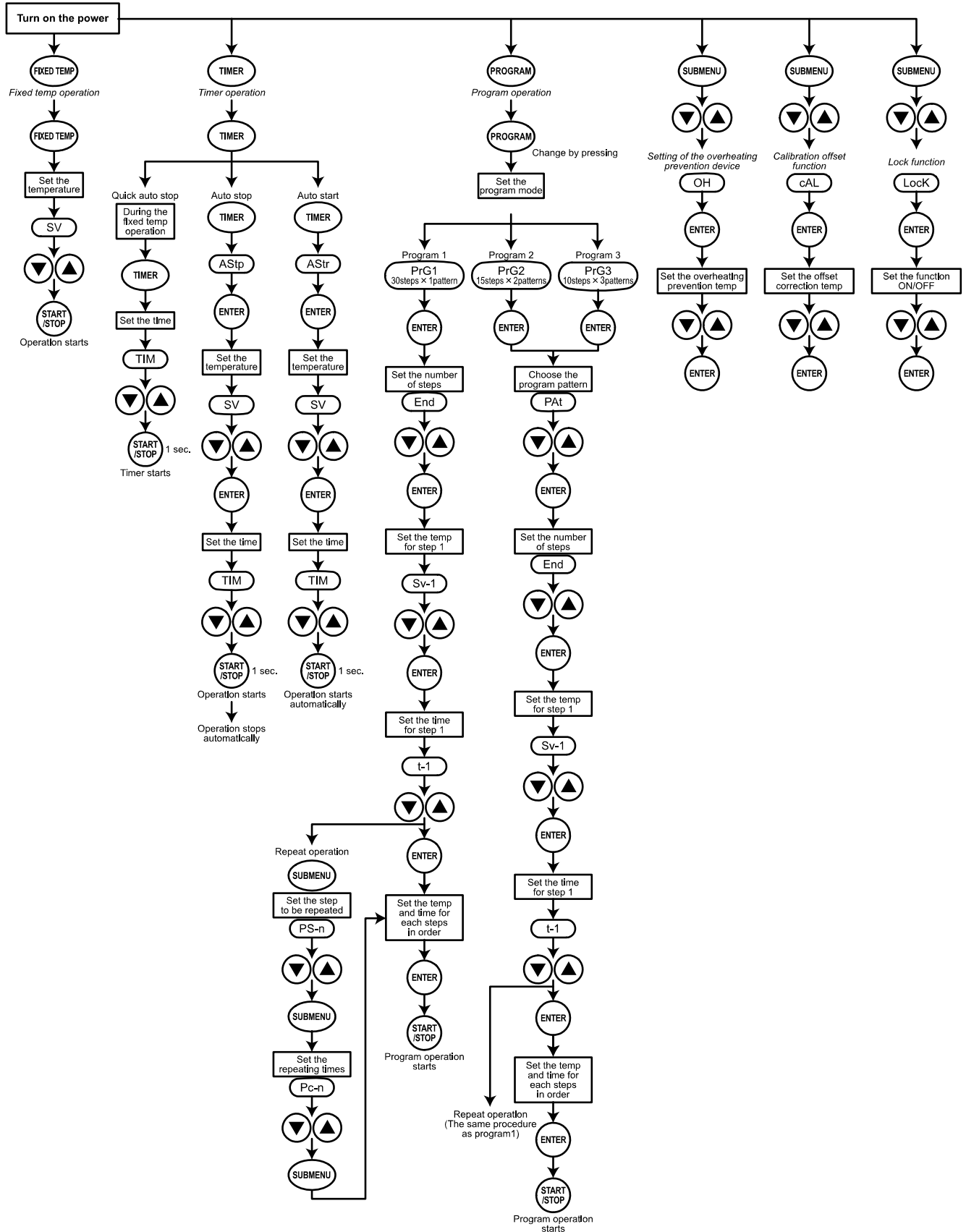

Setting of Overheating Prevention Device

The unit has the overheating prevention device (manual reset) that consists of independent temperature measurement circuit, CPU, sensor and output circuit (it shares power source, display, and key input with the controller) in addition to the automatic overheating prevention function (auto reset) in the controller.

Setting range/function

The unit has failsafe functions against overheating. One of them is built in the controller and previously set at factory shipment so to be automatically activated when the temperature exceeds the setting temperature of temperature controller by 6°C, where the heater repeats on and off.

The other is united with the controller, which can be set by operating the keys on the controller.

The setting range of latter is from 0°C to max set temperature of main controller + 50°C.

In case the temperature in furnace exceeds the setting temperature of controller to reach to that of overheating prevention device, the circuit is shut off and "Er19" is displayed with blinking on the screen of controller with buzzer sound.

If the device is once activated, "Er19" continues to be displayed until the power is newly turned on.

Temperature setting procedure

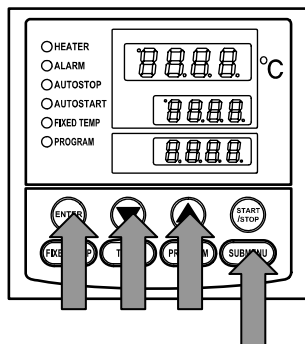

1. Turn on the power (turn on the breaker in front)

- The default value is displayed for about four seconds after turning on the power. The screen then displays the initial setting. The current temperature in furnace, operation mode character and setting temperature of overheating prevention device are displayed on respective screens.

2. Set the temperature for overheating prevention

- Press the SUBMENU key.
- Press the "▼▲" several times to select the setting character of overheating prevention temperature "OH".
- Press the ENTER key. The current setting temperature is displayed with blinking on the setting temperature screen.

Note: To prevent improper operation, set the value 10°C or more over the setting temperature of controller.

- Select the value using the "▼▲" and then press the ENTER key. This completes the setting.

Notes:



- The standard setting temperature of device is "the maximum setting temperature of unit plus 10°C" or "setting temperature plus 10°C". If the unit performs improper operation, increase it 5°C more.
- The setting range of overheating prevention device is from 0°C to max set temperature of main controller + 50°C. Improper setting of temperature may cause inoperative of unit, malfunction of device, e.g. it is activated during increasing in temperature in furnace, or unexpected accidents such as fire disaster. To prevent such matters, set a proper value. **The temperature is set to 90°C at factory shipment. Do not set the value larger than it.**
- In some case, the overheating prevention device is possible to be activated by mistake when its yield temperature is set to around room temperature.
- The purpose of overheating prevention device is to protect the unit from overheating. It does not intend to protect the samples, or to protect them from the accident caused by the use of explosive or inflammability.

Fixed Temperature Operation

Fixed temperature operation procedure

1. Turn on the power (turn on the breaker in front)

- ❖ The default value is displayed for about four seconds after turning on the power. The screen then displays the initial setting. The current temperature in furnace, operation mode character and setting temperature of overheating prevention device are displayed on respective screens.

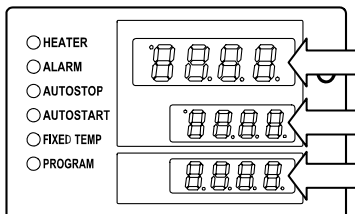

Measurement temperature screen:

Displays the current temperature in furnace.

Setting temperature screen:

Displays the operation mode character. (Refer to Page 13)

Overheating prevention screen:

Displays the setting temperature of overheating prevention device

2. Select the operation mode

- Press the FIXED TEMP key to display "FIX", which indicates the fixed temperature operation, on the center display screen.

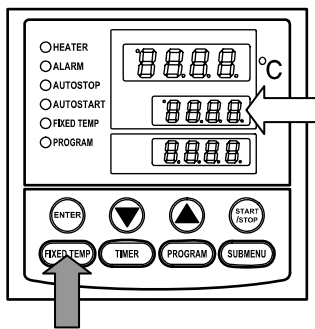

3. Set the temperature

- Press the FIXED TEMP key again.
- The setting temperature screen displays the character "SV" which indicates the temperature setting. Also it displays the current setting temperature with blinking. The FIXED TEMP lamp blinks, too.
- Set the temperature by pressing the "▼▲".

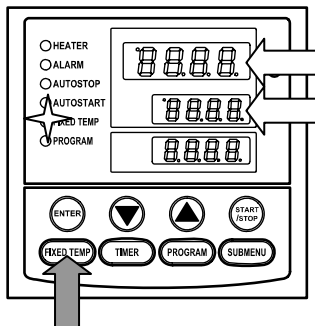

4. Start operation

- Press the orange START/STOP key for about one second. The unit starts operation and the blinking FIXED TEMP lamp lights on.

5. Stop operation

- Press the orange START/STOP key for about one second. The unit stops operation and the FIXED TEMP lamp lights off. The screen returns to the initial setting screen.

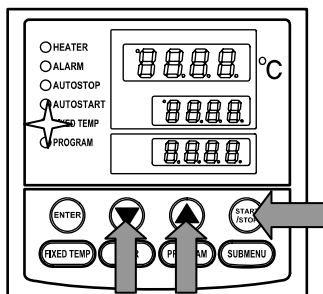

To correct or check setting...

Press the FIXED TEMP key again to correct or check the setting.

Changing the setting temperature during operation is also possible by pressing the FIXED TEMP key.

Quick Auto Stop Operation

Quick auto stop operation procedure

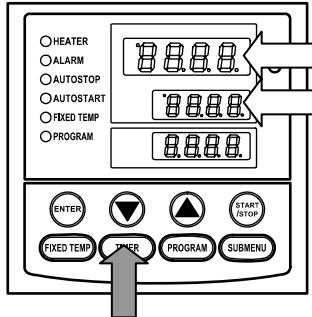

This operation is used to specify the period up to automatic stop, i.e., sets the auto stop timer during operation.

1. Set the time up to stop during fixed temperature operation

- Check that the FIXED TEMP lamp lights on and that the unit is under operation.
- Press the TIMER key.
- The measurement temperature display screen displays the character "tim", which indicates the timer setting. The setting temperature display screen displays the current setting time with blinking.
- Select the time by pressing the "▼▲".

Timer function:

- The maximum setting time is "999 hours and 50 minutes".
- The time can be set in increments of a minute under 99 hours and 59 minutes.
- It can be set in increment of ten minutes over 100 hours.
- The "▼▲" can change the setting time quickly when it is pressed continuously. Press them discontinuously when fine adjustment is needed.

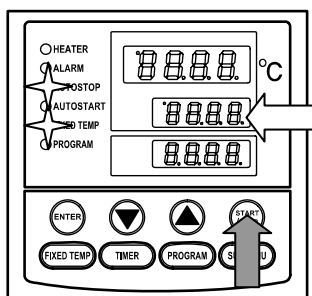

2. Start timer operation

- Press the START/STOP key for one second after deciding the time.
- Timer operation starts with the FIXED TEMP and AUTO STOP lamps lighting on.
- The timer is activated at the point when the START/STOP key is pressed.

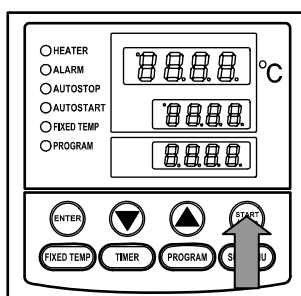

3. Stop/terminate timer operation

- The operation stops automatically at setting time.
- Buzzer continues to sound for about five minutes at operation stop.
- The setting temperature screen displays the character "End", which indicates termination of operation, with the FIXED TEMP and AUTO STOP lamps lighting on. Press the START/STOP key to terminate the timer operation mode. The screen returns to the initial setting screen.

To correct or check setting...

Changing the setting temperature during operation is possible by pressing the FIXED TEMP key. Press the ENTER key after changing the setting.

Changing the setting temperature during operation is available by pressing the FIXED TEMP key. Press the ENTER key after changing the setting.

Press the ▼ key to display the setting temperature, operation mode and residual time on the setting temperature screen.

Auto Stop Operation

Auto stop operation procedure

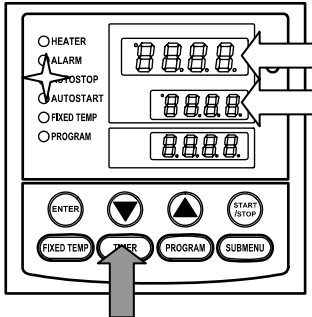

This operation is used to specify the automatic stop time in the fixed temperature operation.

1. Set stop time

- ① Press the TIMER key on the initial screen.
Press the TIMER key again. The setting temperature display screen displays the character "AstP", which indicates the auto stop operation, with blinking.
- ② Press the ENTER key.
The measurement temperature screen displays the character "SV", which indicates the temperature setting. The setting temperature screen displays the current setting temperature with blinking. The AUTO STOP lamp blinks, too.
- ③ Set the temperature using the "▼▲".
- ④ Press the ENTER key again.
The measurement temperature display screen displays the character "tim", which indicates the timer setting. The setting temperature display screen displays the current setting time with blinking.
- ⑤ Set the time using the "▼▲".

Timer function:

- The maximum setting time is "999 hours and 50 minutes".
- The time can be set in increments of a minute under 99 hours and 59 minutes.
- It can be set in increment of ten minutes over 100 hours.
- The "▼▲" can change the setting time quickly when it is pressed continuously. Press them discontinuously when fine adjustment is needed.

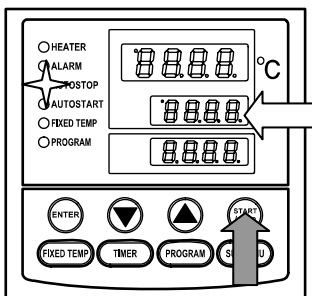

2. Start timer operation

- Press the START/STOP key for one second after deciding the time.
- Timer operation starts with the AUTO STOP lamp lighting on.
- The timer is activated at the point when the temperature in furnace (measurement temperature) reaches to the setting temperature.

Auto Stop Operation

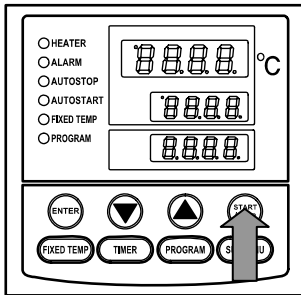

3. Stop/terminate timer operation

- The operation stops automatically at setting time.
- Buzzer continues to sound for about five minutes at operation stop.
- The setting temperature screen displays the character "End", which indicates termination of operation, with the FIXED TEMP and AUTO STOP lamps lighting on. Press the START/STOP key to terminate the timer operation mode. The screen returns to the initial setting screen.

To correct or check setting...

Changing the setting temperature or time during operation is possible by pressing the TIMER key. Use the "▼▲" to change the setting value. Press the ENTER key respectively after changing the setting.

Press the "▼" to display the setting temperature, operation mode and residual time on the setting temperature screen.

Auto Start Operation

Auto start operation procedure

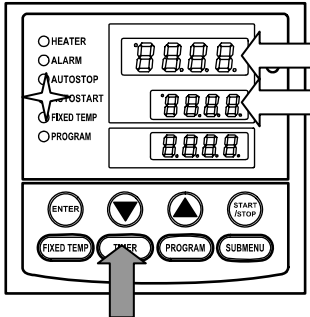

This operation is used to specify the period up to automatic start after power on.

1. Set start time

- ① Press the TIMER key on the initial screen.
Press the TIMER key again. The setting temperature display screen displays the character "Astr", which indicates the auto start operation, with blinking.
- ② Press the ENTER key.
The measurement temperature screen displays the character "SV", which indicates the temperature setting. The setting temperature screen displays the current setting temperature with blinking. The AUTO START lamp blinks, too.
- ③ Set the temperature using the "▼▲".
- ④ Press the ENTER key again.
The measurement temperature display screen displays the character "tim", which indicates the timer setting. The setting temperature display screen displays the current setting time with blinking.
- ⑤ Set the time using the "▼▲".

Timer function:

- The maximum setting time is "999 hours and 50 minutes".
- The time can be set in increments of a minute under 99 hours and 59 minutes.
- It can be set in increment of ten minutes over 100 hours.
- The "▼▲" can change the setting time quickly when it is pressed continuously. Press them discontinuously when fine adjustment is needed.

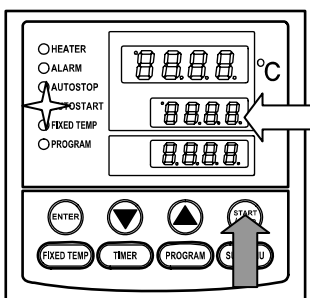

2. Start timer operation

- Press the START/STOP key for one second after deciding the time.
- Timer operation starts with the AUTO START lamp lighting on.

Auto Start Operation

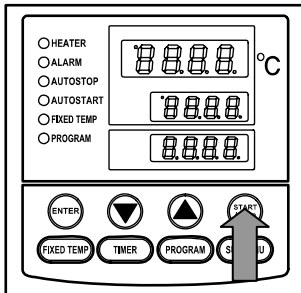

3. Stop/terminate timer operation

- The operation starts automatically at setting time.
- Press the START/STOP key for one second to stop or terminate operation. The screen returns to the initial setting screen.

To correct or check setting...

Changing the setting temperature or time during operation is possible by pressing the TIMER key. Use the "▼▲" to change the setting value. Press the ENTER key respectively after changing the setting. They are not changeable after the unit starts operation. In this case, stop the operation by pressing the START/STOP key, then set the value again.

Press the "▼" to display the setting temperature, operation mode and residual time on the setting temperature screen.

Program Operation

This operation is used to change the temperature according to the setting temperature and time.

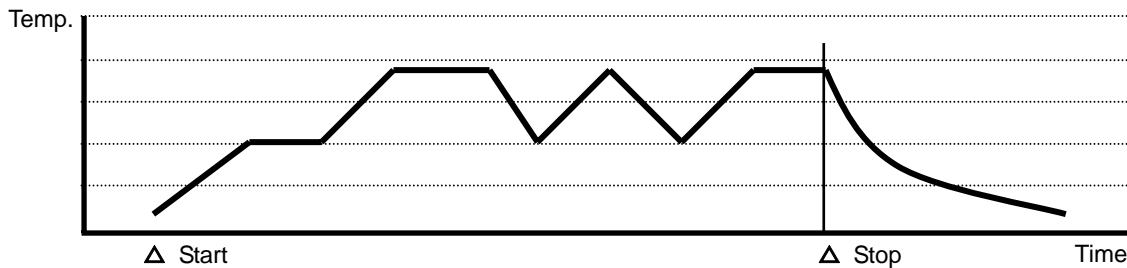

Program types

Six patterns of program types maximum can be input.

PrG1	-	1 program pattern using 30 steps maximum can be created.
PrG2	PA1	2 program patterns using 15 steps maximum can be created.
	PA2	
PrG3	PA1	3 program patterns using 10 steps maximum can be created.
	PA2	
	PA3	

Before inputting program...

Input program patterns before program operation.

- ① Check the number of steps in a created program and their setting temperature/time. Use the program preparation sheet in pages 29 and 30 to check.
- ② Check the temperature rise/fall capability of the unit. Set the time within the capability above. Suppose, for instance, that in the unit which has capability of increasing or decreasing temperature by 50°C within 30 minutes, about 30 minutes is needed to increase or decrease temperature by 100°C from current temperature

Repeat function:

Repeat function is useful in case the operation uses the program repeating the same program steps. Refer to page 26 for the function.

- ③ Check if the controller has sufficient free pattern for the number of steps to be created. The steps, however, using the repeat function mentioned above are not counted.

How to Program

1. Temperature Rising/Falling Time of BV Model

BV Model is required to set the time of the temperature inclination within the temperature rising/falling capacity of BV Model.

Following table shows the actual data of the temperature rising/falling time of each model.



Note that the value shown in the table above is used as the reference value, for the value is changed depending on the following conditions, quantity of sample, water temperature, ambient temperature, etc.

1) Temperature Rising Time

Temperature rising range: 0°C to 80°C (with cover), Room temperature 20°C, Unit (minute-min.)

Rising Reached Temp.(°C)	BV100 (min.)	°C/min.	BV200 (min.)	°C/min.	BV300 (min.)	°C/min.
0	-	-	-	-	-	-
10	15	0.7	12	0.8	17	0.6
20	16	0.7	15	0.7	20	0.5
30	17	0.5	18	0.6	23	0.4
40	21	0.5	18	0.6	27	0.3
50	13	0.7	12	0.8	16	0.7
60	17	0.7	13	0.8	15	0.7
70	14	0.7	13	0.8	15	0.7
80	27	0.7	13	0.8	17	0.6
Total (approx.)	140min.	-	114min.	-	150min.	-

2) Temperature Falling Time

Temperature falling range: 80°C to natural falling (without cover) Room temperature 20°C, Unit (minute-min.)

Rising Reached Temp.(°C)	BV100 (min.)	°C/min.	BV200 (min.)	°C/min.	BV300 (min.)	°C/min.
80	-	-	-	-	-	-
70	110	0.08	120	0.08	155	0.65
60	140	0.07	150	0.07	205	0.05
50	180	0.05	205	0.05	280	0.04
40	275	0.03	295	0.03	415	0.02
30	35	0.3	30	0.3	35	0.29
20	75	0.3	40	0.3	45	0.22
10	55	0.2	55	0.2	55	0.18
0	90	0.08	120	0.08	115	0.09
Total (approx.)	960min.	-	1015min.	-	1300min.	-

Next, prepare the temperature program for BV300 Model based on the temperature rising/falling time.

Program Operation

Program creation

The program pattern below is explained as an example.

1. Program pattern example

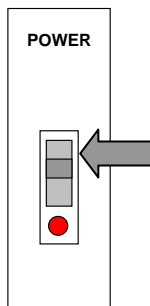
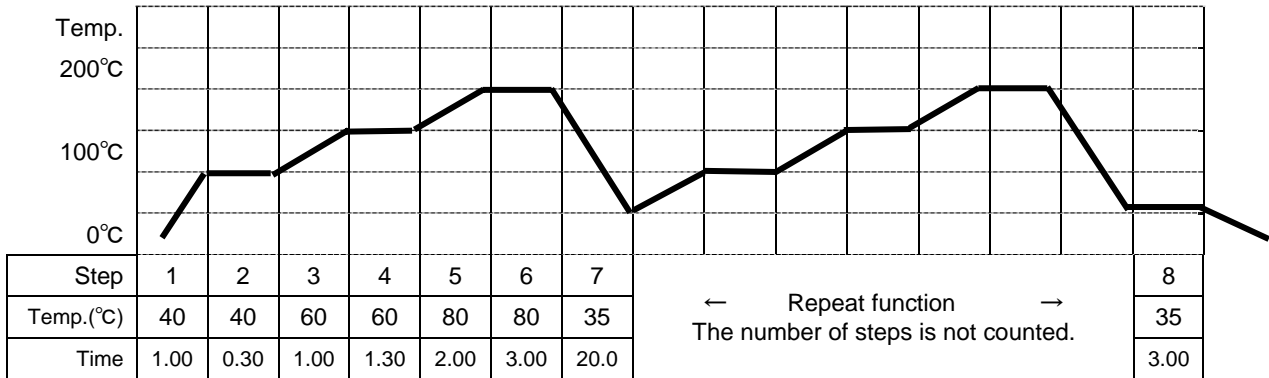

2. Turn on the power

- Turn on the power switch of the unit.
- The display on the controller lights on.
- The initial screen is displayed for about four seconds, then the measurement temperature (temperature in furnace) is displayed.
- ❖ The initial screen displays the software version information, sensor used and setting temperature of overheating prevention device.

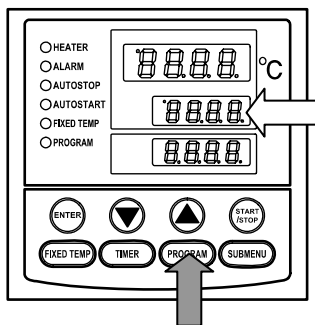

3. Select program mode/program pattern

- ① Press the PROGRAM key once.
The measurement temperature display screen displays the previous program mode.
Press the PROGRAM key again to display the next program mode.
 - ② Select the mode and press the ENTER key.
 - When PrG1 is selected, the measurement temperature display screen displays "End".
 - When PrG2 is selected, the measurement temperature display screen displays the program pattern "PAT1". For the pattern of PrG2, select "1" or "2" using the "▲▼". Press the ENTER key again. The measurement temperature display screen displays "End".
 - When PrG3 is selected, the measurement temperature display screen displays "PAT1". For the pattern of PrG3, select "1", "2" or "3" using the "▲▼". Press the ENTER key again. The measurement temperature display screen displays "End".
- ❖ Any of PrG1, PrG2 or PrG3 can be selectable in the program example above, where nine steps maximum are used.

Program Operation

The example shown below explains the method of program registration using PrG3.

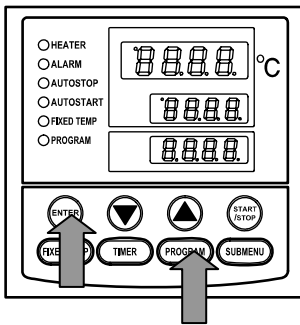

4. Register program

- ① Select PrG3 referring to 3 mentioned above.
- ② Input the number of steps, temperature and time for respective steps using the program creation sheet.
- ③ Press the ENTER key. The PA t 1 is displayed with blinking. ("End" is displayed if PrG1 is selected. In this case, go to ⑥)
- ④ Select the unused pattern from among Pat1, Pat2 and Pat3 using the "▲▼".
- ⑤ Press the ENTER key. "End" is displayed and the step number "n" is also displayed with blinking.
 - ❖ "End" is a character which indicates the total step number to be used. "8" will be input here.
- ⑥ INPUT "8", which is the total step number to be used here, using the "▲▼".
- ⑦ Press the ENTER key. The character "SV-1", which indicates the setting temperature of the first step, is displayed. The current setting temperature is also displayed with blinking.
- ⑧ Set the temperature of the first step using the "▲▼".
- ⑨ Press the ENTER key. The character "t-1", which indicates the setting time of the first step, is displayed. The current setting time is also displayed with blinking.
 - ❖ Before setting the time, check the temperature rise/fall capability of unit.
 - ❖ For example, about 120 minutes is needed to increase the temperature from room temperature to 80°C for BV300 type. Add an extra considering the temperature stability time.
- ⑩ After the time is set, press the ENTER key.
- ⑪ The character "SV-2", which indicates the setting temperature of the second step, is displayed. In the same way, input the temperature and time for respective steps using the program creation sheet.

The different method is necessary where program repeat function is used. In this case, press the SUBMENU key after setting the time (t-7 in the example) in the step where the repeat operation is to be used (Step 7 in the example). This enters to the repeat function setting mode.

 - ❖ Follow the "Use program repeat function" in page 28 for the input method of program repeating function.
- ⑫ The screen returns to the initial setting screen after the setting of temperature and time in the final step is completed.

Verification run:

Make sure to check the setting temperature and time by operating the unit without load before performing actual run with samples.

Program Operation

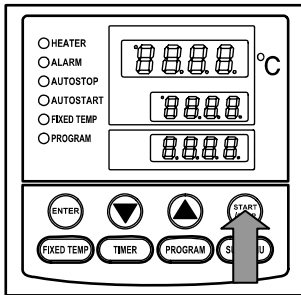

5. Start program operation

- Press the START/STOP key for about one second. The program operation previously set starts.
- The PROGRAM lamp lights on and the setting temperature screen displays the step currently under operation.
- ❖ Press the "▼" to check the setting temperature and residual time of step currently under operation on the setting temperature screen.

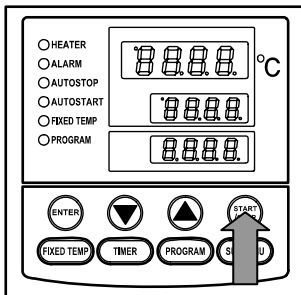

6. End program operation

- Buzzer continues to sound for about five minutes at operation stop.
- The measurement temperature screen displays the character "END", which indicates the termination of program.
- Press the START/STOP key to return to the initial screen.

Timer function:

- The maximum setting time is "999 hours and 50 minutes".
- The time can be set in increments of a minute under 99 hours and 59 minutes.
- It can be set in increment of ten minutes over 100 hours.
- The "▼▲" can change the setting time quickly when it is pressed continuously. Press them discontinuously when fine adjustment is needed.

To correct or check setting...

Press the FIXED TEMP key to correct the created program or to check the setting value. The screen returns to the former one, where correction or check is possible.

Last screen is displayed when the FIXED TEMP key is once pressed.

Note: Correction or check should be made on the program setting screen.

Wait operation in program operation

The succeeding step does not start in case the measurement temperature does not reach to, or exceeds the setting temperature when a program goes to the next step in program operation. This unit, however, is previously set to carry out the next step if the measurement temperature is within $\pm 3^{\circ}\text{C}$ of the setting temperature.

Program Operation

Use program repeat function

This section explains how to register the program repeat (repeating a program pattern) in program operation.

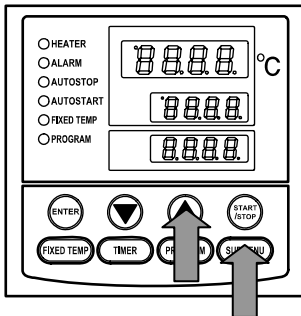

This section explains the registration procedure of program using repeat function in "4. Register program" above.

The procedure sets the step number to be repeated "PS-n" and repeating times "Pc-n"(n: step number)

- ① Press the SUBMENU key in stead of the ENTER key after setting the time (t-7 in the example) in the step where the repeat operation is to be used (Step 7 in the example). This enters to the repeat function setting mode.
- ② The measurement temperature screen displays the character "PS-n", which indicates the step to be repeated in the program pattern. The measurement temperature screen indicates "PS-7" in the example because repeat function is used at the seventh step. The step number 1 to 7 can be input in the setting temperature display screen. Enter the number (1 in the example) using the "▲▼".
- ③ Press the SUBMENU key.
The measurement temperature screen displays the character "Pc-n", which indicates the repeating times. Enter the value of repeating times (2 in the example) with the "▲▼".
- ④ The screen goes to that for the next step when the SUBMENU key is pressed again.
The screen to input the Sv-8 is displayed next in the example.

To correct or check setting...

Correction of setting during the repeat setting mode is impossible.

To correct or check the setting, end the setting of step currently input. Press the FIXED TEMP key after the temperature setting screen for the next step appears. The screen returns to the former one and re-setting is possible.

Note: Correction or check should be made on the program setting screen.

Program Operation

Programming Preparation Form 1

(Please use this form by making copies)

Register with:	PrG1 PrG2 PrG3	PAt1 PAt2 PAt3	No.	
Project Name			Date	
			Programmer	

Program Pattern

80°C	
50°C	
20°C	
STEP	

Program Operation

Programming Preparation Form 2

(Please use this form by making copies)

Register with:	PrG1 PrG2 PrG3	PA1 PA2 PA3	No.	
Project Name				Date
				Programmer

Input Value

	Temperature (°C)	Time (min.)	Repeat Function
Step 1		:	To/Times
Step 2		:	/
Step 3		:	/
Step 4		:	/
Step 5		:	/
Step 6		:	/
Step 7		:	/
Step 8		:	/
Step 9		:	/
Step 10		:	/
Step 11		:	/
Step 12		:	/
Step 13		:	/
Step 14		:	/
Step 15		:	/
Step 16		:	/
Step 17		:	/
Step 18		:	/
Step 19		:	/
Step 20		:	/
Step 21		:	/
Step 22		:	/
Step 23		:	/
Step 24		:	/
Step 25		:	/
Step 26		:	/
Step 27		:	/
Step 28		:	/
Step 29		:	/
Step 30		:	/

Other Functions

Use calibration offset function

Calibration offset is a function which corrects the difference between the temperature in furnace and that of controller (sensor temperature) if arises. The function parallel corrects the difference either to the plus or minus side within the whole temperature range of unit. The function can be set or cancelled by the SUBMENU key.

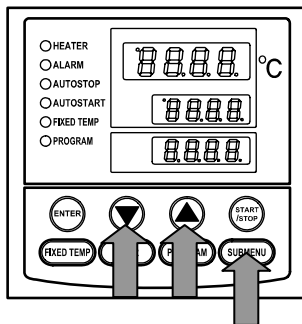
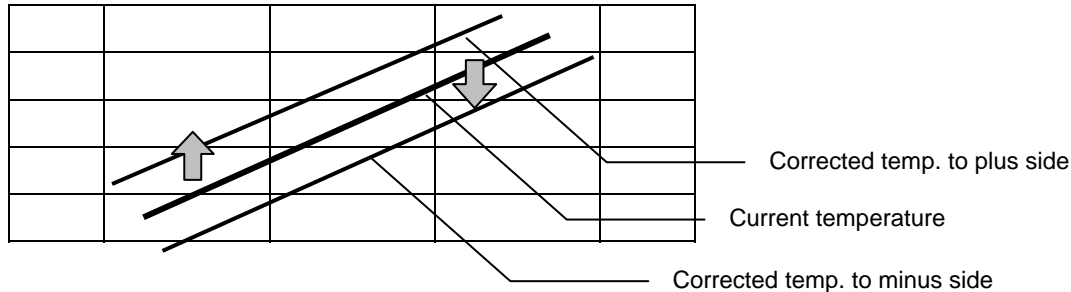

- ① Start operation with the target setting temperature. Check the temperature in furnace (temperature of sample) with a thermograph after it is stabilized.
 - ② Check the difference between the setting temperature and that in furnace (temperature of sample).
 - ③ Press the SUBMENU key. Select the character "cAL", which indicates the calibration offset, using the "▲▼", and then press the ENTER key.
 - ④ Input the difference using the "▲▼" and then press the ENTER key. This completes the setting.
- ❖ The setting range of offset correction temperature is +99°C to plus side and -99°C to minus side respectively.
When it is set to the minus side, the temperature on the measurement temperature display screen falls by the setting temperature, while the temperature on furnace rises.
When it is set to the plus side, the temperature on the measurement temperature display screen rises by the setting temperature, while the temperature on furnace falls.
 - ❖ The unit has two-point correction function, which performs offset between low-temperature zone and high-temperature zone. Please consult our local branch office when carrying out validation of temperature controller.

Use lock function

This function locks the operation status previously set. The function can be set or cancelled by the SUBMENU key.

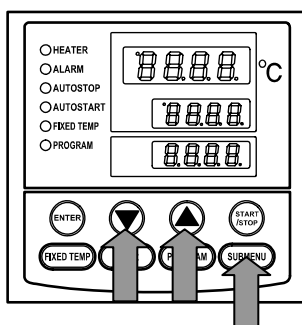

- ① Press the SUBMENU key. Select the character "Lock", which indicates the lock of setting value, using the "▲▼", and then press the ENTER key.
 - ② The setting temperature screen displays "oFF". The setting value is locked when it is turned to "o n " using the "▲".
 - ③ Press the SUBMENU key again to cancel the lock. Select the character "Lock", which indicates the lock of setting value, using the "▲▼", and then press the ENTER key. Select "oFF" with the "▼" and then press the ENTER key to cancel the function.
- ❖ All keys other than the START/STOP and SUBMENU keys are lock when the lock function is on.

WARNING!

If a problem occurs

-  If smoke or strange odor should come out of this unit for some reason, turn off the power key right away, and then turn off the circuit breaker and the main power. Immediately contact a service technician for inspection. If this procedure is not followed, fire or electrical shock may result. Never perform repair work yourself, since it is dangerous and not recommended.

Substances that cannot be used

-  Never use explosive substances, flammable substances and substances that include explosive or flammable ingredients in this unit. Explosion or fire may occur. (Refer to page41 "List of Dangerous Substances".)

CAUTION!

Do not step on this unit

-  Do not step on this unit. It will cause injury if this unit fall down or break.

Do not put anything on this unit

-  Do not put anything on this unit. It will cause injury if fall.

During a thunder storm

-  During a thunderstorm, turn off the power key immediately, then turn off the circuit breaker and the main power. If this procedure is not followed, fire or electrical shock may be caused.

Clean this unit with enough

-  Though this unit is cleaned beforehand, clean it with enough after leaving for a long period or when using it for the first time.

Notice of the applicable solution for test bath

-  Apply either water or alcoholic solution as the liquid to be poured into test bath. When applying water, apply either ion exchange water or distilled water, and purify it sometimes. Using the ground water or tap water might accumulate a fur or dirt, and also might affect (descend) the efficiency or life of the heater or Peltier component. Purify it frequently. When applying an alcohol, do apply the ethyl alcohol solution, and pay attention to the status of this solution not to be frozen depending on the operation temperature. (Refer to Page 10 "Preparation".)

Refilling water or alcohol

-  When applying either water or ethanol, it evaporates gradually. Refill it sometimes. When refilling it, do not spill from or spread over the water bath. If a water or ethanol is spilt over the operation panel, wipe it off completely. Failure to do so could cause the electric leakage or electric shock.

Countermeasure for stop operation during night or long-term stop

-  In case of stopping operation during night or long-term, toggle the power switch (earth leakage breaker) to "OFF".

CAUTION!

Pay attention not to heat empty bath.



Do not operate this unit with empty water bath. Though the float switch for prevent empty heating is equipped, be sure to check the water amount of the water bath before the operation, and keep the proper water level while the operation.

Return after power failure



When power is supplied after a power failure, the device automatically starts operation again with the same state as just before the power failure. It is danger that the device starts unattached operation after a power failure. We recommend for you to turn off the switch of this unit if a power failure occurs during operation.

Using the top cover (optional accessory)



- Check that the water is in the water bath. Plug the cord in the outlet. Then turn on the power switch.
- Do not touch any place of the top cover other than the handle. The whole top cover except the handle becomes hot while handling in the high temperature environment.
- When removing the top cover, lift whole cover gradually by grasping the handle, and pulling frontward of the user. Removing the top cover in a stroke or removing it by holding the front side of it could get burned by the steam.

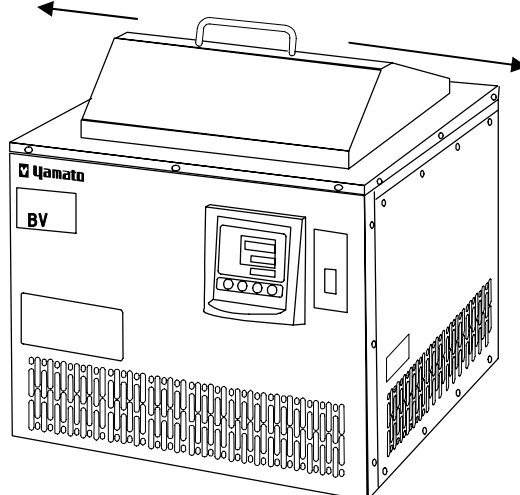

Drain of the Liquid in the Bath



Drain the liquid in the bath using the attached drain pump. Pay attention to not spilling the liquid from the water bath, or not spreading over the bath.

Daily Inspection and Maintenance

For the safety use of this unit, please perform the daily inspection and maintenance without fail. Using the city water to this unit might attach dirt. Do inspect and maintain this point while performing daily inspection and maintenance.

WARNING!

- Disconnect the power cable from the power source when doing an inspection or maintenance unless needed.
- Perform the daily inspection and maintenance after returning the temperature of this unit to the normal one. (Be sure to check the water in the test bath is cooled down.)
- Do not disassemble this unit.

CAUTION!

Main unit maintenance

- Use a well-drained soft cloth to wipe dirt on this unit. Do not use benzene, thinner or cleanser for wiping. Do not scrub this unit. Deformation, deterioration or color change may result in.

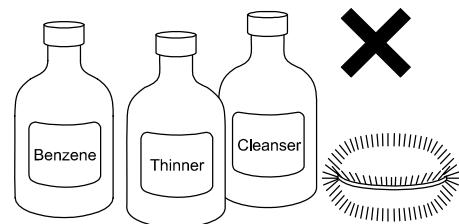

Water bath maintenance

- When a fur or dirt is attached or floated in the water bath, drain the water from the water bath using the attached drain pump, clean the bath using the neutral detergent completely, and flush it with enough. Never use the alkaline detergent. (When this unit is not used for a long time, make the bath be empty, and store it to the place with little humidity.)

Monthly maintenance

- Check the earth leakage breaker function.
 1. Connect the power cord.
 2. Turn the breaker on.
 3. Push the red test switch by a ballpoint pen etc.
 4. If there is no problem, the earth leakage breaker will be turned off.

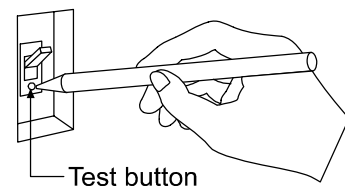

Hose replacement

- For using this unit with stability, replace the hose once per two year as a guide. Please ask Yamato Scientific to the hose replacement.

For any questions, contact the dealer who you purchased this unit from, or the nearest sales division in our company.

When not using this unit for long term / When disposing

CAUTION!

When not using this unit for long term...

- Turn off the power and disconnect the power cord.

WARNING!

When disposing...

- Keep out of reach of children.
- Remove the driving parts.
- Treat as large trash.

Environmental protection should be considered

We request you to disassemble this unit as possible and recycle the reusable parts considering to the environmental protection. The feature components of this unit and materials used are listed below.

Component Name	Material
Exterior Parts	
Main body	Steel plate, Melamine resin coating
Interior	Stainless steel SUS304, Urethane foam resin, ABS resin, etc.
Cover	Urethane foam resin
Production plates	Polyethylene (PET) resin film
Cooling Parts	
Heat absorb unit	Copper pipe, Aluminum
Heat radiate fin	Copper plate, Lead solder
Heat radiate cover	Steel plate, Melamine resin coating
Parts attaching plate	Steel plate, Melamine resin coating
Electrical Parts	
Heater	Copper pipe
Fan	Aluminum, Copper wire and other composites
Boards	Composites with board, condenser, resistance, transformer, etc.
Power cord, Wiring material, and the other	Synthetic rubber, Resin

Error Display

This unit has an automatic diagnosis function built in the controller and safety devices independent of the controller. The table below shows the cause and the solution method when the safety device operates.

Error Code:

When an abnormal condition occurs, an error code appears and the alarm lamp lights in the controller, the buzzer sounds simultaneously. Record the error code and turn off the power of device immediately.

Safety Device	Notify	Cause/Solution
Sensor trouble detection	"ALARM" lamp lights on, "Er.01" appears	<ul style="list-style-type: none"> Temperature sensor is broken or disconnected. Make a call for service.
SSR short-circuit detection	"ALARM" lamp lights on, "Er.02" appears	<ul style="list-style-type: none"> Triac is in short-circuit Make a call for service.
Heater disconnecting detection	"ALARM" lamp lights on, "Er.03" appears	<ul style="list-style-type: none"> Heater is disconnected. Make a call for service.
Memory error	"ALARM" lamp lights on, "Er.15" appears	<ul style="list-style-type: none"> Failure in internal memory. Make a call for service.
Internal communication error	"ALARM" lamp lights on, "Er.17" appears	<ul style="list-style-type: none"> Failure in internal communication or temperature inputting circuit. Make a call for service.
Overheating	"ALARM" lamp lights on, "Er.19" appears	<ul style="list-style-type: none"> Overheating prevention device is in operation. Reset the power supply, and then adjust the setting temperature of the overheating protection device. If the state does not recover, make a call for service.
Abnormal fluid level	"ALARM" lamp lights on, "Er.20" appears	<ul style="list-style-type: none"> Water level is low. Float switch Make a call for service.
Measurement temperature error	"ALARM" lamp lights on, "----" appears	<ul style="list-style-type: none"> Measurement value is out of display range. Make a call for service.

Trouble Shooting

Condition	Possible Causes
The device does not start when turning on the power switch.	<ul style="list-style-type: none">• Power source is turned off.• Power failure.
Alarm lamp lights on.	<ul style="list-style-type: none">• Setting value of overheating prevention is lower than that of in-bath temperature.
Temperature does not rise.	<ul style="list-style-type: none">• The setting temperature is lower than that of in-bath temperature.• Too many samples.
Temperature does not fall.	<ul style="list-style-type: none">• The setting temperature is higher than that of in-bath temperature.• In-bath temperature is higher than 40°C. (The cooling device turns ON at 40°C or less)• Too many samples.
The circulating pump produces unusual noise.	<ul style="list-style-type: none">• Check if air remains in the circulating pump.

When power failure occurs...

- When power is supplied after a power failure, the device automatically starts operation again with the same state as just before the power failure. It is danger that the device starts unattached operation after a power failure.
- We recommend for you to turn off the switch of device if a power failure occurs during operation.

In the case if the error other than listed above occurred, turn off the power switch and primary power source immediately. Contact the shop of your purchase or nearest Yamato Scientific Service Office.

In Case of Request for Repair

If the failure occurs, stop the operation, turn OFF the power switch, and unplug the power plug. Please contact the sales agency that this unit was purchased, or the Yamato Scientific's sales office.

< Check following items before contact >

- ◆ Model Name of Product
 - ◆ Production Number
 - ◆ Purchase Date
 - ◆ About Trouble (in detail as possible)
- } See the production plate attached to this unit.

Minimum Retention Period of Performance Parts for Repair

The minimum retention period of performance parts for repair of this unit is 7 years after discontinuance of this unit.

The "performance part for repair" is the part that is required to maintain this unit.

Specification

	BV100	BV200	BV300
Operating temperature range	0 to 80°C (room temp.:20°C)*		
Temperature adjustment accuracy	±0.1°C (water temp.:20°C, room temp.:20°C)		
Temperature distribution accuracy	±0.1°C (water temp.:20°C, room temp.:20°C)		
Time required to reach highest temperature	Approx. 90min.		Approx. 100min.
Time required to reach lowest temperature	Approx. 180min.		
In-bath material	Stainless steel SUS304		
Temperature control system	PID control by microcomputer (VS-4 type controller)		
Temperature control system sensor	Platinum resistance bulb (Pt 100)		
Temperature setting system	Digital setting		
Temperature display system	Digital display		
Overheating prevention system	ON/OFF control by microcomputer		
Overheating prevention setting system	Digital setting		
Overheating prevention sensor	K-thermocouple (W-sensor with Pt 100)		
Heater	Copper pipe heater (Nickel plated)		
	0.5KW	0.6KW	0.75KW
Cooling device	4 peltier elements	6 peltier elements	8 peltier elements
Cooling fan	DC fan		
Stirrer	Magnet pump		
	3W	6W	
Timer	1 minute to 99 hours 59 minutes, and 100 hours to 999.5 hours Digital setting, Auto start, Quick/Auto stop, Program operation		
Safety device	Earth leakage breaker, Empty heating prevention device, Overheating prevention device, Self-diagnostic functions (heater disconnection, SSR short circuit, overheat prevention)		
Internal dimensions (W × D × H mm)	200 × 220 × 150	250 × 270 × 180	380 × 270 × 180
External dimensions (W × D × H mm)	340 × 538 × 415	380 × 538 × 415	520 × 538 × 415
In-bath capacity	Approx. 6L	Approx. 10L	Approx. 15L
Power supply (50/60Hz)	100V AC		
	10A	14A	18A
Weight	Approx. 35Kg	Approx. 40Kg	Approx. 48Kg
Accessories	Shelf, Drain pump, Cover, Instruction manual		
Optional accessories	Test tube rack, Clamp set, Water bath top cover(arched type)		

*) Case of using 10% ethanol solution.

Optional Accessories

Name	Product code	Apply
Clamp set	200000	BV100/200/300
Water bath top cover (SUS)	200000	BV100
	200000	BV200
	200000	BV300
Rack (SUS)	200000	BV100
	200000	BV200
	200000	BV300

Wiring Diagram

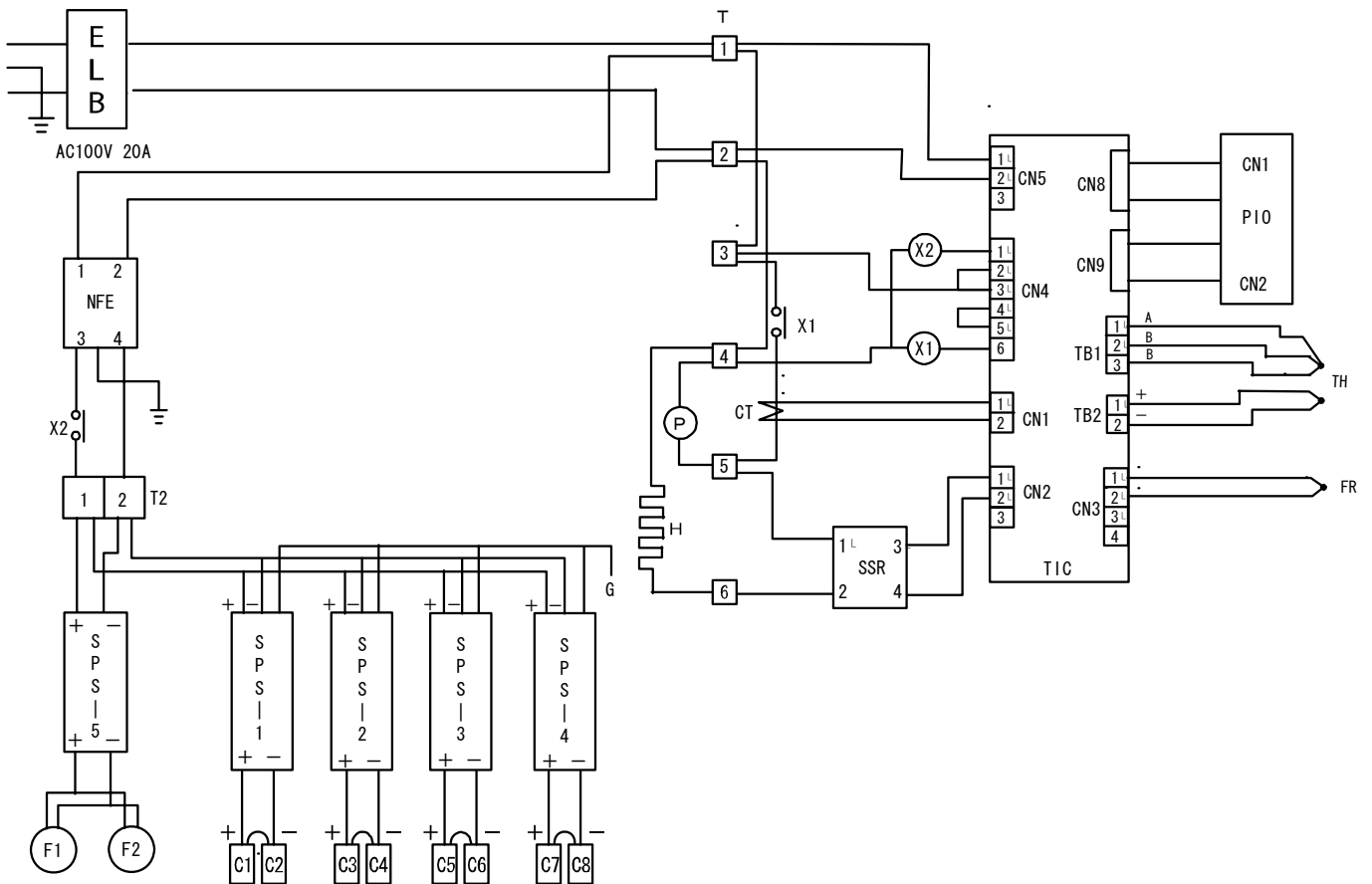

Symbol	Part name	Symbol	Part name
ELB	Earth leakage breaker (BV100)	F1,2	Cooling fan (BV100)
	Earth leakage breaker (BV200/300)		Cooling fan (BV200/300)
X1,X2	Relay		Cooling fan (BV300)
SSR	Solid state relay	H	Heater (BV100)
CT	Current transformer		Heater (BV200)
T	Terminal block		Heater (BV300)
TIC	Planar board	SPS1 to 5	Switching board
PIO	Display circuit board	C1 to 8	Peltier element
FR	Float switch	TH	W sensor
P	Pump	NFE	Noise filter

Replacement Parts Table

Common Use Parts

Part Name	Code No.	Specification	Manufacturer
W-sensor	1160030047	K-thermocouple φ 4.8L × 125L PT1/8	Yamato Scientific
X1 Relay	2050000043	AJR3714	Matsushita
X2 Relay	2050000019	AHE1254 100V	Matsushita
SSR	2160000035	TRS5225	Toho Denshi
Float switch	2040020003	NVH-112YA	Tokyo Seigyo
VS type thermoregulator board	1020000053	VS-4 (program)	Yamato Scientific
Current transform cell	2170010005	CTL-6-S-H	URD
Noise filter	2300010002	ZAG2220-11S	TDK
Cooling device	LT00005289	9500-127-085BS	

BV100

Pipe heater	BV10040030	100V 500W (5A)	Yamato Scientific
Earth leakage breaker	2060000018	FG32R/10-30MA 10A	Fuji Denki
Magnet pump	D0020010	CP05-PPRE-10 3W	Nickisou
DC fan motor	2150000020	109P1412H102 (Rib is attached)	Sanyo Denki

BV200

Pipe heater	BV20040020	100V 600W (6A)	Yamato Scientific
Earth leakage breaker	2060000019	FG32R/15-30MA 15A	Fuji Denki
Magnet pump	D0020010	CP05-PPRE-10 3W	Nickisou
DC fan motor	2150000018	109P1212H102 (Rib is attached)	Sanyo Denki

BV300

Pipe heater	BV20040020	100V750W (7.5A)	Yamato Scientific
Earth leakage breaker	2060000020	FG32R/20-30MA 20A	Fuji Denki
Magnet pump	D0020011	CP08-PPRE-10 6W	Nickisou
DC fan motor	2150000020	109P1412H102 (Rib is attached)	Sanyo Denki

List of Dangerous Substances



Never use explosive substances, flammable substances and substances that include explosive or flammable ingredients in this unit.

EXPLOSIVE

EXPLOSIVE:	Ethylene glycol dinitrate (nitro glycol), Glycerin trinitrate (nitroglycerine), Cellulose nitrate (nitrocellulose), and other explosive nitrate esters
	Trinitrobenzene, Trinitrotoluene, Trinitrophenol (picric acid), and other explosive nitro compounds
	Acetyl hidroperoxide (peracetic acid), Methyl ethyl ketone peroxide, Benzyl peroxide, and other organic peroxides

FLAMMABLE

IGNITING:	Lithium (metal), Potassium (metal), Sodium (metal), Yellow phosphorus, Phosphorus sulfide, Red phosphorus, Celluloid compounds, Calcium carbide, Lime phosphate, Magnesium (powder), Aluminum (powder), Powder of metals other than magnesium and aluminum, Sodium hydrosulfite
OXIDIZING:	Potassium chlorate, Sodium chlorate, Ammonium chlorate, and other chlorate
	Potassium perchlorate, Sodium perchlorate, Ammonium perchlorate, and other perchlorate
	Potassium peroxide, Sodium peroxide, Barium peroxide, and other inorganic peroxide
	Potassium nitrate, Sodium nitrate, Ammonium nitrate, and other nitrate
	Sodium chlorite and other chlorites
	Calcium hypochlorite and other hypochlorites
INFLAMMABLE LIQUID:	Ethyl ether, Gasoline, Acetaldehyde, Propylene chloride, Carbon disulfide, and other flammable substances having a flash point of lower than -30°C
	Normal hexane, ethylene oxide, acetone, benzene, methyl ethyl ketone, and other flammable substances having a flash point of -30°C or higher but lower than 0°C
	Methanol, Ethanol, Xylene, Pentyl acetate (amyl acetate), and other flammable substances having a flash point of 0°C or higher but lower than 30°C
	Kerosene, Light oil (gas oil), Oil of turpentine, Isopentyl alcohol (isoamyl alcohol), Acetic acid, and other flammable substances having a flash point of 30°C or higher but lower than 65°C
FLAMMABLE GAS:	Hydrogen, Acetylene, Ethylene, Methane, Propane, Butane, and other flammable substances which assume a gaseous state at 15°C and 1 atm

(Source: Appendix Table 1 of Article 6 of the Industrial Safety and Health Order in Japan)

Responsibility

Please follow the instructions in this document when using this unit. Yamato Scientific has no responsibility for the accidents or breakdown of device if it is used with a failure to comply. Never conduct what this document forbids. Unexpected accidents or breakdown may result in.

Note

- ◆ The contents of this document may be changed in future without notice.
- ◆ Any books with missing pages or disorderly binding may be replaced.

Instruction Manual for
Low Constant Temperature Water Bath
Model BV100/200/300
Second Edition February. 14, 2012
Revised Feb. 20, 2012

Yamato Scientific Co., Ltd.
2-1-6 Nihonnbashi Honcho, Chuo-ku,
Tokyo, 103-8432, Japan
<http://www.yamato-net.co.jp>