

# Yamato

Water Bath

**BM500/510**

Oil Bath

**BO400/410**

**Instruction Manual**

- Fourth Edition -

- Thank you for purchasing "Water Bath, BM / Oil Bath, BO Series" of Yamato Scientific Co., Ltd.
- To use this unit properly, read this "Instruction Manual" thoroughly before using this unit. Keep this instruction manual around this unit for referring at anytime.

**⚠WARNING!**

Carefully read and thoroughly understand the important warning items described in this manual before using this unit.

**Yamato Scientific Co. LTD.,**

◆ <b>1.Cautions in Using with Safety</b> .....	<b>1</b>
• Explanation.....	1
• Table of Illustrated Symbols .....	2
• Fundamental Matters of "WARNING!" and "CAUTION!" .....	3
◆ <b>2.Before Using This Unit</b> .....	<b>5</b>
• Requirements for Installation.....	5
• Installation Method .....	8
• Preparations for Operation .....	9
◆ <b>3.Description and Function of Each Part</b> .....	<b>12</b>
• Main Unit .....	12
• Control Panel.....	13
• Characters of the Controller .....	14
◆ <b>4.Operation Method</b> .....	<b>15</b>
• Operation Mode and Function List .....	15
• Operation Mode, Function Setting Key, and Characters .....	17
• Fixed Temperature Operation.....	18
• Quick Auto Stop Operation.....	19
• Auto Stop Operation.....	21
• Auto Start Operation.....	23
• Setting of Overheating Prevention Device .....	25
• Key Lock Function.....	26
• Bath Operation Setting Function .....	26
• Calibration Offset Function.....	27
• Reparation Function at Power Failure.....	28
◆ <b>5.Handling Precautions</b> .....	<b>29</b>
◆ <b>6.Maintenance Method</b> .....	<b>31</b>
• Daily Inspection and Maintenance .....	31
◆ <b>7.Long storage and disposal</b> .....	<b>32</b>
• When not using this unit for long term / When disposing .....	32
• Environmental protection should be considered .....	32
◆ <b>8.In the Event of Failure</b> ... ..	<b>33</b>
• Safety Device and Error Code.....	33
• Trouble Shooting .....	34
◆ <b>9.After Service and Warranty</b> .....	<b>35</b>
• In Case of Request for Repair.....	35
◆ <b>10.Specification</b> .....	<b>36</b>
◆ <b>11.Wiring Diagram</b> .....	<b>37</b>
◆ <b>12.Replacement Parts Table</b> .....	<b>39</b>
◆ <b>13.Reference</b> .....	<b>40</b>
◆ <b>14.Installation Standard Manual</b> .....	<b>41</b>

### MEANING OF ILLUSTRATED SYMBOLS

#### Illustrated Symbols

Various symbols are used in this safety manual in order to use the unit without danger of injury and damage of the unit. A list of problems caused by ignoring the warnings and improper handling is divided as shown below. Be sure that you understand the warnings and cautions in this manual before operating the unit.

---

 **WARNING!** If the warning is ignored, there is the danger of a problem that may cause a serious accident or even fatality.

 **CAUTION!** If the caution is ignored, there is the danger of a problem that may cause injury/damage to property or the unit itself.

---

(Note 1) Serious injury means a wound, an electrical shock, a bone fracture or intoxication that may leave after effects or require hospitalization of outpatient visits for a long time.

(Note 2) Minor injury means a wound or an electrical shock that does not require hospitalization or outpatient visits for a long time.

(Note 3) Property damage means damage to facilities, devices and buildings or other properties.

#### Meaning of Symbols

 This symbol indicates items that urge the warning (including the caution). A detailed warning message is shown adjacent to the symbol.

 This symbol indicates items that are strictly prohibited. A detailed message is shown adjacent to the symbol with specific actions not to perform.

 This symbol indicates items that should be always performed. A detailed message with instructions is shown adjacent to the symbol.

# 1. Cautions in Using with Safety

## Table of Illustrated Symbols

### Warning



Warning,  
generally

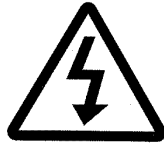

Warning,  
high voltage



Warning,  
high temperature



Warning,  
drive train



Warning,  
explosive

### Caution



Caution,  
generally



Caution,  
electrical shock



Caution,  
scald



Caution,  
no road heating



Caution,  
not to drench



Caution,  
water only



Caution,  
deadly poison

### Prohibit



Prohibit,  
generally



Prohibit,  
inflammable



Prohibit,  
to disassemble



Prohibit,  
to touch

### Compulsion



Compulsion,  
generally



Compulsion,  
connect to the  
grounding  
terminal



Compulsion,  
install on a flat  
surface



Compulsion,  
disconnect the  
power plug



Compulsion,  
periodical  
inspection

# 1.Cautions in Using with Safety

## Fundamental Matters of "WARNING!" and "CAUTION!"

### **WARNING!**

#### **Do not use this unit in an area where there is flammable or explosive gas**

Never use this unit in an area where there is flammable or explosive gas. This unit is not explosion-proof. An arc may be generated when the power switch is turned on or off, and fire/explosion may result. (Refer to page 409 "List of Dangerous Substances".)

#### **Always ground this unit**

Always ground this unit on the power equipment side in order to avoid electrical shock due to a power surge.

#### **Ban on operation when an abnormality occurs**

If smoke or strange odor should come out of this unit for some reason, turn off the circuit breaker right away, and then disconnect the power plug. If this procedure is not followed, fire or electrical shock may result.

#### エラ ー！ リン クが 正し くあ りま せ ん。 **Do not use the power cord if it is bundled or tangled**

Do not use the power cord if it is bundled or tangled. **If this procedure is not followed, fire or electrical shock may result.**

#### **Do not process, bend, wring, or stretch the power cord forcibly**

Do not process, bend, wring, or stretch the power cord forcibly. Fire or electrical shock may result.

#### **Perform periodic check**

Check the device frequently. Do not leave the dust and dirt on the wiring terminals and electrical components. A fire disaster may result in.

#### **Never use an explosive or a flammable material with this unit**

Never use explosive substances, flammable substances and substances that include explosive or flammable ingredients in this unit. Explosion or fire may occur. (Refer to page 40 "List of Dangerous Substances".)

#### **Do not touch high-temperature parts**

The inside of the body or the door may become hot during and just after operation. It may cause burns.

#### **Do not disassemble or modify this unit**

Do not disassemble or modify this unit. Fire or electrical shock or failure may be caused.

### **CAUTION!**



### **During a thunder storm**

During a thunderstorm, turn off the power key immediately, then turn off the circuit breaker and the main power. If this procedure is not followed, fire or electrical shock may be caused.



### **When electric power failure occurs...**

The device stops operation when electric power failure occurs. In this case, turn off the breaker for safety.

## 2. Before Using This Unit

### Requirements for Installation



#### 1. Always ground this unit



- Be sure to connect the ground wire to the earth conductor or earth terminal to prevent accidents caused by an electric shock.



- Do not connect the earth wire to gas or water pipes. If not, fire disaster may be caused.
- Do not connect the earth wire to the ground for telephone wire or lightning conductor. If not, fire disaster or electric shock may be caused.

- Use the receptacle with exclusive earth terminal for the BM500 and B0400 models which have large capacity with single-phase 100V to 120V specification.
- Use the receptacle with exclusive earth terminal for the BM510 and B0410 models with single-phase 200V to 240V specification.

#### 2. Choose a proper place for installation



- Do not install this unit in a place where:
  - ◆ Rough or dirty surface.
  - ◆ Flammable gas or corrosive gas is generated.
  - ◆ Ambient temperature above 35°C.
  - ◆ Ambient temperature fluctuates violently.
  - ◆ There is direct sunlight.
  - ◆ There is excessive humidity and dust.
  - ◆ There is a constant vibration.
  - ◆ There is not exhaustor and ventilator.



- Make sure that no flammable substances are placed around the devices. Keep space as shown, at least, in the figure below.

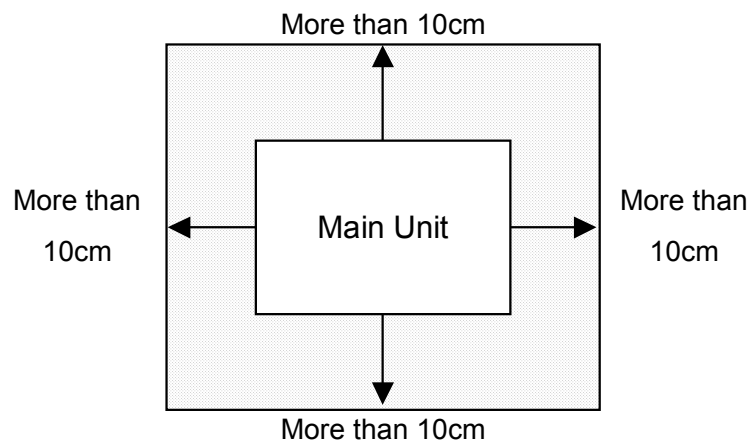

## 2. Before Using This Unit

### Requirements for Installation



#### 3. Do not use this unit in an area where there is flammable or explosive gas



- Never use this unit in an area where there is flammable or explosive gas. This unit is not explosion-proof. An arc may be generated when the power switch is turned ON or OFF, and fire/explosion may result.



- To know about flammable or explosive gas, refer to page 40 "List of Dangerous Substances".

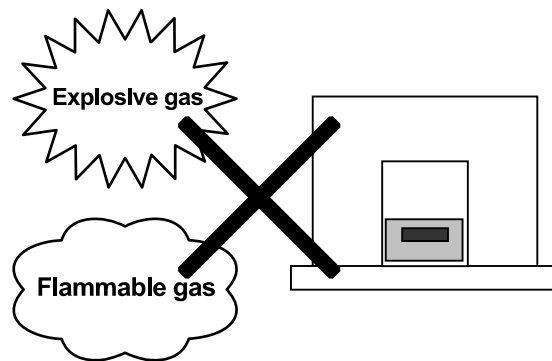

#### 4. Requirements for Installation



For BO400 and BO410 models...

The oily smoke of silicon oil generated by heating is flammable and may cause fire disaster. Silicon oil also may generate harmful gas when it reaches a high temperature. Be sure to install an exhauster, ventilator and extinguisher around the device.

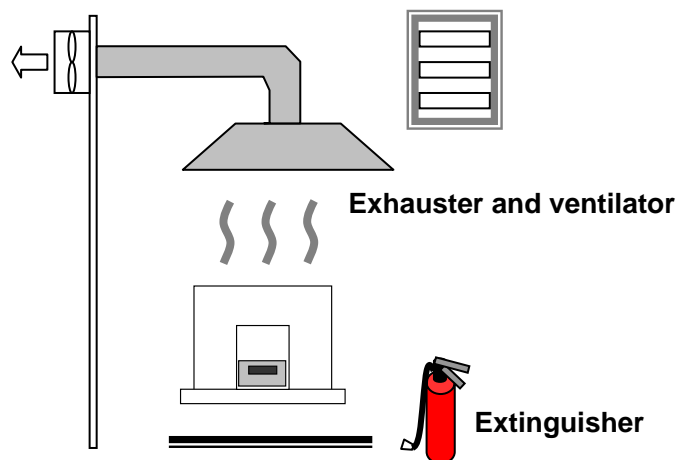



## 2. Before Using This Unit



### 5. Do not modify



Modification of this unit is strictly prohibited. This could cause a failure.

Modification

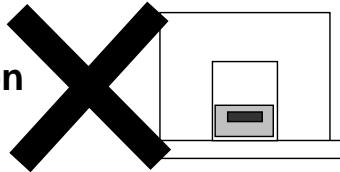

### 6. Installation on horizontal surface



Place this unit as flat a place as possible. If the rubber feet are not in uniform contact with the floor surface, noise or vibration may result. Additionally, the unit may cause a problem or malfunction.

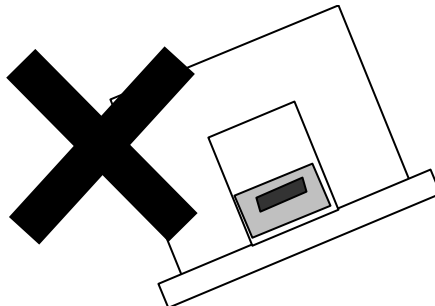

### 7. Choose a correct power distribution board or receptacle



- Choose a correct power distribution board or receptacle that meets the unit's rated electric capacity.

**Electric capacity:** BM500/BO400: 100 to 120V AC, 12.5A  
BM510/BO410: 200 to 240V AC (single phase), 6.5A

NOTE)

There could be the case that the unit does not run even after turning ON the power. Inspect whether the voltage of the main power is lowered than the specified value, or whether other device(s) uses the same power line of this unit. If the phenomena might be found, change the power line of this unit to the other power line.

### 8. Before/after installing



- It may cause injure to a person if this unit falls down or moves by the earthquake and the impact. etc..To prevent, take measures that the unit cannot fall down, and not install to busy place.
- Be sure to install an exhauster, ventilator and extinguisher around the device.

#### 9. Handling of power code

##### 1.Warning

- ⊘ Do not entangle the power cord. This will cause overheating and possibly a fire.
- Do not bend or twist the power cord, or apply excessive tension to it. This may cause a fire and electrical shock.
- Do not lay the power cord under a desk or chair, and do not allow it to be pinched in order to prevent it from being damaged and to avoid a fire or electrical shock.
- Keep the power cord away from any heating equipment such as a room heater. The cord's insulation may melt and cause a fire or electrical shock.
- ! If the power cord becomes damaged (wiring exposed, breakage, etc.), immediately turn off the power at the rear of this unit and shut off the main supply power. Then contact your nearest dealer for replacement of the power cord. Leaving it may cause a fire or electrical shock.
- Connect the power plug to the receptacle which is supplied appropriate power and voltage.

##### 2. Power cord connection



Use the attached power cord (rated current: 15A).



Connect power supply plug into power cord surely when to connect unit.

##### Use of power cord overseas

Use the power cord that meets the safety standard of relevant countries when the device is used overseas.





#### Precautions at operation for water bath BM500 and BM510

Be careful about the followings at the operation of device.

- ① Connect the power to the receptacle which has sufficient capacity left.
- ② Do not move the device during the operation.
- ③ Be careful not to burn yourselves during operation of device.
- ④ The temperature inside the bath and device, especially on the edge of bath, is high during and after the operation. Do not touch them with bare hands.
- ⑤ Do not drain the device until the water temperature falls to 45°C or below.
- ⑥ Do not spill water over the installation area of water bath on the main body when feeding water. The insulation failure or ground leakage may result in.
- ⑦ Do not perform unmanned operation.
- ⑧ Use water as medium. Ion-exchange water is recommended to be used to prevent adhesion of calculus.
- ⑨ Do not operate the device in the open air.
- ⑩ Turn off the power when removing the water bath from the main body.
- ⑪ Do not heat the bath without water in it.



#### Precautions at operation for oil bath BO400 and BO410

Be careful about the followings at the operation of device.

- ① Connect the power to the receptacle which has sufficient capacity left. BO400: AC100 to 120V for power supply voltage/approx. 12.5A for current capacity. BO410: AC200 to 240V for power supply voltage/approx. 6.5A for current capacity.
- ② Do not move the device during the operation.
- ③ Be careful not to burn yourselves during operation of device.
- ④ The temperature inside the bath and device, especially on the edge of bath, is high during and after the operation. Do not touch them with bare hands.
- ⑤ Do not drain the device until the oil temperature falls to 45°C or below.
- ⑥ Do not spill oil over the installation area of oil bath on the main body when feeding oil. The insulation failure or ground leakage may result in.
- ⑦ Do not perform unmanned operation.
- ⑧ Use silicon oil as medium. Do not use the other liquid other than it.
- ⑨ Do not operate the device in the open air.
- ⑩ Turn off the power when removing the oil bath from the main body.
- ⑪ Do not heat the bath without oil in it.
- ⑫ Be careful not to overflow the oil during heating.

## 2.Before Using This Unit

### Preparations for Operation

#### Fluid medium for oil bath BO400/BO410

The maximum operating temperature of BO400/410 model oil bath is 180°C.

Select the silicon oil used only for heat transfer medium, with heat resistance and open system (heat-resistant dimethyl silicon oil) having the viscosity of 50 mm<sup>2</sup>/s (cSt) or less.

Recommended silicon oil:

200°C or below for operating temperature, Made by Toshiba Silicon Co., Ltd. TSF458-50

Characteristics of silicon oil	Manufacturer	Toshiba Silicon
	Recommended temperature	200°C or below
	Product name	TSF458-50
	Appearance	Light yellow, transparent
	Specific gravity (25°C)	0.961
	Viscosity (25°C) mm <sup>2</sup> /s (cSt)	50
	Volatile (150°C, 24h)%	0.3
	Temperature coefficient of viscosity	0.59
	Ignition point (°C)	325
	Fluid point (°C)	-50°C or below
	Rate of increase in viscosity (300°C, 168h)%	40

The deterioration speed of silicon oil (viscosity change) varies depending on the operating temperature. Please inquire with the manufacturer of silicon oil for details at the time of purchase.

#### Water/oil amount supplied to in-bath

The maximum amount of fluid (water/silicon oil) at heating should be approximately 30 mm or less from the upper end of in-bath with the sample flask being sunk into the fluid.

**Be careful about the amount of silicon oil supplied in the oil bath.**

**Be sure that the amount of silicon oil supplied should be three liters or less.**

**Silicon oil has large thermal expansion and may overflow from the in-bath by heating.**

Consider the amount of oil which may overflow by heating before supplying oil into the in-bath.

Ex): When using TSF485-50, the amount of oil supplied can be calculated with the following formula.

Oil increment = (preset temperature – current temperature) × amount of oil × 0.00098

In case the preset temperature is 180°C, current temperature is 23°C, and amount of oil is 3.5ℓ, the amount to be supplied is:

$(180^{\circ}\text{C} - 23^{\circ}\text{C}) \times 3.5 \times 0.00098 = 0.54\text{L}$

In the above example, three liters of silicon oil is supplied.

 **CAUTION!**

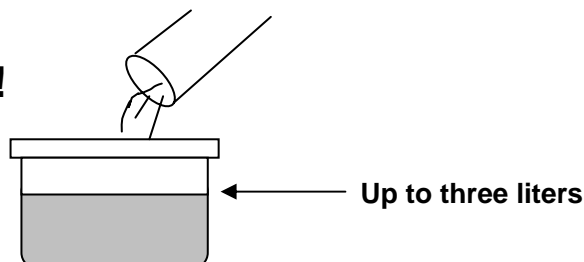

#### **Water/oil supply for in-bath**

The in-bath installed on the main body is removable for easy supply of water/oil. Be careful about the followings when supplying water/oil.

#### **Water supply for BM model water bath**

- Supply modest amount of water, considering overflow when sample flask is sunk into the bath.
- Wash the in-bath with water to keep it always clean. Remove the dirt on the in-bath, especially on the bottom surface of interior where the heater or temperature sensor contacts, before setup.
- Wipe the water droplet on the outer surface of in-bath completely before setup. If it is installed on the main body with water droplet remained, water splatter by heating of the heater or incorrect temperature detection may result in.
- Do not place flammable substances onto the installation area of heater. A fire disaster may result in.
- Clean the heater installation area frequently to keep it always clean. If not, malfunction of device or fire disaster may result in.
- **To clean in-bath, it was confirmed the bath not so hot, turn off the power switch and remove the power supply cord with plug.**

#### **Oil supply for BO model water bath**

- The amount of oil to be supplied is three liters at maximum. Supply modest amount of oil, considering overflow when sample flask is sunk into the bath.
- Wash the in-bath with mild detergent to keep it always clean. Remove the dirt on the in-bath, especially on the bottom surface of interior where the heater or temperature sensor contacts, before setup.
- Wipe the water droplet on the outer surface of in-bath completely and dry it before setup. If it is installed on the main body with water droplet remained, water splatter by heating of the heater or incorrect temperature detection may result in.
- Do not place flammable substances onto the installation area of heater. A fire disaster may result in.
- Clean the heater installation area frequently to keep it always clean. If not, malfunction of device or fire disaster may result in.
- **To clean in-bath, it was confirmed the bath not to so hot, turn off the power switch and remove the power supply cord with plug.**

#### **Handle with care.**



**Be careful about the amount of water/oil supplied.**

**Keep the bath and heater clean.**

**Do not spill fluid.**

### 3. Description and Function of Each Part

#### Main Unit

##### Front view

Outer covering  
Made by heat-resistant  
ABS resin

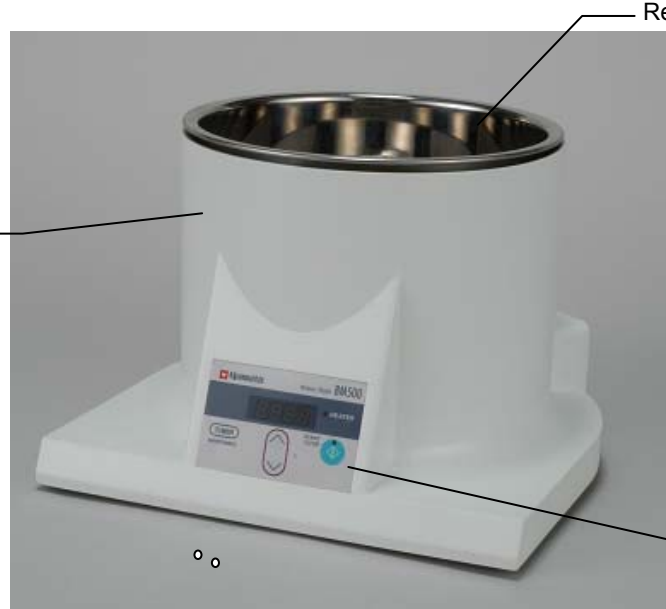

Removable in-bath (SUS316)

Control panel

##### Rear view

Connector for power cord



Power switch (circuit breaker)

Exclusive connector for bath operational setting function in rotary evaporator on the RE600/800 model.  
(The connecting cord is attached to the RE600/800 model.)

### 3. Description and Function of Each Part

#### Control Panel



Exclusive connector for bath operational setting function in rotary evaporator on the RE600/800 model.  
(The connecting cord is attached to the RE600/800 model.)

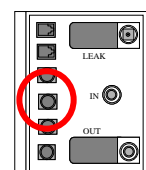











VR600/800  
Vacuum controller

No.	Name	Mark	Function
①	Preset temperature /measured temperature display screen	—	Usually displays bath temperature, and by key operation displays character or preset temperature.
②	HEATER lamp	HEATER	Lights up when heater is being operated.
③	UP key	▲	Increases the preset value.
④	Down key	▼	Decreases the preset value.
⑤	START/STOP key	START/STOP	Starts/stops the operation of device by pressing it for one minute.
⑥	Operation lamp	—	Lights up during fixed temperature operation and blinks during timer operation
⑦	TIMER key	TIMER	Operation setting key for quick auto stop, auto stop and auto start operation.
⑧	MAINTENANCE key	MAINTENANCE	Goes into the MAINTENANCE menu by pressing the TIMER key for a few seconds. MAINTENANCE menu selection/setting key, including the function of bath stop, heat-retention, key lock, calibration offset, reparation at power failure and accumulated time display.
⑨	Exclusive connector for operational setting function	—	Connected to the rotary evaporator on the RE600/800 model and detects abnormality in bath stop, heat-retention and bath temperature by instructions from RE main body at the end of operation when bath stop and heat-retention are selected with the MAINTENANCE key.

### 3. Description and Function of Each Part

#### Characters of the Controller

Indicated characters for BM/BO type controller are follows;

Character	Identifier	Name	Purpose
The characters on the timer selection screen			
	<b>AStP</b>	Selection/standby screen display for quick auto stop/auto stop timer operation	Selection screen for quick auto stop timer operation which stops the operation at preset time and quick auto stop function.
	<b>AStr</b>	Selection/waiting screen display for auto start timer operation	Selection screen for auto start timer operation which starts the operation at preset time.
The characters on the MAINTENANCE menu			
	<b>LoK</b>	Keylock of preset value	Selection menu to keylock the operation to disable the change of preset value. On: keylock/Off: cancels keylock
	<b>bSEt</b>	Selection screen for bath stop/heat-retention	Selection screen to switch the mode to stop the bath automatically or to retain heat by the signals from the RE main body at the completion of operation. Only available when the RE600/800 model rotary evaporator is connected.
	<b>StoP</b>	Selection screen for bath stop	Selection screen displayed when bath auto stop mode is selected. Only available when the RE600/800 model rotary evaporator is connected.
	<b>KEEP</b>	Selection screen for bath heat-retention	Selection screen displayed when bath auto heat-retention mode is selected. Only available when the RE600/800 model rotary evaporator is connected.
	<b>mnL</b>	Setting screen for bath stop/heat-retention (function disabling)	Selection screen displayed where the RE600/800 model rotary evaporator is not connected or bath is used separately. This screen is set at factory shipment.
	<b>Sv2</b>	Setting screen for heat-retention temperature	Setting screen to set heat-retention temperature of bath. Displayed when KEEP is selected in bSet. Only available when the RE600/800 model rotary evaporator is connected.
	<b>cAL</b>	Calibration offset setting	Indicates that calibration offset temperature input mode is selected.
	<b>Pon</b>	Selection screen for reparation at power failure	Selection screen to set the operational status of device after power failure. ON: recovers and continues operation. OFF: remains operation stop state. The setting is OFF at factory shipment.

\* Also refer to Page 176 "Operation Mode, Function Setting Key, and Characters".



## 4.Operation Method

### Operation Mode and Function List

The operation modes of this unit are as follows;

No.	Name	Description	Page
1	Fixed Temperature Operation	Set the desired temperature with the $\Delta \nabla$ keys. Press the START/STOP key for one second to start operation. Press the same key again to stop operation.	187
2	Quick Auto Stop Operation	Press the <b>TIMER</b> key during fixed temperature operation. Select the <b>ASET</b> and set the operating time with the $\Delta \nabla$ keys. Press the START/STOP key for one second to start the auto stop operation.	198
3	Auto Stop Operation	Press the <b>TIMER</b> key during standby time before operation. Select the <b>ASET</b> and set the operating time with the $\Delta \nabla$ keys. Press the START/STOP key for one second to start the auto stop operation.	20
4	Auto Start Operation	Press the <b>TIMER</b> key two times during standby time before operation. Select the <b>ASET</b> and set the operating time with the $\Delta \nabla$ keys. Press the START/STOP key for one second to start the auto start operation.	232

The safety features of the device are described below;

No.	Name	Description	Page
1	Overheating prevention device	<p>① Overheating prevention function: This function is set to be automatically activated(manual reset) when the temperature exceeds the setting temperature by 40°C. The "Er06" is displayed on the display screen when this function operates. In this case, turn off the breaker and call the service department. The device recovers after the cause of problem is removed and the circuit breaker is turned to on again.</p> <p>② Thermal fuse: The device contains a thermal fuse. The fuse works if the overheating prevention function mentioned in the above does not operate.</p>	24
2	Circuit breaker	The device has a power switch-type circuit breaker on the back surface of main body.	-

### Operation Mode and Function List

The maintenance functions of device are described as follows.

The maintenance mode shares the operation key with the timer function. Keep pressing the TIMER key for four seconds to go into the maintenance mode.

	Name	Description	Page
1	Keylock function	The function keylocks the preset temperature to disable its change during operation. Select “on” or “oFF” with the $\Delta\nabla$ key. “On” keylocks the preset value and “oFF” cancels the keylock.	265
2	Bath operation setting function (exclusive function available only when the RE600/800 model rotary evaporator is connected)	<p>The function is available only when the RE600/800 model rotary evaporator is connected. By interfacing with the vacuum controller on the main body of rotary evaporator, the function stops the bath automatically or keeps the bath in a state of heat-retention when the rotary evaporator completes the operation.</p> <p>Press the TIMER key in the maintenance mode to display the <span style="border: 1px solid black; padding: 2px;">bSEt</span> <span style="border: 1px solid black; padding: 2px;">n nL</span> alternant display screen.</p> <p>Select the <span style="border: 1px solid black; padding: 2px;">StOp</span> with the <math>\Delta\nabla</math> keys to automatically stop the bath when the rotary evaporator completes the operation.</p> <p>Select the <span style="border: 1px solid black; padding: 2px;">HEEP</span> with the <math>\Delta\nabla</math> keys to keeps the bath in a state of heat-retention when the rotary evaporator completes the operation.</p> <p>The setting at factory shipment is the <span style="border: 1px solid black; padding: 2px;">n nL</span> mode to disable the operation setting function.</p> <p>Setting of heat-retention temperature</p> <p>Select the <span style="border: 1px solid black; padding: 2px;">HEEP</span> and then press the TIMER key to set the heat-retention temperature. Set the desired value with the <math>\Delta\nabla</math> keys.</p>	26
	Calibration offset function	<p>The function corrects the temperature inside the bath by adjusting it to the preset temperature in case the temperature inside the bath does not reach or goes over the preset value. This function can match the values of preset temperature and temperature inside the bath.</p> <p>The function can correct the value to either plus or minus side within the whole thermal bandwidth of device.</p> <p>Press the TIMER key to display the <span style="border: 1px solid black; padding: 2px;">cAL</span>. Input the correction value. The bath temperature increases when a minus value is input. It decreases when a plus value is input.</p>	276
4	Reparation at power failure	<p>The function selects the operational state of bath at recovery after power failure.</p> <p>On: recovers and continues operation.</p> <p>OFF: remains operation stop.</p> <p>The setting at factory shipment is “OFF”.</p> <p>Select the <span style="border: 1px solid black; padding: 2px;">P on</span> with the TIMER key and then select the “on” or “oFF” with the <math>\Delta\nabla</math> keys.</p>	287

# 4. Operation Method

## Operation Mode, Function Setting Key, and Characters

The following key operations and characters are used for the settings of operation mode and functions.

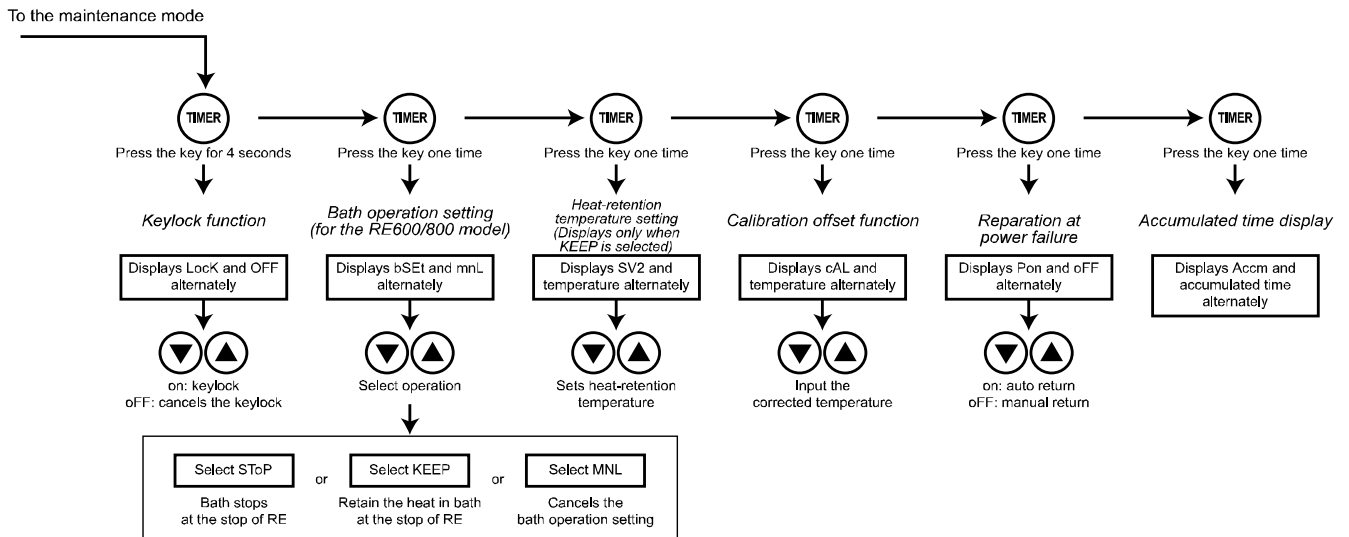
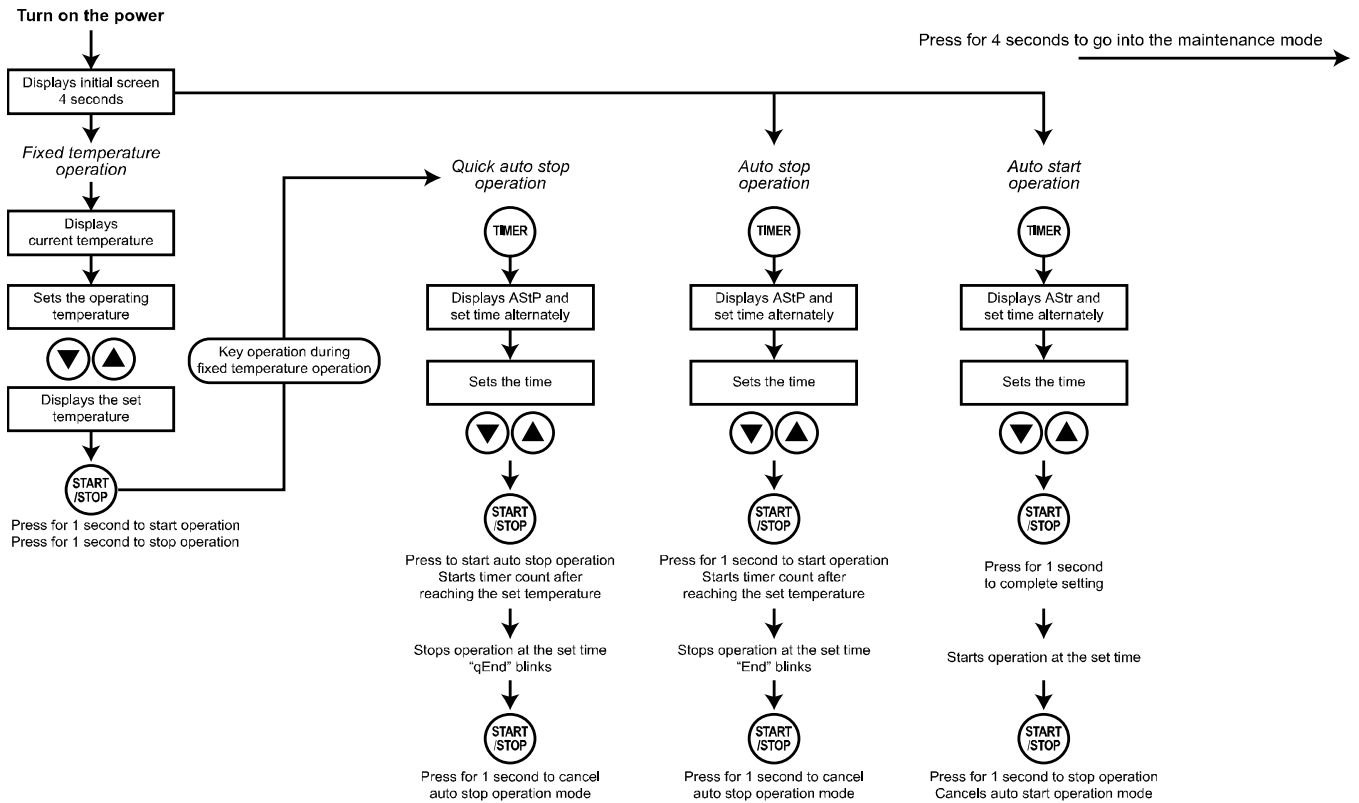

## Fixed Temperature Operation

Fix Temperature Operation is regular drive mode for continuous driving.

### Fixed temperature operation procedures

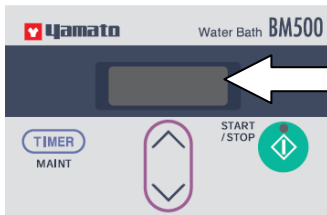

#### 1. Turn on the power switch (turn the breaker to ON)

- After the power switch on the back surface of main body is turned to on, the screen displays the initial values for about four seconds. After that the screen goes into the standby state. The indicator displays the current temperature inside the bath.

#### Screen for measured temperature/preset temperature:

The current temperature inside the bath is displayed without operation.

- ❖ Refer to the P.14 for the characters of operation mode.

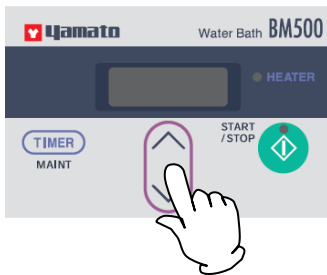

#### 2. Set the temperature

- Set the desired temperature with the  $\Delta$ / $\nabla$  keys. Press the  $\Delta$  key or  $\nabla$  key. The screen displays the preset temperature. Press the  $\Delta$  key to increase the value. Press the  $\nabla$  key to decrease the value. After three seconds the screen displays the current bath temperature.

**CAUTION:** When it adds some hot water while driven and the liquid temperature is made 40°C or more higher than the preset temperature, the device judges the temperature anomaly, intercepts the heating circuit, and displays error 6. When it will add some hot water, please cancel the drive.

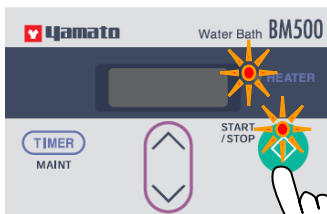

#### 3. Start operation

- Press the START/STOP key for about one second. The device starts operation. The operation lamp lights up. The HEATER lamp lights up and the temperature begin to increase.



#### 4. Stop operation

- Press the START/STOP key for about one second. The device stops operation. The operation lamp lights off. The HEATER lamp lights off. The screen displays the current bath temperature.

### To correct the setting mistake or check the preset value...

Press the  $\Delta$ / $\nabla$  key again to correct the setting mistake or to check the preset value. The screen changes to the preset temperature screen to display it.

### To change the preset temperature during operation...

Press the  $\Delta$ / $\nabla$  key during operation to change the preset temperature during operation. The device goes into the setting mode where the preset temperature is possible to be changed. After the setting with the  $\Delta$ / $\nabla$  keys, the device continues operation with the new preset temperature.

## 4. Operation Method

### Quick Auto Stop Operation

Quick Auto Stop Operation is driving mode for adding auto stop timer during fix temperature operation.

#### Quick auto stop operation procedures



#### 1. Turn on the power switch (turn the breaker to ON)

- After the power switch on the back surface of main body is turned to on, the screen displays the initial values for about four seconds. After that the screen goes into the standby state. The indicator displays the current temperature inside the bath.

**Screen for measured temperature/preset temperature:**  
The current temperature inside the bath is displayed without operation.

- ❖ Refer to the P.14 for the characters of operation mode.

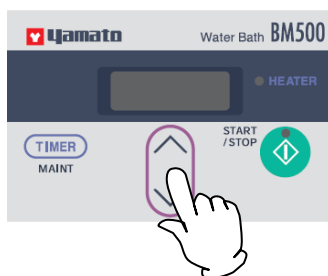

#### 2. Set the temperature

- Set the desired temperature with the  $\Delta$ / $\nabla$  keys.  
Press the  $\Delta$  key or  $\nabla$  key. The screen displays the preset temperature. Press the  $\Delta$  key to increase the value. Press the  $\nabla$  key to decrease the value.  
After three seconds the screen displays the current bath temperature.

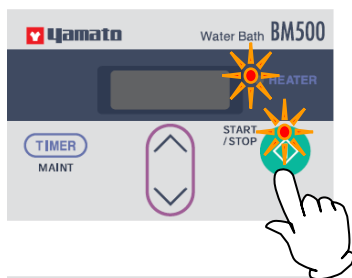

#### 3. Start operation

- Press the START/STOP key for about one second.  
The device starts operation. The operation lamp lights up. The HEATER lamp lights up and the temperature begin to increase.

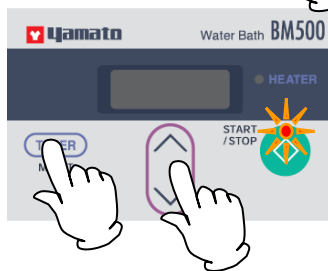

#### 4. Set the auto stop timer

- Press the TIMER key.  
The screen displays "AstP" and the time alternately.  
Set the auto stop time with the  $\Delta$ / $\nabla$  keys.

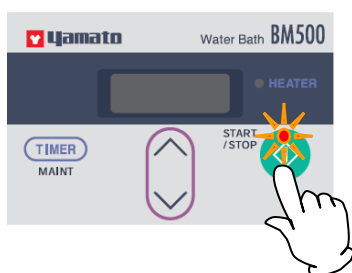

#### 5. Start the timer operation

- Press the START/STOP key.  
The operation lamp slowly blinks and auto stop operation begins.

When the bath temperature is reached to preset temperature, the time is counted and timer operation will start.

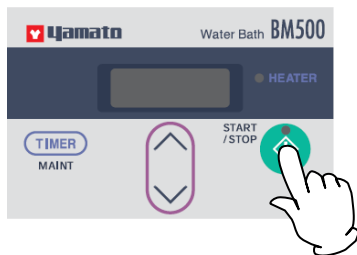

#### 6. Stop operation

- Press the START/STOP key for about one second.  
The device stops operation. The operation lamp lights off.  
The HEATER lamp lights off.  
The screen displays the current bath temperature.

#### To correct the setting mistake or check the preset value...

Press the  $\Delta\nabla$  key again to correct the setting mistake or to check the preset value.  
The screen changes to the preset temperature screen to display it.

#### To change the preset temperature during operation...

Press the  $\Delta\nabla$  key during operation to change the preset temperature during operation. The device goes into the setting mode where the preset temperature is possible to be changed. After the setting with the  $\Delta\nabla$  keys, the device continues operation with the new preset temperature.

#### To change the Timer count during operation...

Press the timer key during operation to change the timer count during operation. The device goes into the setting mode where the timer is possible to be changed. After the setting with the  $\Delta\nabla$  keys, the device continues operation with the new timer. If the timer is changed, please set time longer than already passed time in changing.

# 4. Operation Method

## Auto Stop Operation

Auto Stop Operation is driving mode for stop drive when to reach preset time.  
Set the Auto Stop Operation before driving.

### Auto stop operation procedures

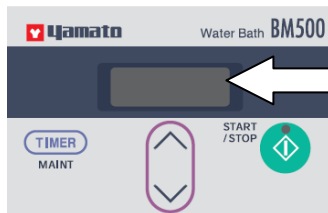

#### 1. Turn on the power switch (turn the breaker to ON)

- After the power switch on the back surface of main body is turned to on, the screen displays the initial values for about four seconds. After that the screen goes into the standby state. The indicator displays the current temperature inside the bath.

**Screen for measured temperature/preset temperature:**  
The current temperature inside the bath is displayed without operation.

- ❖ Refer to the P.14 for the characters of operation mode.

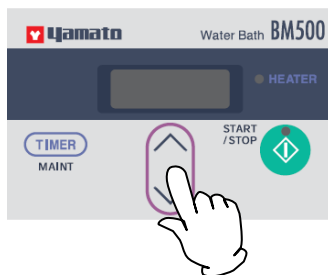

#### 2. Set the temperature

- Set the desired temperature with the  $\Delta$ / $\nabla$  keys. Press the  $\Delta$  key or  $\nabla$  key. The screen displays the preset temperature. Press the  $\Delta$  key to increase the value. Press the  $\nabla$  key to decrease the value. After three seconds the screen displays the current bath temperature.

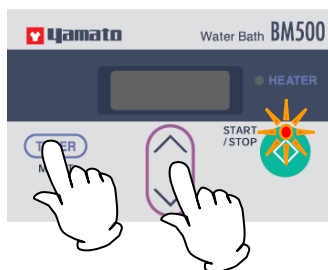

#### 3. Set the auto stop timer

- Press the TIMER key and select the "AstP". The screen displays "AstP" and the time alternately. Set the auto stop time with the  $\Delta$ / $\nabla$  keys.

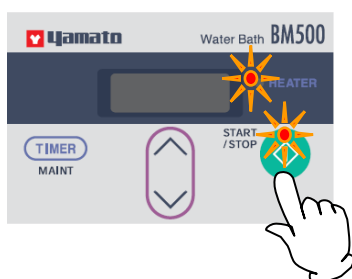

#### 4. Start operation

- Press the START/STOP key for about one second. The device starts operation. The operation lamp lights up. The HEATER lamp lights up and the temperature begin to increase. Timer count starts after the bath temperature reaches the preset temperature.



#### 5. End of operation

- The device automatically stops operation at the preset time. The screen displays the current bath temperature. The HEATER lamp lights off.

Present temperature and Rest time are alternately displayed on the screen.

**To correct the setting mistake or check the preset value...**

Press the  $\Delta\nabla$  key again to correct the setting mistake or to check the preset value.  
The screen changes to the preset temperature screen to display it.

**To change the preset temperature during operation...**

Press the  $\Delta\nabla$  key during operation to change the preset temperature during operation. The device goes into the setting mode where the preset temperature is possible to be changed. After the setting with the  $\Delta\nabla$  keys, the device continues operation with the new preset temperature.

**To change the Timer count during operation...**

Press the timer key during operation to change the timer count during operation. The device goes into the setting mode where the timer is possible to be changed. After the setting with the  $\Delta\nabla$  keys, the device continues operation with the new timer. If the timer is changed, please set time longer than already passed time in changing.



# 4. Operation Method

## Auto Start Operation

Auto Start Operation is timer driving mode for start drive when to reach preset time.  
Set the Auto Start Operation before driving.

### Auto start operation procedures

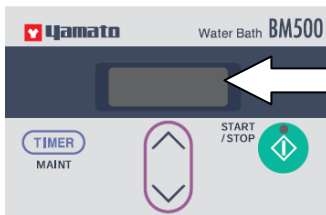

#### 1. Turn on the power switch (turn the breaker to ON)

- After the power switch on the back surface of main body is turned to on, the screen displays the initial values for about four seconds. After that the screen goes into the standby state. The indicator displays the current temperature inside the bath.

**Screen for measured temperature/preset temperature:**  
The current temperature inside the bath is displayed without operation.

- ❖ Refer to the P.14 for the characters of operation mode.

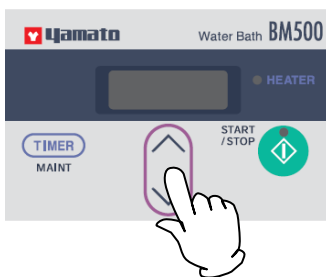

#### 2. Set the temperature

- Set the desired temperature with the  $\Delta$ / $\nabla$  keys. Press the  $\Delta$  key or  $\nabla$  key. The screen displays the preset temperature. Press the  $\Delta$  key to increase the value. Press the  $\nabla$  key to decrease the value. After three seconds the screen displays the current bath temperature.

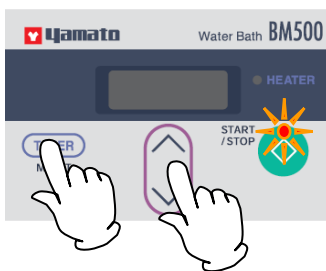

#### 3. Set the auto start timer

- Press the TIMER key and select the "AstP". The screen displays "AstP" and the time alternately. Set the auto start time with the  $\Delta$ / $\nabla$  keys.

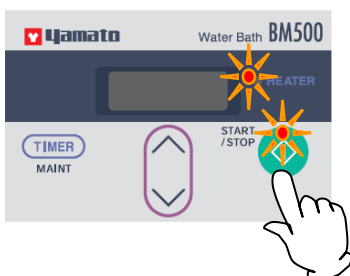

#### 4. Start operation

- Press the START/STOP key for about one second. The device starts operation. The operation lamp blinks. The HEATER lamp lights up and the temperature begin to increase at the preset time.

Present temperature and Rest time are alternately displayed on the screen.

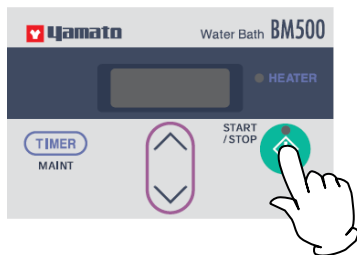

#### 5. Stop operation

- Press the START/STOP key for about one second.  
The device stops operation. The operation lamp lights off.  
The HEATER lamp lights off.  
The screen displays the current bath temperature.

#### To correct the setting mistake or check the preset value...

Press the  $\Delta$ / $\nabla$  key again to correct the setting mistake or to check the preset value.  
The screen changes to the preset temperature screen to display it.

#### To change the preset temperature during operation...

Press the  $\Delta$ / $\nabla$  key during operation to change the preset temperature during operation. The device goes into the setting mode where the preset temperature is possible to be changed. After the setting with the  $\Delta$ / $\nabla$  keys, the device continues operation with the new preset temperature.

#### To change the Timer count during operation...

Press the timer key during operation to change the timer count during operation. The device goes into the setting mode where the timer is possible to be changed. After the setting with the  $\Delta$ / $\nabla$  keys, the device continues operation with the new timer. If the timer is changed, please set time longer than already passed time in changing.

### Setting of Overheating Prevention Device

The safety device for overheating prevention also includes the automatic overheating prevention function (manual return) of controller. The device also contains a thermal fuse to set the operating temperature to 128°C(for BM500 and 510 models) or to 192°C(for BO400 and 410 models) for double safety function.

#### Setting range and functions of overheating prevention on the controller

The controller on the device has the overheating prevention function. It has been set, at factory shipment, so the function automatically works at the temperature of "preset temperature plus 40°C".

If the temperature inside the bath continues to increase over the preset temperature of controller and reaches the temperature at which the overheating prevention function works, the circuit is cut off and the controller screen displays "Er06". **The device recovers after the cause of problem is removed and the circuit breaker is turned to on again.**

#### Caution:

- **When it adds some hot water while driven and the liquid temperature is made 40°C or more higher than the preset temperature, the device judges the temperature anomaly, intercepts the heating circuit, and displays error 6. When it will add some hot water, please cancel the drive.**
- The device may be defective if the overheating prevention device or thermal fuse operates. In this case, disconnect the power cord immediately and call the service department of our selling office or sales office.
- The overheating prevention function is intended to prevent the abnormal overheating of device. It is not intended to protect the sample, or to prevent the accidents caused by the use of explosive or flammable substances.

#### When power failure occurs...

- For safety, the device stops operation and keeps operation standby state when a power failure occurs.

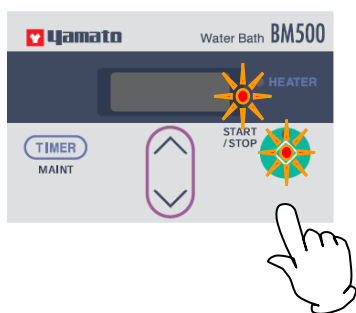

- Press the START/STOP key for about one second to re-start the operation.
- Select "on" in the "Pon" (reparation function at power failure) of the MAINTENANCE menu for automatic return using this function. In this case do not perform unmanned operation for safety reason. Refer to the page 287.

### Use Keylock Function

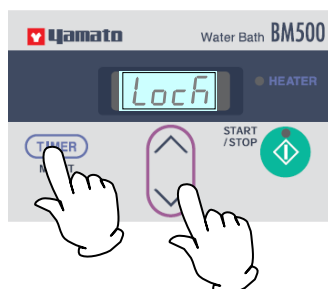

This function keylocks the operating state of device. Use the **TIMER** key to set or cancel the function.

- ① Press the **TIMER** key for about four seconds. Select the "Lock" which indicates operation keylock.
- ② The screen displays the "Lock" and "off" alternately. Select "on" with the  $\Delta$  key to lock the preset value.
- ③ Select "off" with the  $\nabla$  key to unlock the setting.
  - ❖ When the function is set to "on", all keys other than the **TIMER** key are locked.

## Bath Operation Setting Function

The function is available only when the RE600/800 model rotary evaporator is connected.

Connect the connector on the back surface of vacuum controller at RE and connector on the back surface of bath using the exclusive connection cable attached to the RE600/800 model. Refer to the instruction manual of VR600/VR800 for the details.

### Bath operation setting

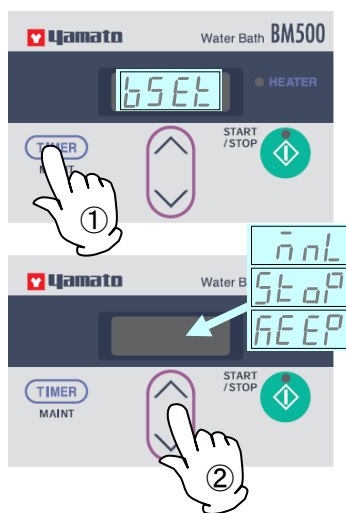

- By the signals from/to the vacuum controller on the main body of rotary evaporator, the function stops the bath or keeps the bath in heat-retention state when the rotary evaporator completes the operation.

- ① Press the **TIMER** key for about four seconds and then press it few times to display the "bSEt"/"mnL" alternant display screen.
- ② Select the "StoP" with the  $\Delta$  $\nabla$  keys to automatically stop the bath when the rotary evaporator completes the operation.
- ③ Select the "KEEP" with the  $\Delta$  $\nabla$  keys to automatically keeps the bath in a state of heat-retention when the rotary evaporator completes the operation.
  - ❖ The setting at factory shipment is the "mnL" mode to disable the operation setting function.

### Heat-retention temperature setting

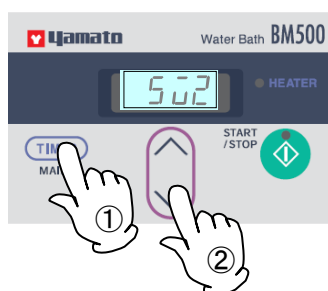

- Set the heat-retention temperature when the "KEEP" is selected. Press the MAINTENANCE key to display the "Sv2", then input the desired value for heat-retention temperature.

## Calibration Offset Function

### Use Calibration Offset Function

The calibration offset function corrects the difference between the temperature inside the bath actually measured using the thermometer or temperature recorder and the temperature controlled by the controller on the main body (temperature controller) to match them. Input a plus value by the difference when the temperature inside the bath is higher than the preset value. Input a minus value by the difference when the temperature inside the bath is lower than the preset value. Use the MAINTENANCE key to set or cancel the function. "0" is set at factory shipment.

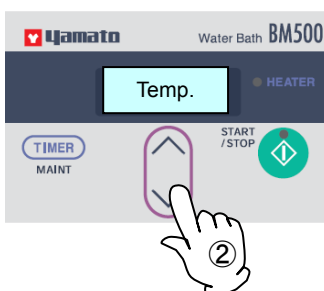
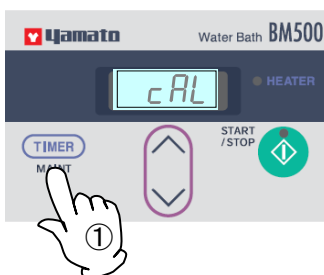
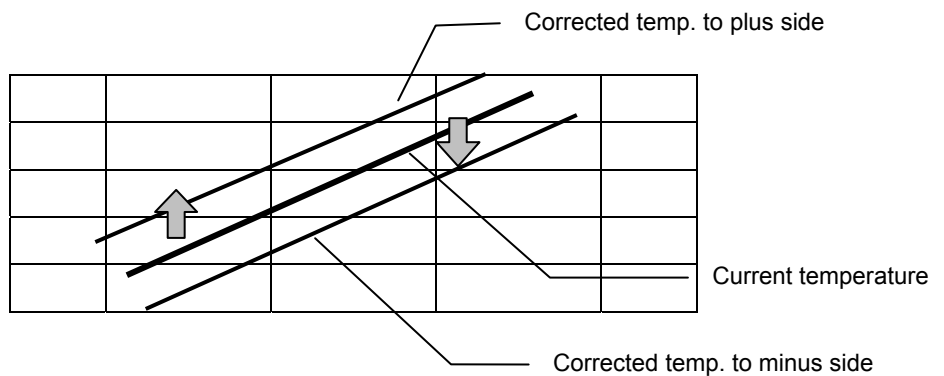

- ① Start the operation with the target preset temperature. After the temperature has been stable, measure it with the temperature recorder.
- ② Check the difference between the preset temperature and actual temperature inside the bath.
- ③ Press the TIMER key for about four seconds and then press it few times to select the "cAL".
- ④ The screen displays the "cAL" and correction temperature screen. Input the difference with the  $\Delta$ / $\nabla$  keys while the digit is blinking. This completes the setting.

- ❖ The setting range of offset correction temperature is plus side and minus side respectively. When it is set to the minus side, the temperature on the measurement temperature display screen falls by the setting temperature, while the temperature on bath rises. When it is set to the plus side, the temperature on the measurement temperature display screen rises by the setting temperature, while the temperature on bath falls.

## 4.Operation Method

### Reparation Function at Power Failure

This function selects the operating state of bath at recovery, **auto returning or stop status** after power failure. The setting at factory shipment is "OFF".

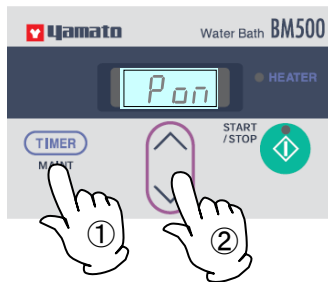

Press the TIMER key for about four seconds and then press it few times to select the "Pon". Select "on" or "oFF" with the  $\Delta$ / $\nabla$  keys.

On: continues operation after recovery.

OFF: remains operation stop.

**Caution:**

Do not perform unmanned operation for safety reason when "on" has been set.

## 5. Handling Precautions



### 1. Substances that cannot be used



Never use explosive substances, flammable substances and substances that include explosive or flammable ingredients in this unit. Explosion or fire may occur. (Refer to page 40 "List of Dangerous Substances".)

### 2. Do not perform unmanned operation



For safety reason, do not perform unmanned operation of the devices that requires oil. There is a danger of ignition to oily smoke that may cause fire disaster.

### 3. Install exhauster (ventilator) and extinguisher



There is a danger of fire disaster. Be sure to install an exhauster, ventilator and extinguisher around the device.  
Silicon oil also may generate harmful gas. Be sure to install an exhauster, ventilator and extinguisher around the device.

### 4. If a problem occurs



If smoke or strange odor should come out of this unit for some reason, turn off the power key right away, and then turn off the circuit breaker and the main power. Immediately contact a service technician for inspection. If this procedure is not followed, fire or electrical shock may result. Never perform repair work yourself, since it is dangerous and not recommended.



### 1. Do not step on this unit



Do not step on this unit. It will cause injury if this unit fall down or break.

### 2. Do not place or drop anything on the unit



Do not place or drop anything on the unit. Since the unit contains precision components, it may malfunction due to vibration, impact, etc.

### 3. During a thunder storm



During a thunderstorm, turn off the power switch immediately, then turn off the main power. If this procedure is not followed, fire or electrical shock may be caused.

### 4. Countermeasure for stop operation during night or long-term stop



In case of stopping operation during night or long-term, toggle the power switch to "OFF".

## 5. Applicable oil



Use ion-exchange water or exchange water diligently for the BM model water bath to prevent the accumulation of boiling scale or calculus.

Do not use the fluid other than specified silicon oil for the BO model oil bath. Use the specified silicon oil. Periodically change the oil and clean the bath. Refer to page 10.



## 6.Maintenance Method

### Daily Inspection and Maintenance

---

For the safety use of this unit, please perform the daily inspection and maintenance without fail.

#### **WARNING!**

- Be sure to disconnect the power cord during inspection or maintenance of device.
- Wipe water or oil on or around the operating panel and heater completely to prevent ground leakage and electric shock.
- Do not drain the device until temperature of the water/oil inside the sample bath falls to 45°C or below.
- Do not disassemble the device.

#### **CAUTION!**

- Wipe the dirt on the outer covering with soft cloth wrung out with mild detergent. Do not use benzene, thinner or cleanser, or do not scrub it with a scrubbing brush. Deformation, deterioration or discoloration may result in.
- Wipe the dirt, droplet and oil content on the in-bath with a dry cloth.
- Be careful not to damage the heater and sensor.

---

For any questions, contact the dealer who you purchased this unit from, or the nearest sales division in our company.

## 7. Long storage and disposal

### When not using this unit for long term / When disposing

#### **CAUTION!**

##### When not using this unit for long term...

- Turn off the power and disconnect the power cord.
- Drain the oil/water inside the bath and wipe it completely.

#### **WARNING!**

##### When disposing...

- Drain the oil completely when disposed.
- Keep out of reach of children.
- Dispose as a bulky garbage

### Environmental protection should be considered

We request you to disassemble this unit as possible and recycle the reusable parts considering to the environmental protection. The feature components of this unit and materials used are listed below.

Component Name	Material
<b>Exterior Parts</b>	
Outer covering	Heat-resistant ABS resin, resin coating
Inner bath	Stainless steel SUS316
Heat insulation material	Rockwool
Plates	PET resin film
Rubber foot	Chloroprene rubber
<b>Electrical Parts</b>	
Switches, Relay	Composite of resin, copper and other
Circuit boards	Composite of glass fiber and other
Pipe heater	Inconel
Power cord	Composite of synthetic rubber coated wiring materials, copper, nickel and other

## 8.In the Event of Failure...

### Safety Device and Error Code

The error messages displayed on the controller are as follows.

The device stops heater output and notifies the users of abnormality by indicating the corresponding error code. Record the code and turn off the power, then call the service department of our company.

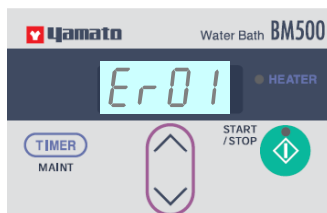

Error Code		Cause/Solution	
Er01	Er01	Abnormality in temperature sensor	Disconnection/removal of temperature sensor or defect in temperature controller is considered. Check/replace the sensor. Reset the power to correct the error.
Er06	Er06	Temperature anomaly	Overheating prevention device activated. Overheating prevention device activated. Error in temperature control is considered, or the temperature inside the bath is 40 °C higher than the preset temperature. Reset the power to correct the error. <b>If it is not correct the error, it need to exchange the control board.</b>
Er15	Er15	Abnormality in memory	Error in preset value memorized. Replace the substrate.
Nondisplay		Disconnection in thermal fuse	Disconnection of thermal fuse is considered. Call the service department. Replace the thermal fuse.

## 8.In the Event of Failure...

### Trouble Shooting

Phenomenon	Check point
Device does not start after turning on the power switch.	<ul style="list-style-type: none"><li>• Check if the power cable is securely connected to the receptacle.</li><li>• Check if a power failure occurs.</li><li>• <b>Check if amount of water or oil are little.</b></li></ul>
Circuit breaker trips.	<ul style="list-style-type: none"><li>• Check if the device is wet with water.</li><li>• Short-circuit (call the service department.)</li></ul>
Er06 lights up.	<ul style="list-style-type: none"><li>• Check if the preset temperature of controller is lower than the temperature inside the bath.</li></ul>
Temperature does not fall.	<ul style="list-style-type: none"><li>• Check if the preset value is higher than the temperature inside the bath.</li></ul>
Too high/low measured temperature	<ul style="list-style-type: none"><li>• It is likely not to stabilize in the heating immediately after turning on of the power supply.</li><li>• Check if an incorrect value is input for the temperature of calibration offset. (Refer to P.27.)</li><li>• Check if the temperature sensor inside the bath is dirty, or if it correctly contacts with the bottom surface inside the bath.</li></ul>

In the case if the error other than listed above occurred, turn off the power switch and primary power source immediately. Contact the shop of your purchase or nearest Yamato Scientific Service Office.

#### In Case of Request for Repair

If the failure occurs, stop the operation, turn OFF the power switch, and unplug the power plug. Please contact the sales agency that this unit was purchased, or the Yamato Scientific's sales office.

#### < Check following items before contact >

- ◆ Model Name of Product
  - ◆ Production Number
  - ◆ Purchase Date
  - ◆ About Trouble (in detail as possible)
- } See the production plate attached to this unit.

Be sure to indicate the warranty card to our service representative.

#### Warranty card (attached separately)

- ◆ Warranty card is given by your dealer or one of our sales offices and please fill in your dealer, date of purchase and other information and store securely.
- ◆ Warranty period is one full year from the date of purchase. Repair service for free is available according to the conditions written on the warranty card.
- ◆ For repairs after the warranty period consult your dealer or one of our sales offices. Paid repair service is available on your request when the product's functionality can be maintained by repair.

#### Minimum Retention Period of Performance Parts for Repair

The minimum retention period of performance parts for repair of this unit is 7 years after discontinuance of this unit.

The "performance part for repair" is the part that is required to maintain this unit.

## 10.Specification

Product Name	Water Bath		Oil Bath	
Model	BM500	BM510	BO400	BO410
Bath capacity	Approx. 4 liters (Amount of water/oil filled at 30 mm from the upper edge of in-bath)			
Effective bath capacity	Approx. 4 liters			
Bath material	SUS316			
Temperature control range	Room temp.+5°C~90°C		Room temp.+5°C~180°C	
Temperature setting range	0°C~100°C		0°C~180°C	
Temperature adjustment accuracy*	±1.5°C (at agitation)		±2°C (at agitation)	
Temperature control system	PID control			
Temperature setting system	Digital setting by $\Delta$ $\nabla$ keys			
Minimum range for temperature setting	1°C			
Temperature display system	Digital 7segments LED			
Sensor	K-thermocouple			
Heater	100V: 1000W 120V: 1440W	200V: 1000W 240V: 1440W	100V: 1000W 120V: 1440W	200V: 1000W 240V: 1440W
Safety functions	Self-diagnostic function, <b>Abnormality in temperature sensor</b> , Keylock function, Reparation function at power failure, Overheating prevention (manual return at the temperature of "preset temperature plus 40°C)", Thermal fuse, Micro switch to detect heating without water/oil, <b>Circuit protector</b>			
Functions	Fixed temperature operation, Quick auto stop operation, Auto stop operation, Auto start operation, Operation lamp, Maintenance function (selects operation, stop, or heat-retention, operating with the RE600/800 model)			
External dimensions	Approx. 340W × 349D × 231H (Height of in-bath: H)			
Dimensions of bath	Approx. 263W × 124H (bottom diameter: $\phi$ 165)			
Weigh	約 5.5 kg			
Power supply	100V AC, 10.5A 120V AC, 12.5A	200V AC, 5.5A 240V AC, 6.5A	100V AC, 10.5A 120V AC, 12.5A	200V AC, 5.5A 240V AC, 6.5A
Accessory	Instruction manual, Warranty cord, Bowl, Power supply cord			

\* The performance under the power supply condition of AC 100V, 120V, 200V and 240V, room temp. 23°C±5°C, humidity 65%RH±20%, are shown here. The usable ambient temperature of the unit is from 5°C to 35°C

\* The silicon oil TSF485-50, made by Toshiba Silicon Co., Ltd., is used to measure the accuracy of temperature control for the BO model.

\* Protuberances does not contain in dimensions.

# 11. Wiring Diagram

## BM500/510

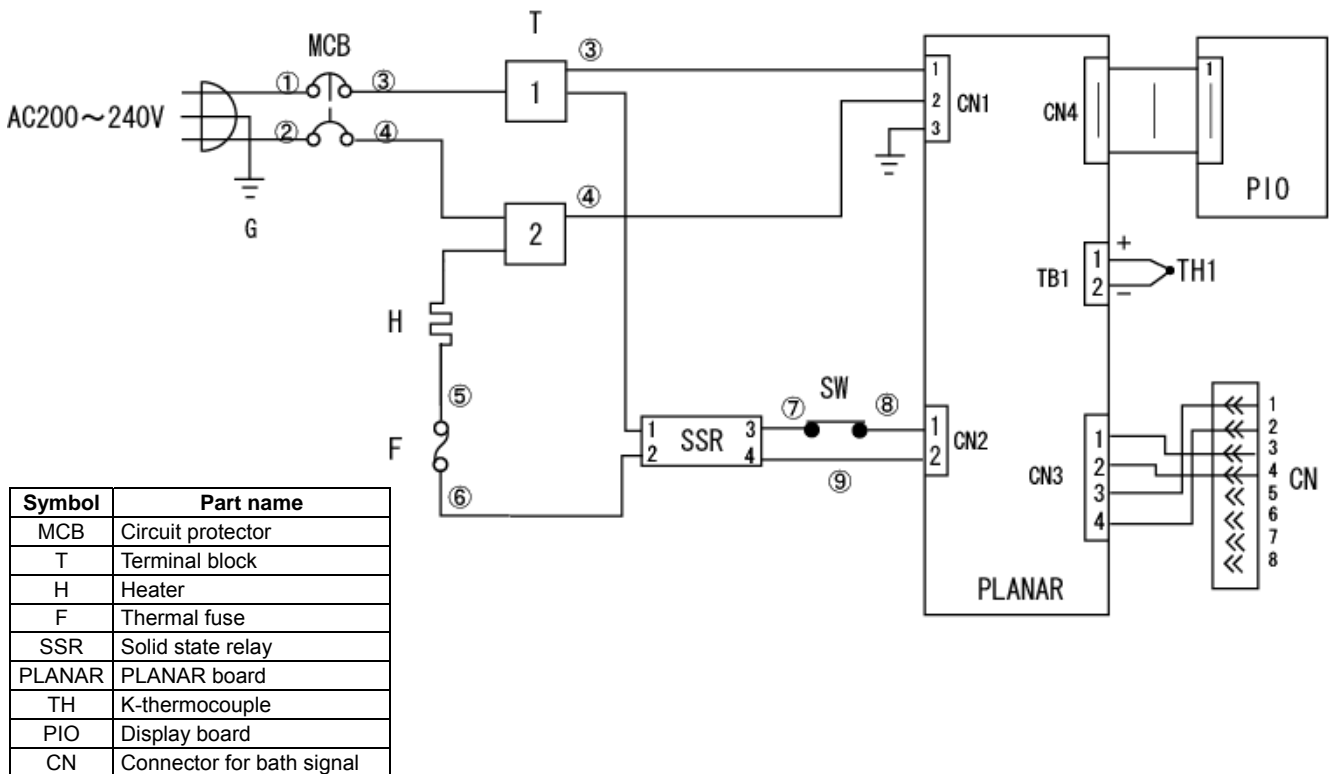
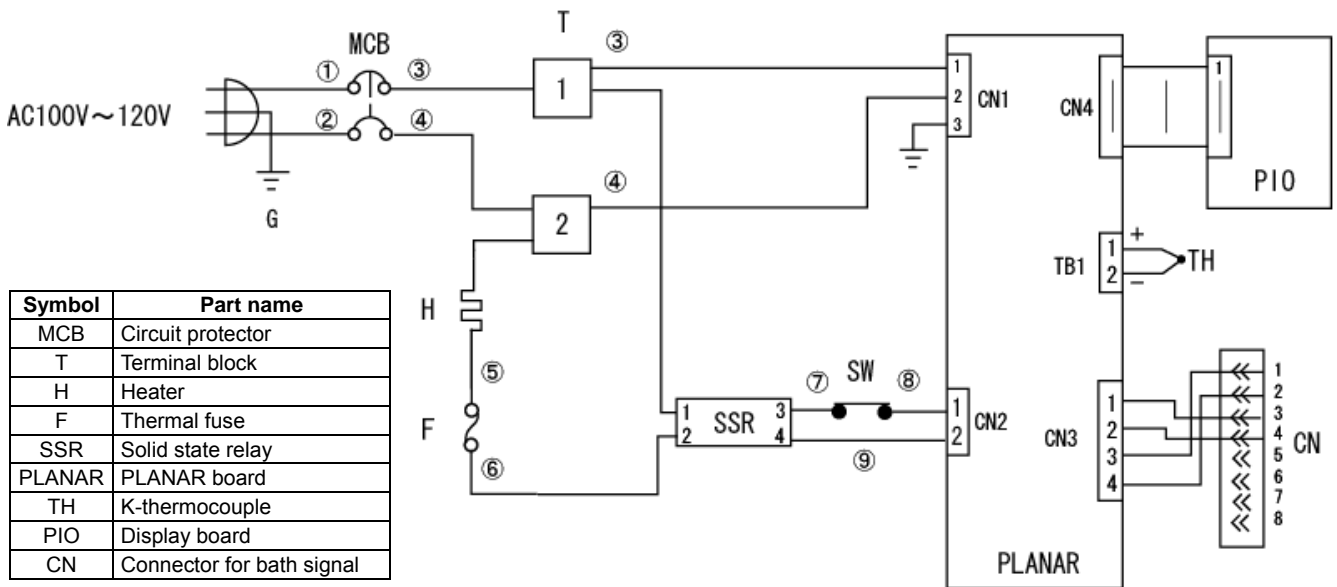

# 11. Wiring Diagram

## BO400/410

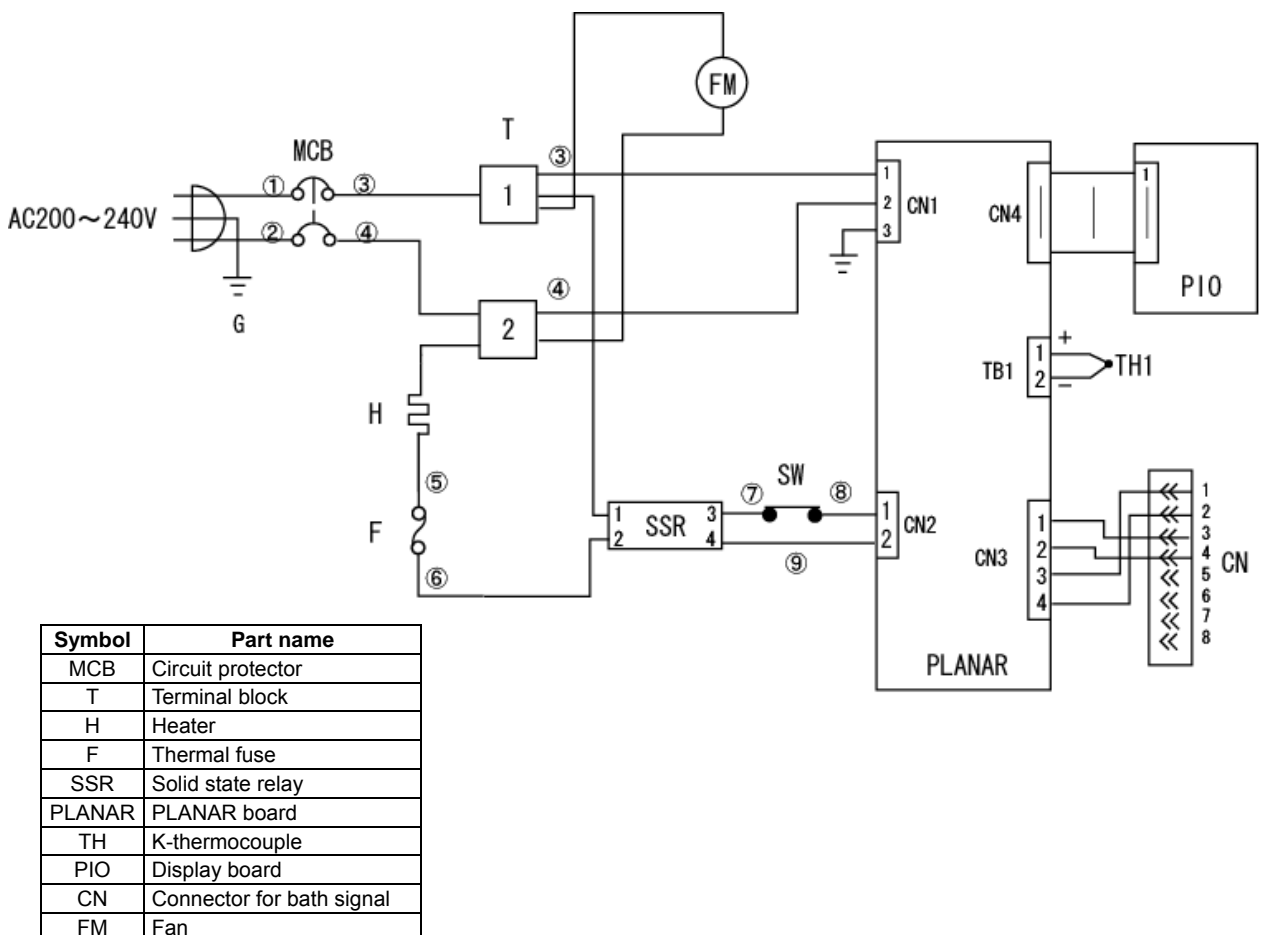
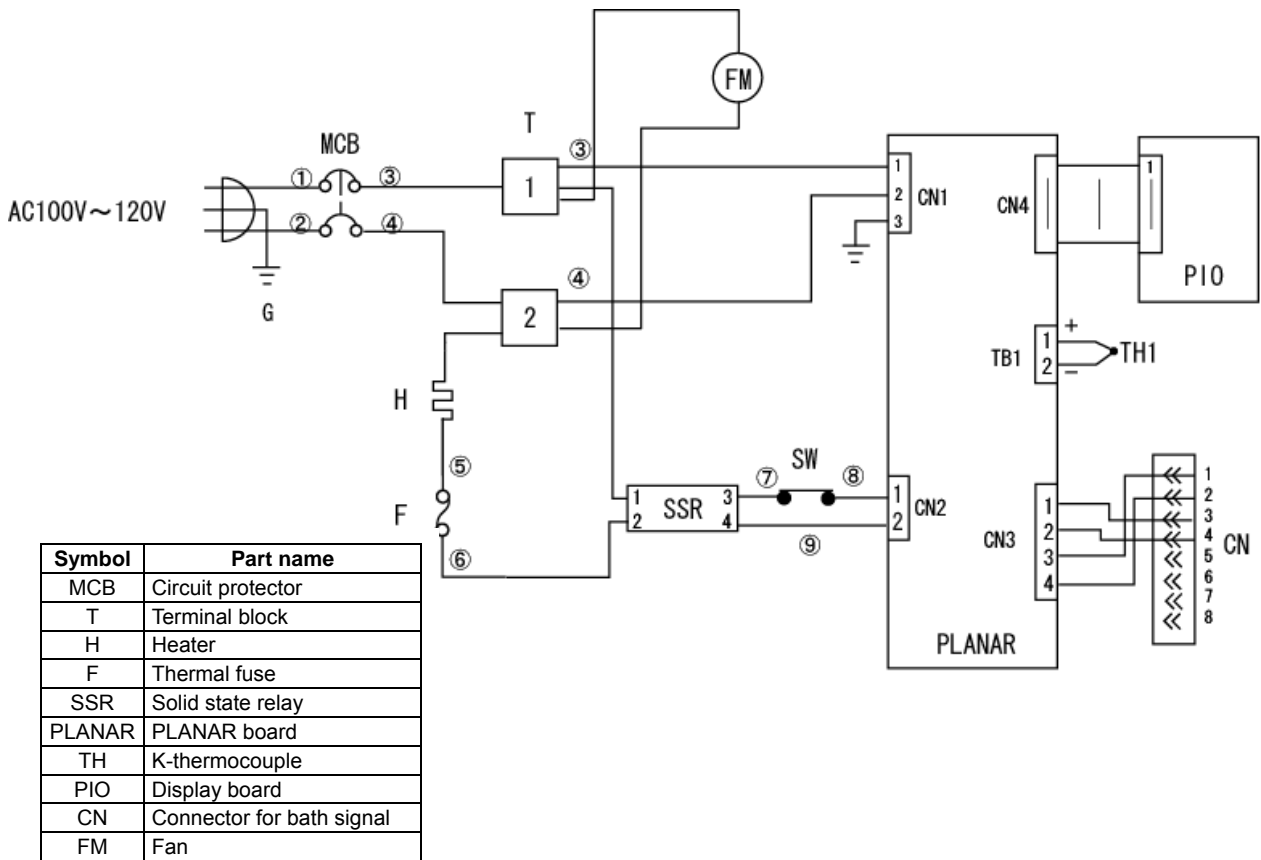



## 12.Replacement Parts Table

### Common parts for all models

Part Name	Code No.	Specification	Manufacturer
Micro switch to detect heating without water/oil	LT00015305	D2VW-01L1-1M	OMRON
SSR	LT00014941	S5C-225MV-(S)	Toho Denshi
PLANAR board	LT00013602	BM/BO PLANAR board	Yamato Scientific
Display board	LT00013603	BM/BO display board	Yamato Scientific
Sensor	LT00026845	BM/BO K-thermocouple	Yamato Scientific
Pillar fitting	LT00012102	Φ15×L20 M4	Yamato Scientific

### For BM500

Part Name	Code No.	Specification	Manufacturer
Thermal fuse	LT00015311	128°C E4A50128C	Sakaguchi Dennetsu
Heater	LT00028682	120V 1440W	Yamato Scientific
Circuit breaker	A0140046	100-120V BAM215031 15A	Panasonic
Power supply cable	LT00034726		Yamato Scientific

### For BM510

Part Name	Code No.	Specification	Manufacturer
Thermal fuse	LT00015311	128°C E4A50128C	Sakaguchi Dennetsu
Heater	LT00028683	240V 1440W	Yamato Scientific
Circuit breaker	LT00014955	BAM210031 10A	Panasonic
Power supply cable	LT00024798		Yamato Scientific

### For BO400

Part Name	Code No.	Specification	Manufacturer
Thermal fuse	LT00014938	192°C E4A50192C	Sakaguchi Dennetsu
Heater	LT00028682	120V 1440W	Yamato Scientific
Cooling fan for BO400	LT00014943	UF60D-AC115V	AUTONICS
Circuit breaker	A0140046	BAM215031 15A	Panasonic
Power supply cable	LT00034726		Yamato Scientific

### For BO410

Part Name	Code No.	Specification	Manufacturer
Thermal fuse	LT00014938	192°C E4A50192C	Sakaguchi Dennetsu
Heater	LT00028683	240V 1440W	Yamato Scientific
Cooling fan for BO410	LT00014954	UF60D-AC230V	AUTONICS
Circuit breaker	LT00014955	BAM210031 10A	Panasonic
Power supply cable	LT00024798		Yamato Scientific

## List of Dangerous Substances



Never use explosive substances, flammable substances and substances that include explosive or flammable ingredients in this unit.

## EXPLOSIVE

<b>EXPLOSIVE:</b>	Ethylene glycol dinitrate (nitro glycol), Glycerin trinitrate (nitroglycerine), Cellulose nitrate (nitrocellulose), and other explosive nitrate esters
	Trinitrobenzene, Trinitrotoluene, Trinitrophenol (picric acid), and other explosive nitro compounds
	Acetyl hydroperoxide (peracetic acid), Methyl ethyl ketone peroxide, Benzyl peroxide, and other organic peroxides

## FLAMMABLE

<b>IGNITING:</b>	Lithium (metal), Potassium (metal), Sodium (metal), Yellow phosphorus, Phosphorus sulfide, Red phosphorus, Celluloid compounds, Calcium carbide, Lime phosphate, Magnesium (powder), Aluminum (powder), Powder of metals other than magnesium and aluminum, Sodium hydrosulfite
<b>OXIDIZING:</b>	Potassium chlorate, Sodium chlorate, Ammonium chlorate, and other chlorate
	Potassium perchlorate, Sodium perchlorate, Ammonium perchlorate, and other perchlorate
	Potassium peroxide, Sodium peroxide, Barium peroxide, and other inorganic peroxide
	Potassium nitrate, Sodium nitrate, Ammonium nitrate, and other nitrate
	Sodium chlorite and other chlorites
	Calcium hypochlorite and other hypochlorites
<b>INFLAMMABLE LIQUID:</b>	Ethyl ether, Gasoline, Acetaldehyde, Propylene chloride, Carbon disulfide, and other flammable substances having a flash point of lower than -30°C
	Normal hexane, ethylene oxide, acetone, benzene, methyl ethyl ketone, and other flammable substances having a flash point of -30°C or higher but lower than 0°C
	Methanol, Ethanol, Xylene, Pentyl acetate (amyl acetate), and other flammable substances having a flash point of 0°C or higher but lower than 30°C
	Kerosene, Light oil (gas oil), Oil of turpentine, Isopentyl alcohol (isoamyl alcohol), Acetic acid, and other flammable substances having a flash point of 30°C or higher but lower than 65°C
<b>FLAMMABLE GAS:</b>	Hydrogen, Acetylene, Ethylene, Methane, Propane, Butane, and other flammable substances which assume a gaseous state at 15°C and 1 atm

(Source: Appendix Table 1 of Article 6 of the Industrial Safety and Health Order in Japan)

# 14. Installation Standard Manual

\* Install the unit according the procedure described below (check options and special specifications separately).

Model	Serial number	Date	Person in charge of installation (company name)	Person in charge of installation	Judgment

No.	Item	Method	Reference operation manual	Judgment
<b>Specifications</b>				
1	Accessories	Check the quantities of accessories with the quantities shown in the Accessory column.	<b>10. 10.Specification</b>	
2	Installation	<ul style="list-style-type: none"> <li>Visually check the surrounding area.</li> </ul> Caution: Be careful about surrounding environment, exhauster, applicable oil type, and amount of oil supplied.	<b>2. 2.Before Using This Unit</b> <b>"2. Choose a proper place for installation"</b>	
<b>Operation</b>				
1	Power voltage	<ul style="list-style-type: none"> <li>Using a tester, measure the voltage of the voltage used by the customer (distribution board, outlet, etc.).</li> <li>Measure the voltage during operation (the voltage must be within the standard).</li> </ul> Caution: When a unit is to be connected to the plug or breaker, use one that conforms to the standard.	<b>2. 2.Before Using This Unit</b> <b>"1. Always ground this unit"</b> <b>"7. Choose a correct power distribution board or receptacle"</b>	
			<b>10. 10.Specification</b>	
2	Start of operation	<ul style="list-style-type: none"> <li>Start operation.</li> </ul> BM: Supply water and set the temperature to 50°C, then check the stability. BO: Supply silicon oil and set the temperature to 100°C, then check the stability.	<b>2. 2.Before Using This Unit</b> <b>4. 4.Operation Method</b>	
			<b>5. 5.Handling Precautions</b>	
3	Stop of operation	<ul style="list-style-type: none"> <li>Stop operation.</li> </ul> BO: Notify users that oil temperature is high, and then complete installation.	<b>4. 4.Operation Method</b>	
			<b>5. 5.Handling Precautions</b>	
<b>Description</b>				
1	Description of operation	Explain the operation of each unit to the customer according to this Operation Manual.	<b>1.Cautions in Using with Safety ~ 13. Reference</b>	
2	Error code	Explain error codes and the procedure for resetting them to the customer according to this Operation Manual.	<b>8. 8.In the Event of Failure... ~ 9. After Service and Warranty</b>	
3	Maintenance inspection	Explain the operation of each unit to the customer according to this Operation Manual.	<b>6. 6.Maintenance Method</b>	
4	Completion of installation Information to be entered	<ul style="list-style-type: none"> <li>Enter the date of installation and the name of the person in charge of installation on the face plate on the unit.</li> <li>Enter necessary information on the guarantee, and pass it to the customer.</li> <li>Explain the after-sale service route to the customer.</li> </ul>	<b>9. 9.After Service and Warranty</b>	

## Responsibility

Please follow the instructions in this document when using this unit. Yamato Scientific has no responsibility for the accidents or breakdown of device if it is used with a failure to comply. Never conduct what this document forbids. Unexpected accidents or breakdown may result in.

## Note

- ◆ The contents of this document may be changed in future without notice.
- ◆ Any books with missing pages or disorderly binding may be replaced.

Instruction Manual for

**Water Bath**  
**Model BM500/510**

and

**Oil Bath**  
**Model BO400/410**

Forth Edition    March. 2, 2009

Revised         Feb. 20, 2012

---

**Yamato Scientific Co., Ltd.**

2-1-6 Nihonbashi Honcho, Chuo-ku,  
Tokyo, 103-8432, Japan

<http://www.yamato-net.co.jp>