



- Thermo Elite -

Model

BH401/501

**Precision Low-temperature-controlled Water Bath
with an External Circulation Function**

Instruction Manual

- Fourth Edition -

- Thank you for purchasing "Thermo Elite, BH Series" of Yamato Scientific Co., Ltd.
- To use this unit properly, read this "Instruction Manual" thoroughly before using this unit. Keep this instruction manual around this unit for referring at anytime.
- Consult this Operation Manual and the Operation Manual for the Model CR5 Program Controller for the operation of the product.

⚠WARNING!:

Carefully read and thoroughly understand the important warning items described in this manual before using this unit.

Yamato Scientific Co. LTD.

◆ Cautions in Using with Safety	1
• Explanation.....	1
• Table of Illustrated Symbols	2
• Fundamental Matters of "WARNING!" and "CAUTION!"	3
◆ Before Using This Unit	4
• Requirements for Installation.....	4
• Installation Procedure.....	7
◆ Description and Function of Each Part	12
• Main Unit	12
• Control Panel.....	13
◆ Operation Method	15
• Operation Mode and Function List	15
• Setting of Independent Overheating Prevention Device	17
• Setting the Circulating Pump.....	18
• Temperature Output Terminal.....	19
• RS485 Communication Function.....	21
• Heating Curves (reference data)	34
• Flow Rate and Head (reference data)	35
◆ Handling Precautions	36
◆ Maintenance Method	38
• Daily Inspection and Maintenance	38
◆ Long storage and disposal	39
• When not using this unit for long term / When disposing	39
◆ In the Event of Failure	40
• Safety Device and Error Code.....	40
• Trouble Shooting	41
◆ After Service and Warranty	42
◆ Specification	43
◆ Wiring Diagram	44
• BH401	44
• BH501	45
◆ Replacement Parts Table	46
◆ Reference	47
• List of Dangerous Substances	47
◆ Installation Standard Manual	48

Explanation

MEANING OF ILLUSTRATED SYMBOLS

Illustrated Symbols

Various symbols are used in this safety manual in order to use the unit without danger of injury and damage of the unit. A list of problems caused by ignoring the warnings and improper handling is divided as shown below. Be sure that you understand the warnings and cautions in this manual before operating the unit.

 **WARNING!** If the warning is ignored, there is the danger of a problem that may cause a serious accident or even fatality.

 **CAUTION!** If the caution is ignored, there is the danger of a problem that may cause injury/damage to property or the unit itself.

Meaning of Symbols



This symbol indicates items that urge the warning (including the caution). A detailed warning message is shown adjacent to the symbol.



This symbol indicates items that are strictly prohibited. A detailed message is shown adjacent to the symbol with specific actions not to perform.



This symbol indicates items that should be always performed. A detailed message with instructions is shown adjacent to the symbol.

Cautions in Using with Safety

Table of Illustrated Symbols

Warning



Warning,
generally

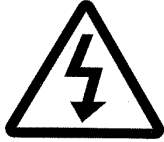

Warning,
high voltage



Warning,
high temperature



Warning,
drive train



Warning,
explosive

Caution



Caution,
generally



Caution,
electrical shock



Caution,
scald



Caution,
no road heating



Caution,
not to drench



Caution,
water only



Caution,
deadly poison

Prohibit



Prohibit,
generally



Prohibit,
inflammable



Prohibit,
to disassemble



Prohibit,
to touch

Compulsion



Compulsion,
generally



Compulsion,
connect to the
grounding
terminal



Compulsion,
install on a flat
surface



Compulsion,
disconnect the
power plug



Compulsion,
periodical
inspection

Cautions in Using with Safety

Fundamental Matters of "WARNING!" and "CAUTION!"

WARNING!

Do not use this unit in an area where there is flammable or explosive gas

Never use this unit in an area where there is flammable or explosive gas. This unit is not explosion-proof. An arc may be generated when the power switch is turned on or off, and fire/explosion may result. (Refer to page 47 "List of Dangerous Substances".)

Always ground this unit

Always ground this unit on the power equipment side in order to avoid electrical shock due to a power surge.

If a problem occurs

If smoke or strange odor should come out of this unit for some reason, turn off the circuit breaker right away, and then disconnect the power plug. Immediately contact a service technician for inspection. If this procedure is not followed, fire or electrical shock may result. Never perform repair work yourself, since it is dangerous and not recommended.

Do not use the power cord if it is bundled or tangled

Do not use the power cord if it is bundled or tangled. If it is used in this manner, it can overheat and fire may be caused.

Do not process, bend, wring, or stretch the power cord forcibly

Do not process, bend, wring, or stretch the power cord forcibly. Fire or electrical shock may result.

Substances that can not be used

Never use explosive substances, flammable substances and substances that include explosive or flammable ingredients in this unit. Explosion or fire may occur. (Refer to page 47 "List of Dangerous Substances".)

Do not disassemble or modify this unit

Do not disassemble or modify this unit. Fire or electrical shock or failure may be caused.

Do not touch high-temperature parts

The inside of the body or the door may become hot during and just after operation. It may cause burns.

CAUTION!

During a thunder storm

During a thunderstorm, turn off the power key immediately, then turn off the circuit breaker and the main power. If this procedure is not followed, fire or electrical shock may be caused.

Requirements for Installation

1. Choose a proper place for installation



- Do not install this unit in a place where:
 - ◆ Rough or dirty surface.
 - ◆ Flammable gas or corrosive gas is generated.
 - ◆ Ambient temperature above 30°C.
 - ◆ Ambient temperature fluctuates violently.
 - ◆ There is direct sunlight.
 - ◆ There is excessive humidity and dust.
 - ◆ There is a constant vibration.
 - ◆ Winds from the air conditioner, etc. hit the sample container directly.



- Install this unit on a stable place with the space as shown below.

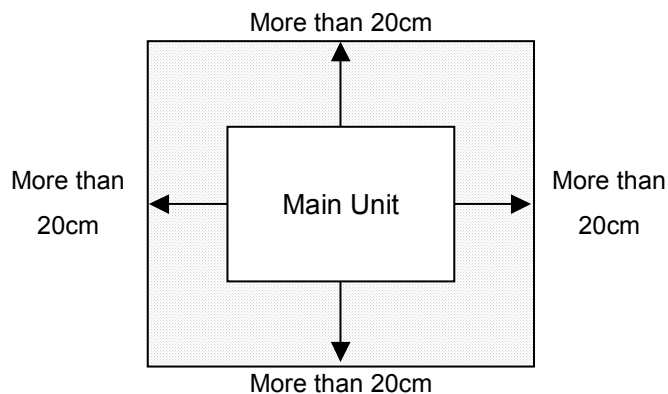

2. Installation on horizontal surface



- Place this unit as flat a place as possible. If the feet are not in uniform contact with the floor surface, noise or vibration may result. Additionally, the unit may cause a problem or malfunction.



- The model BH401 weighs about 20 kg, and the model BH501 weighs about 20 kg.

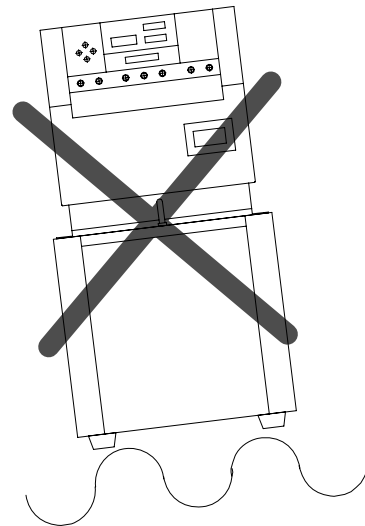

3. Before/after installing



- It may cause injury to a person if this unit falls down or moves by the earthquake and the impact. etc..To prevent, take measures that the unit cannot fall down, and not install to busy place.

Requirements for Installation

4. Keep the unit well-ventilated



- Keep the air intake and the louver in the side and back of the unit open during operation. If they are closed, the inside temperature of the unit may increase, its performance may deteriorate, or an accident, malfunction or fire may result.

5. Do not use the unit in a place where it is exposed to a liquid



- Do not operate the unit in a place where it is exposed to a liquid. If a liquid enters the unit, an accident, malfunction, electric shock or fire may result.

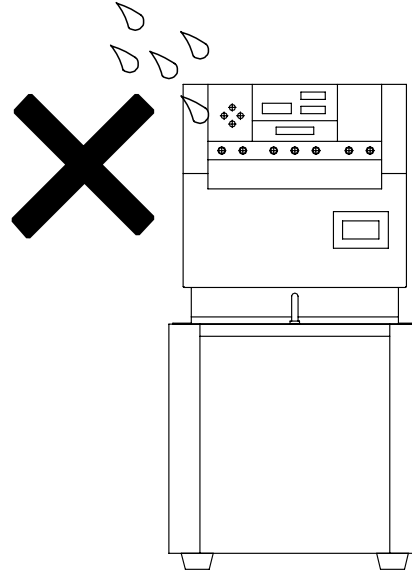

6. Do not use this unit in an area where there is flammable or explosive gas



- Never use this unit in an area where there is flammable or explosive gas. This unit is not explosion-proof. An arc may be generated when the power switch is turned ON or OFF, and fire/explosion may result.



- To know about flammable or explosive gas, refer to page47 “List of Dangerous Substances”.

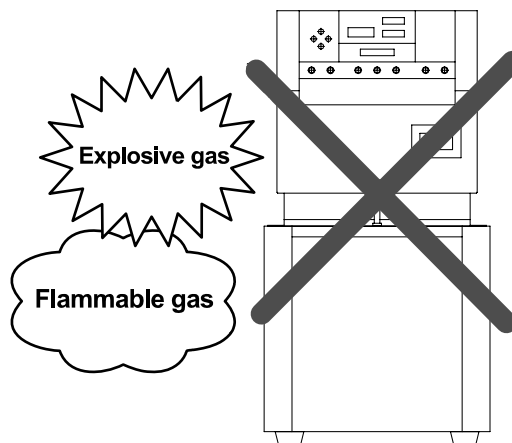

Requirements for Installation

7. Choose a correct power distribution board or receptacle



- Choose a correct power distribution board or receptacle that meets the unit's rated electric capacity.

Electric capacity: BH401: 100V AC, 11A
 BH501: 100V AC, 13A

NOTE)

There could be the case that the unit does not run even after turning ON the power. Inspect whether the voltage of the main power is lowered than the specified value, or whether other device(s) uses the same power line of this unit. If the phenomena might be found, change the power line of this unit to the other power line.

- Starburst connection with a branching receptacle or extended wiring with a cord reel lowers electrical power voltage, which may cause the degradation of refrigeration capability.
- Connect the unit to only the power supply. If it is connected to a gas pipe, water pipe or telephone line, an accident or malfunction may result.

8. Handling of power code



- Do not entangle the power cord. This will cause overheating and possibly a fire.
- Do not bend or twist the power cord, or apply excessive tension to it. This may cause a fire and electrical shock.
- Do not lay the power cord under a desk or chair, and do not allow it to be pinched in order to prevent it from being damaged and to avoid a fire or electrical shock.
- Keep the power cord away from any heating equipment such as a room heater. The cord's insulation may melt and cause a fire or electrical shock.



- If the power cord becomes damaged (wiring exposed, breakage, etc.), immediately turn off the power at the rear of this unit and shut off the main supply power. Then contact your nearest dealer for replacement of the power cord. Leaving it may cause a fire or electrical shock.
- Connect the power plug to the receptacle which is supplied appropriate power and voltage.

9. Always ground this unit





- Be sure to connect the earth wire (the green cable of power cord) to the grounding conductor or ground terminal to prevent accidents caused by electric leakage.

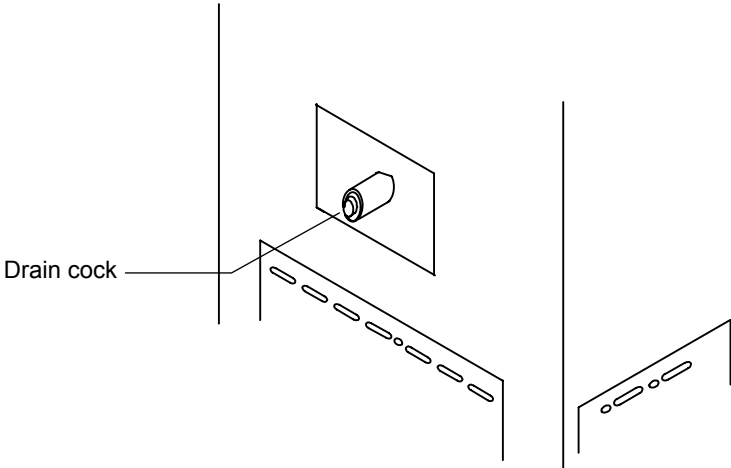
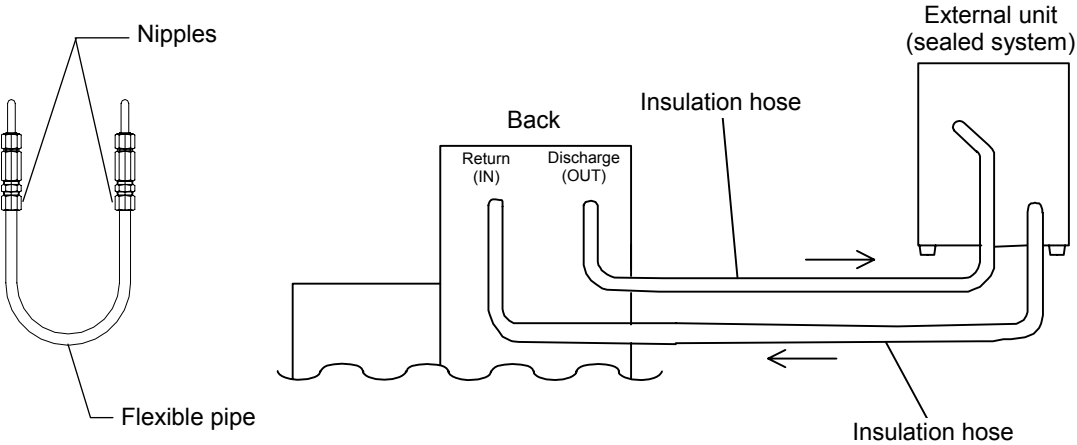

- Do not connect the earth wire to gas or water pipes. If not, fire disaster may be caused.
- Do not connect the earth wire to the ground for telephone wire or lightning conductor. If not, fire disaster or electric shock may be caused.
- Do not use a branching receptacle, which may cause the heat generation.

Installation Procedure

1	<p>Select a flat location for installation. Confirm that the four rubber feet are placed properly.</p>
2	<p>Checking the water discharge port Confirm that the water discharge port in the right side of the equipment is closed with a cap.</p> 
3	<p>For external sealed system connection (The package does not include any circulation hose. Please prepare it separately.) Remove the rear cover and the flexible pipe and nipple for short circuit. Mount the attached hose nipple (hose nipple diameter: 14 mm), and connect the hose to it so that the entire passage will be a sealed system.</p> 
<p> Whenever you use the model BH401 or BH501 with external circulation, use water for the circulating fluid. Do not perform high-temperature external circulation with oil.</p>	

Installation Procedure

4	<p>Precautions about the circulating path</p> <ul style="list-style-type: none">• Carefully check the direction of circulation, and connect the hoses properly. Improper connection results in an accident or malfunction of the unit and the circulating path.• Minimize the length of the circulating path. If resistance inside the piping increases, the quantity of circulating fluid decreases, resulting in lower heating efficiency. For the capacity of the circulating pump, see "Flow Rate and Head (reference data)" on page 35.• Check the circulation capacity and withstand pressure of the circulating path. Excessive circulation or pressure may result in an accident or malfunction.• Do not connect any powered unit or a unit with a motor to the circulating path. It may cause an accident or failure.• If the unit is to be connected to a circulation unit installed in a higher place than it, beware of the backflow of the circulating fluid. If the fluid flows back, it may overflow the water bath of the unit. Add a valve to the circulating path or take other proper measures to prevent a backflow.• The surface of the flexible pipe and nipples for short circuit and the external circulation hose may become cold or hot depending on the set temperature. Exercise care not to get burned or injured.
5	<p>When you use silicon oil for the model BH501, beware of its expansion resulting from heating by the oil. Fill about 80% of the specified quantity of silicon oil.</p>
6	<p>Connecting the power supply Confirm that the leakage breaker is turned "off," and then connect the power plug to the outlet.</p>

Installation Procedure

7 Pour the circulating fluid into the bath.

- Confirm that the drain cock is securely closed, and pour the circulating fluid into the bath.
- Pour the circulating fluid to a level about 3 to 5 cm from the edge of the bath.

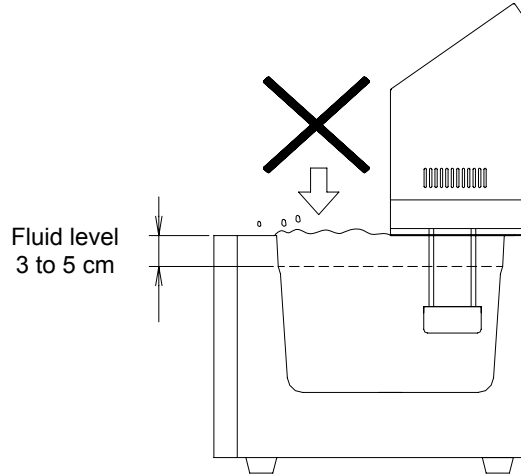

- Confirm that the circulating path is filled with the circulating fluid, and then turn on the leakage breaker and START/STOP key to circulate the fluid.
- In the case of external sealed unit connection, circulate the circulating fluid to the unit's unit to be cooled. After the fluid is stabilized, make up the deficiency.
- After the resupply of the circulating fluid, turn "off" the leakage breaker.
Caution) Slowly pour the circulating oil.



Exercise care not to allow the circulating fluid to get on the unit. If it gets on any electric part, leakage or electric shock may result. If it splashes on the operation panel, wipe it out.

- When you use silicon oil, use a hose (of fluoroelastomer, etc.) that is not susceptible to silicon because the oil swells.
- When you use silicon oil, beware of the expansion of the hose resulting from heating by the oil. Fill about 80% of the specified quantity of silicon oil.
- Use silicon oil with a viscosity of 50 cst.

8 Note for the temperature of the circulating fluid in the bath.

- When the temperature is set higher than 40.1°C, the temperature may be slightly higher than its set because of Agitating Motor heat through the shaft depending on the ambient temperature and the heat radiation through the Unit exterior.

9 When using a throw-in type cooling unit together

- When you use a throw-in type cooling unit, such as a Neo Cool Dip, use the stopper provided on the bottom of the furnace to secure it.

Installation Procedure

10 Handling the controller

- The BH series controller can be remote-operated with the operation panel removed from the unit if an optional "remote operation communication cable" (product code: 281397) and "power supply for remote operation (product code: 281399)" are prepared.
- A "panel stand for remote operation (product code: 281398)" is also available for a removed control panel. It is convenient when the unit is installed in a draft or clean room or controlled from a remote location.

[How to remove the control panel]

1) Unfasten the knurled screws fastening the control panel to the unit (two screws in each of the upper and lower portions).



2) Slowly slide the control panel upward.



3) Carefully disconnect the cable connecting the unit and the control panel from the cable jacks. The cable is bifurcated and connected to two jacks.

*The cable extends only about 10 cm from the unit.



Installation Procedure

[How to mount the control panel]

- 1) Connect the cables extending from the unit to the appropriate jacks in the left side of the control panel. There are three jacks in the control panel: AC power jack, two-pin jack, and three-pin jack from the top.
*The cable extends only about 10 cm from the unit.



- 2) Slowly slide the control panel downward into the control panel space to place.



- 3) Confirm that the control panel is placed on the unit, and then fasten the knurled screws. Confirm that the control panel is firmly secured.



CAUTION!

- The control panel is an optional function. Do not remove it purposelessly.
- The control panel weighs about 1 kg. Exercise care not to drop it.
- Do not place the removed control panel upside down or place anything on it.
- The control panel is a precision unit. Handle it with extreme care.
- Do not miss the unfastened knurled screws.

Description and Function of Each Part

Main Unit

Front view

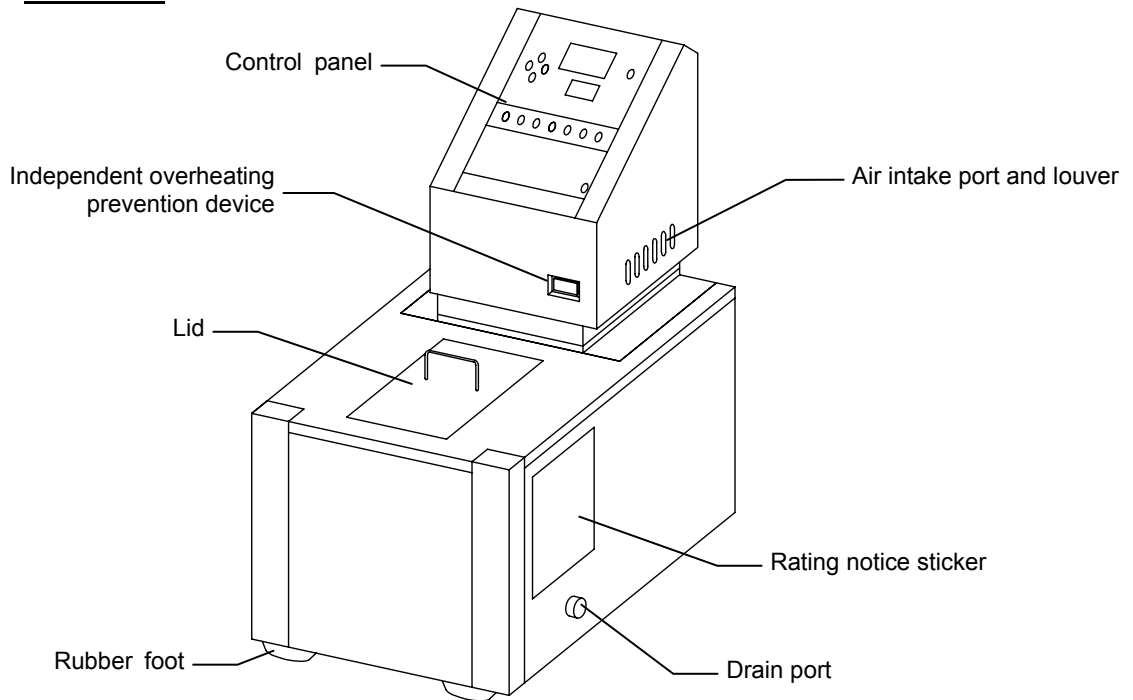

Rear view

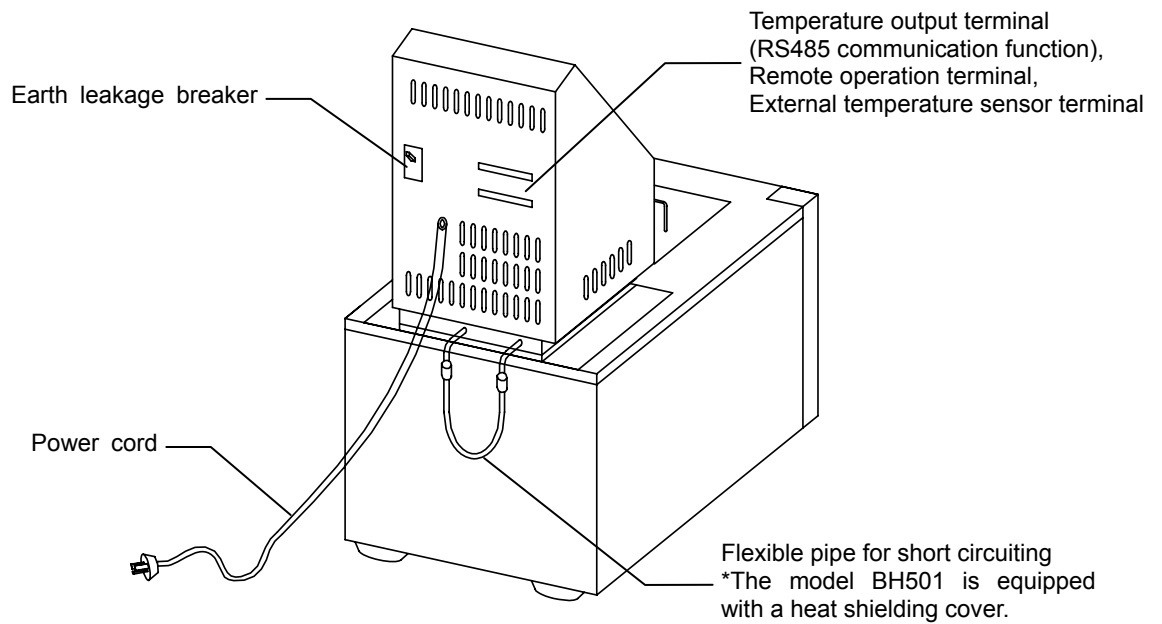

Description and Function of Each Part

Control Panel

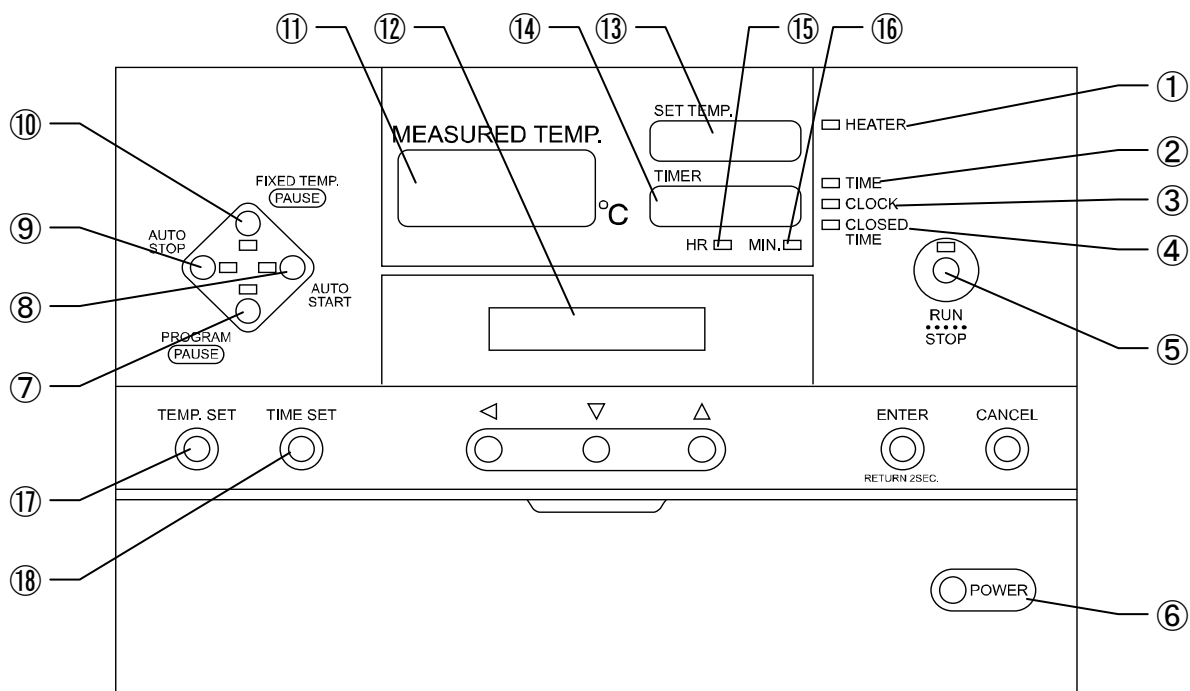

No.	Name	Function
①	HEATER Lamp	Lights when the heater is turned on.
②	TIME Lamp	Lights when the timer is set in hours.
③	CLOCK Lamp	Lights when the timer is set in clock time
④	CLOSED TIME Lamp	Lights when the Timer screen displays the remaining operation time.
⑤	RUN/STOP Key	The key used to activate and deactivate the unit.
⑥	POWER Key	Turns on or off the power to the unit.
⑦	PROGRAM Key	The key used to select program operation.
⑧	AUTO START Key	The selection key used to perform automatic start operation during fixed temperature operation and program operation.
⑨	AUTO STOP Key	The selection key used to select automatic stop operation in fixed temperature operation.
⑩	FIXED TEMP Key	The key used to select fixed temperature operation.
⑪	Measured Temperature Display Screen	Displays the measured inside temperature of the bath, error codes, and other information.
⑫	Operation Guide Screen	Describes the operation or state of the keys currently available.
⑬	Set Temperature Display Screen	Displays set temperature and parameters.
⑭	Timer Display Screen	Displays the set time (or hours), the remaining hours, etc.
⑮	HOUR UNIT Lamp	Lights when the unit for timer setting is hours.
⑯	MINUTE UNIT Lamp	Lights when the unit for timer setting is minutes.
⑰	TEMP SET Key	The key used to set or change the temperature for fixed temperature operation or program operation.
⑱	TIME SET Key	The key used to set or change the hours (time) for fixed temperature operation or program operation.

Description and Function of Each Part

Control Panel

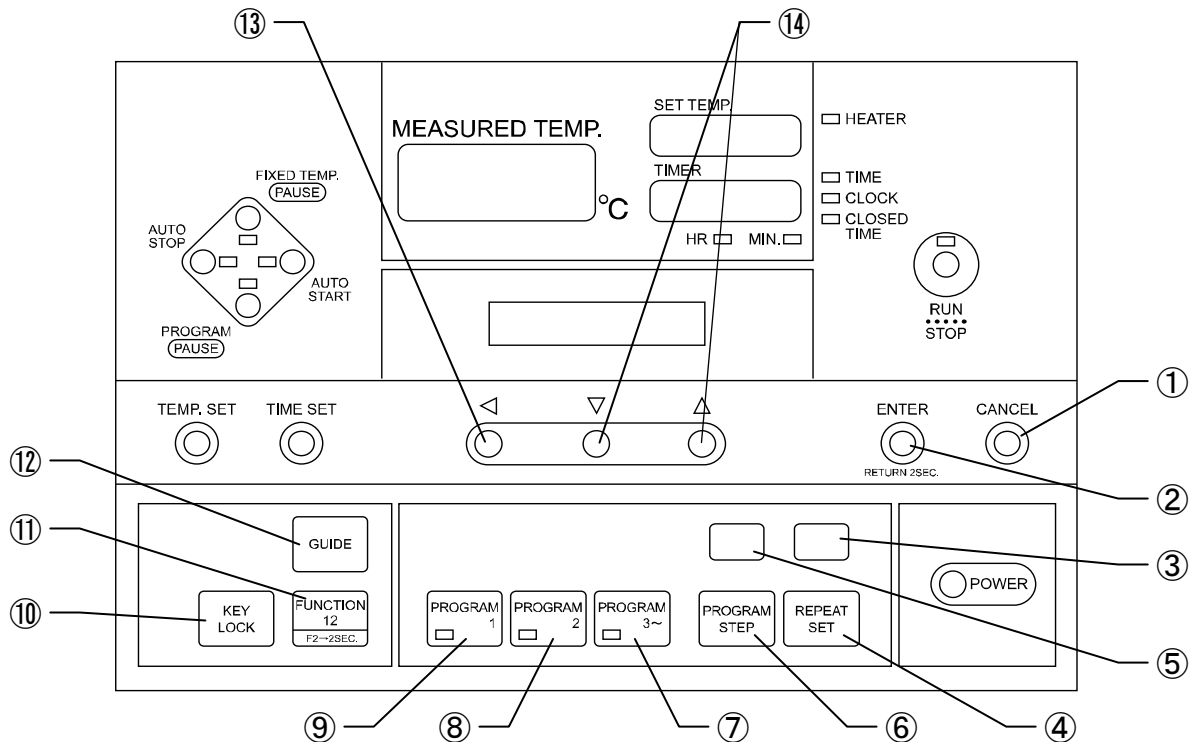

No.	Name	Function
①	CLEAR Key	The key used to cancel an input set value.
②	ENTER Key	The key used to enter (determine) an input set value.
③	Repeat Display Screen	Displays which step number to return for repeat is selected, and the number of repeats.
④	REPEAT SET Key	The key used to set the program repeat function.
⑤	Step Display Screen	Displays selected steps or ongoing step numbers.
⑥	PROGRAM STEP Key	The key used to select and set a program step function.
⑦	PROGRAM 3 - Key	The key used to select program pattern 3 or any subsequent program pattern.
⑧	PROGRAM 2 Key	The key used to select input program pattern 2.
⑨	PROGRAM 1 Key	The key used to select input program pattern 1.
⑩	KEY LOCK Key	The key used to lock key operation or a program pattern.
⑪	FUNCTION 1/2 Key	The key used to set the various functions of the controller.
⑫	GUIDE Key	The key used to show guidance to the operation manual when you want to know how to make settings or operate the monitor, or guidance to the reference page describing the screen currently displayed.
⑬	◀ Key	The key used to shift the digits of set values.
⑭	▼▲ Key	The keys used to decrease/increase set values.

Operation Mode and Function List

There are six operation modes for operation functions as shown below.

For further information, see the attached "Operation Manual for the Model CR5 Program Controller"

No.	Name	Description
1	Fixed temperature operation	Used to perform continuous operation at a fixed temperature.
2	Fixed temperature auto stop operation	Automatically stops operation at a set hours (time).
3	Fixed temperature quick auto stop operation	The mode used to set the automatic stop timer during fixed temperature operation.
4	Fixed temperature auto start operation	Starts operation at a set hours (time).
5	Program operation	Executes program operation.
6	Program auto start operation	Program operation begins at the set time.

The function menu includes the following 15 functions

(including those available when options are equipped).

For further information, see the attached "Operation Manual for the Model CR5 Program Controller"

No.	Name	Description
Functions 1		
1	Calendar/Time setting	You can set the date and the current time.
2	Time/Hour selection	You can select whether to set auto stop operation and auto start operation in hours or in clock time.
3	Buzzer setting	You can turn on or off each of the key operation, time-up, operation disabled, and door open warning sounds.
4	Heater output operation level display	Enables you to monitor the heater output operation level in % at all times.
5	Electric power charge setting display	Enables you to set electric power charges and monitor electric power volumes, electric power charges, and total electric power charges for an hour to a year, the electric power volume per cycle operation, and each electric power charge.
Functions 2		
6	Motor output setting	The function used to set the pump power level in operation.
7	Temperature sensor switching	The function used to set whether to use the sensor on the unit or an external sensor when an external circulation unit is used.
8	Calibration offset setting	The calibration offset temperature compensation function.
9	External communication function setting	The function used to set conditions for external communication.
10	Power failure compensation function setting	The function used to select the start or discontinuance of operation after recovery from a power failure.
11	Indication setting during the driving	An operation guidance screen display can be changed during operation. 1: Usually, a display, 2:calendar display, 3:electric energy display, 4:power-rates display, 5 : it can choose out of five kinds of the amount displays of heater operations.
12	Accumulated time monitor	Enables you to monitor the accumulated operation time of the controller (unit).
13	Warning history monitor	Enables you to monitor information about 20 past errors, including the dates and times they occurred.

Operation Mode and Function List

For operation, see the attached "Operation Manual for the Model CR5 Program Controller"

No.	Operation	Corresponding page of Operation Manual for Model CR5 Program Controller
1	Description of the control panel	P.1
2	Remote control connection of the control panel	P.4
3	Fixed temperature operation	P.10
4	Fixed temperature auto stop operation	P.11
5	Fixed temperature quick auto stop operation	P.12
6	Fixed temperature auto start operation	P.13
7	Program operation	P.14
8	Program auto start operation	P.34
9	Program step change function	P.35
10	Key lock settings	P.40
11	Guide function	P.42
12	Suspension function	P.43
13	Program pattern selection function	P.28
14	Program pattern assignment function	P.25
15	Setting of the functions 1	P.44
16	Setting of the functions 2	P.50

Setting of Independent Overheating Prevention Device

The independent overheating prevention device comprises a temperature measuring circuit, a CPU, a sensor, and an output circuit independently of the controller. If this device becomes activated, the unit comes to a stop and does not recover until the leakage breaker is turned on again (manual recovery).

Setting method

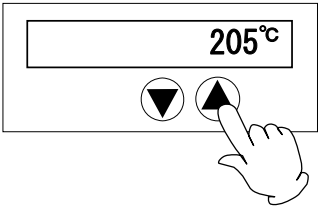
	<ul style="list-style-type: none"> Using the ▼▲ keys, set a temperature.
---	---

Notes

	<ul style="list-style-type: none"> If the difference between the set temperature of the independent overheating prevention device and that of the controller is small, the device may become activated, and the unit may stop operation. Set the temperature of the device at least 5°C higher than the set temperature of the controller. The device cannot be used to protect samples. The temperature was set at BH401:105°C / BH501:205°C before delivery from the plant. To operate the independent overheating prevention device at a desired temperature, operate the inside of the bath at the desired temperature until it is stabilized, gradually reduce the temperature of the device, and confirm that it properly operates at the desired temperature before using it. The device takes about five seconds to start to operate. Wait five seconds, and confirm it. As soon as it starts to operate, Er07 is displayed, and the device stops operation. The working temperature of the temperature sensor of the device depends on the overshoot during temperature rise and the state of samples. Set as high a temperature as possible. After the set temperature of the independent overheating prevention device is changed, it takes several seconds to record the new temperature. Before turning off the power, wait about five seconds.
---	--

Setting the Circulating Pump

The BH series is equipped with a function for changing the flow rate of the circulating pump. For the procedure for changing the flow rate, see the section of "Setting motor output" in the attached "Operation Manual for the Model CR5 Program Controller"

The flow rate can be set at ten different levels from level 1 to level 10, and the circulating pump can be turned off. The discharge pressure is maximum (head) (maximum flow rate) at level 10 or minimum (head) (minimum flow rate) at level 1, and circulation stops by turning off the pump. This function is helpful in adjusting ripples inside the bath or the flow rate for external circulation.

(*If the circulation pump power is changed, its performance may vary as a result of the change in the stirring capability in response to the circulation volume and flow velocity.)

Quick reference of discharge pressures and flow rates at discharge port:

Reference value (error between units: approx. ±30%)

Power frequency Set power	50Hz		60Hz	
	Discharge pressure	Flow rate at discharge port*	Discharge pressure	Flow rate at discharge port*
OFF	Stop	Stop	Stop	Stop
Lv1	0.010 Mpa	4.0ℓ /min	0.016 Mpa	7.0ℓ /min
Lv2	0.012 Mpa	6.0ℓ /min	0.018 Mpa	8.0ℓ /min
Lv3	0.014 Mpa	6.5ℓ /min	0.020 Mpa	9.0ℓ /min
Lv4	0.016 Mpa	7.5ℓ /min	0.022 Mpa	10.0ℓ /min
Lv5	0.018 Mpa	8.5ℓ /min	0.024 Mpa	11.5ℓ /min
Lv6	0.020 Mpa	9.5ℓ /min	0.026 Mpa	12.0ℓ /min
Lv7	0.022 Mpa	11.0ℓ /min	0.028 Mpa	13.0ℓ /min
Lv8	0.024 Mpa	12.5ℓ /min	0.030 Mpa	14.5ℓ /min
Lv9	0.026 Mpa	14.5ℓ /min	0.032 Mpa	16.0ℓ /min
Lv10	0.028 Mpa	15.5ℓ /min	0.034 Mpa	17.0ℓ /min

As shown in the above matrix, the discharge pressure varies by 0.02 MPa (head: 0.2 m) as the set power is raised by a level.

* The flow rate at the discharge port is the value when it is open at a pressure loss of 0.006 MPa.

* The data was obtained when 20°C tap water was used for the circulating fluid.

* See "Flow Rate and Head (reference data)" on page 35.

Temperature Output Terminal

Precautions



- Operate this product according to the procedure described in this Operation Manual. Failure to follow the operation procedure described herein may result in a problem. The guarantee will not apply if you operate the product in the wrong manner.



CAUTION!



- Turn off the breaker before connecting the cables.
- Use alarm output and time-up output at a level equal to or lower than the rated capacity.
- Connect a recorder or another appliance of 600 W or less in input impedance to the temperature output terminal.
- Securely fasten all connections with the screws attached to the terminal block.

Connection procedure



- Connect the cables to the appropriate terminals.
- Alarm output and time-up output are "on" (relay contact closed) during output.
- When using temperature output, use a shielded wire for the cable to be connected to prevent noise.

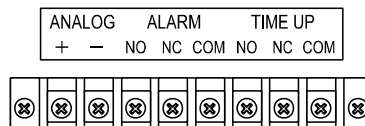

Connection terminal

Temperature Output Terminal

Specification

Temperature Output (ANALOG)	<ul style="list-style-type: none"> The voltage (DC) corresponding to the measured temperature is output. Output temperature range: BH401 0 to 105°C, BH501 0 to 205°C Output voltage: 1 to 5V DC Resolution: 0.1°C Connection: M4 screw terminal block
Alarm Output (ALARM)	<ul style="list-style-type: none"> Output when an error is detected (for details of errors, refer to P.40 "Safety Device and Error Code".) a-contact (relay contact) Contact capacity: 250V AC, 3A (resistance load), 30V DC, 3A (resistance load) Connection: M4 screw terminal block
Time-up Output (TIME UP)	<ul style="list-style-type: none"> Output when the auto stop, auto start or quick auto stop time is up or when the program is ended. a-contact (relay contact) Contact capacity: 250V AC, 3A (resistance load), 30V DC, 3A (resistance load) Connection: M4 screw terminal block

BH401

Temperature (°C)	Output voltage (V)
0	1.00
10	1.38
20	1.76
30	2.14
40	2.52
50	2.90
60	3.29
70	3.67
80	4.05
90	4.43
100	4.81
105	5.00

BH501

Temperature (°C)	Output voltage (V)
0	1.00
10	1.20
20	1.39
30	1.59
40	1.78
50	1.98
60	2.17
70	2.37
80	2.56
90	2.76
100	2.95
110	3.15
120	3.34
130	3.54
140	3.73
150	3.93
160	4.12
170	4.32
180	4.51
190	4.71
200	4.90
205	5.0

RS485 Communication Function

1. Settings Relating to Communication

1.1 Communication Settings

Before starting communication with the CR5 controller (hereinafter called the "unit"), set communication parameters on the personal computer.

	Item	Communication setting
1	Data length	8 bits
2	Stop bit length	2 bits
3	Parity	Disabled
4	BCC check	Enabled
5	Baud rate	4800BPS
6	Response delay time	0msec

1.2 Communication Connections

- Personal computer
 - Use channel 1 (COM1/COM2 port) of the RS232C interface.
- RS232C/RS485 converter
 - For the converter, System Sacom's KS-485 is recommended.
 - Our optional accessory "external communication adapter (RS485-232C) ODK18" permits the connections described in Note 1) below (except the personal computer). A sample program is uploaded on our website.
<http://www.yamato-net.co.jp/support/program/index.htm>
- Communication cable for connection

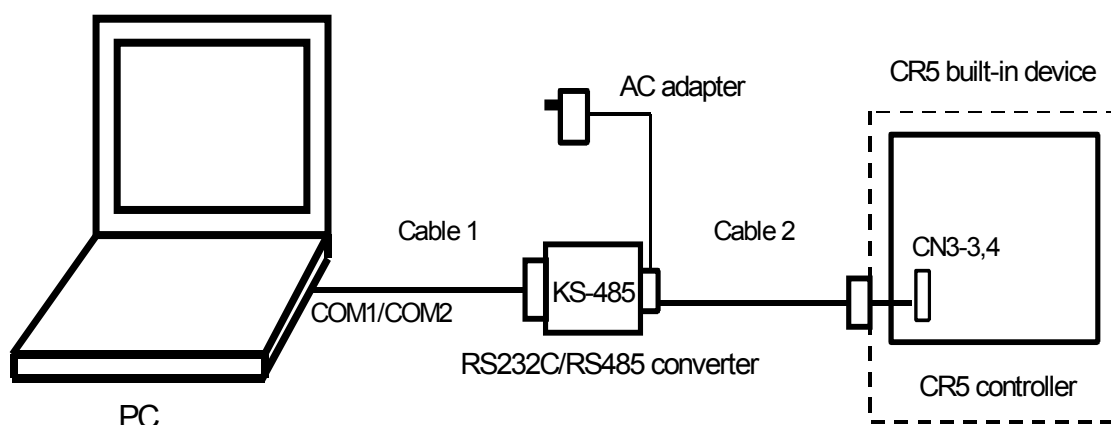

Note)

The optional accessory "external communication adapter (RS485-232C) ODK18" comprises the following:

- ① Communication cable 1: One-meter-long RS-232C cable with a connector (for IBM nine-pin appliance connection) to the personal computer and System Sacom's CBL16 connector (Dsub 25-pin male) to the KS-485
- ② Communication cable 2: Three-meter-long UL2464TASB two-core AWG20 cable with a connector (Dsub nine-pin male) to the KDS-485 and a Y-terminal (with a 100W terminating resistor) to the unit
- ③ RS-232C <=> KS-485 conversion unit: System Sacom's KS-485 with an AC adapter

RS485 Communication Function

2. Data Transmission Method

Item	Specification
Communication standard	EIA standard, complying with RS-485
Synchronization method	Asynchronous communication method
Communication method	Half-duplex communication
Transmission code	ASCII code
Baud rate	1200/2400/4800/9600BPS
Communication distance	Max. 500 m (It depends on the effect of the ambient environment.)
Network	Multi-drop method (up 1:31 stations)
Signal wire	Two wires for transmission and receipt
Stop bit length	1/2bits
Data length	7/8bits
Parity	None/Odd/Even
BCC check	Enabled/Disabled
Response delay time	0 to 250msec
Communication address	1 to 99 stations (however, 1:31 stations at maximum)
Communication mode switching	RO/RW

Note) The shading indicates the initial setting of the unit.

3. Transmission Control Characters

Symbol	Name	Code	Detail
STX	Start of text	02H	Indicates the start of the text.
ETX	End of text	03H	Indicates the end of the text.
R	Read	52H	The command to read a request.
W	Write	57H	The command to write a request.
ACK	Acknowledge Character	06H	Transmits a reply when data is properly received.
NAK	Negative Acknowledge	15H	Transmits a replay in case of a receiving error.

Note)

R: Read (command to read settings or measured values)

W: Write (command to write set values)

R commands can be communicated at all times in all modes.

W commands can be communicated in regular mode only, and the parameters that can be set depend on the operation state (during operation). See "7. List of Identifiers/Commands"

4. Transmission Control Procedures

4.1 Communication Procedure

- This unit returns a "reply message" to a "request message" from the host computer but does not start transmission.
- This unit does not start communication (no reply) for about four seconds after the power is turned on. Set a delay until communication begins after the power is turned on.

RS485 Communication Function

4.2 Message Types

- Message types include transmission request messages from the host computer and transmission reply messages from this unit.
- All codes from STY, address, request, identifier to ETX (except BCC) are represented by ASCII codes.

4.3 Request Message Structures (transmission from the host computer to the unit)

4.3.1 Structure of Read Request Messages

①	Start code
②	Address
③	Request (read)
④	Identifier
⑤	-
⑥	End code
⑦	BCC data

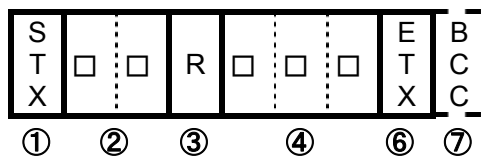

4.3.2 Structure of Write Request Messages

①	Start code
②	Address
③	Request (write)
④	Identifier
⑤	Numeric data
⑥	End code
⑦	BCC data

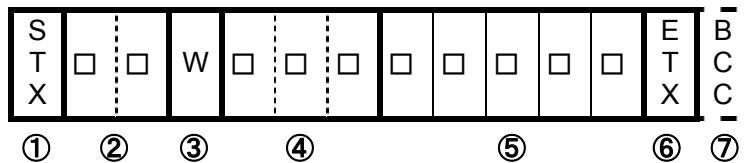

4.3.3 Structure of Storage Request Messages

①	Start code
②	Address
③	Request (write)
④	Identifier
⑤	-
⑥	End code
⑦	BCC data

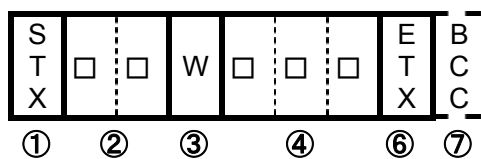

RS485 Communication Function

4.4 Reply Message Structures

4.4.1 Reply Messages to Read Request Messages

①	Start code
②	Address
④	Identifier
⑤	Numeric data
⑥	End code
⑦	BCC data
⑧	Acknowledgement code

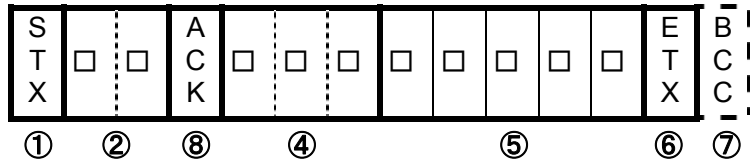

4.4.2 Reply Messages to Write Request/Storage Request Messages

①	Start code
②	Address
⑥	End code
⑦	BCC data
⑧	Acknowledgement code

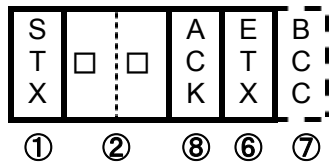

4.4.3 Reply Messages In Case of an Error

①	Start code
②	Address
⑥	End code
⑦	BCC data
⑨	Negative acknowledgement code
⑩	ERR type

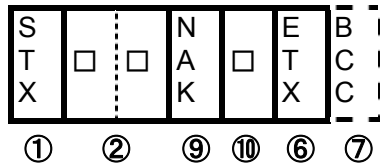

RS485 Communication Function

4.5 Description of Codes

- The following codes from ①STX, ②address to ⑩error type are represented by ASCII codes.
- For ASCII codes, see "8. List of ASCII Codes"
- For conversion into ASCII codes, see "5. Communication Examples"

① STX

This code is required for the receiving side to detect the head of a message. Add it at the head of the character string to be transmitted.

② Address

This is the address of the unit with which the host computer communicates. The address within a reply message from the unit indicates the unit that has transmitted the message.

③ Request

Enter the symbol "R" or "W."

R: To read data from the unit

W: To write data to the unit or save it in the unit

④ Identifier

This is the classification symbol (identifier) of the data to be read or written and represented by a three-digit alphanumeric ASCII code. See "7. List of Identifiers/Commands"

⑤ Numeric data

This is the data to be read or written and always represented by five digits, irrespective of the type. Negative data: The symbol "-" is at the highest digit.

Position of decimal point: Five-digit data does not include any decimal point.

Example) The meaning of the five-digit numeric data **00101** is shown in the table below.

Example		Meaning of numeric data
Set temperature (SV1)	When the temperature sensor is a thermocouple	→ 101°C
	When the temperature sensor is platinum	→ 10.1°C
Set time (TIM)		→ One hour and one minute

⑥ ETX

This code is required for the receiving side to detect the end of the message. Add it at the end of the character string to be transmitted (except BCC).

⑦ BCC

This is the check code for error detection and takes the exclusive OR (EX-OR) of all characters from STX to ETX. When "Enabled" is selected for BCC check among the communication settings for the unit, this code (BCC) will not be included in the reply message.

⑧ ACK

This is an acknowledgement code and included and returned in the "reply message" from the unit when no error is found in the received message.

RS485 Communication Function

⑨ **NAK**

This is a negative acknowledgement code and included and returned in the "reply message" from the unit when there is an error in the "request message" received by the unit.

⑩ **ERR type**

If there is an error in the "request message" received by the unit, this code is included in the "reply message" from the unit after "(9) NAK" to report the type of the error.

This is a communication-related error, and details of display are omitted.

If STX is not transmitted from the unit within the specified reply wait time after the host computer receives BCC, it is considered receive time-out.

RS485 Communication Function

5. Communication Examples

5.1 Read communication example

Example) Request message:

A request for reading PV is transmitted to the unit set at address 02.

Reply message from the unit to this request message: The data of PV (00123) is returned.

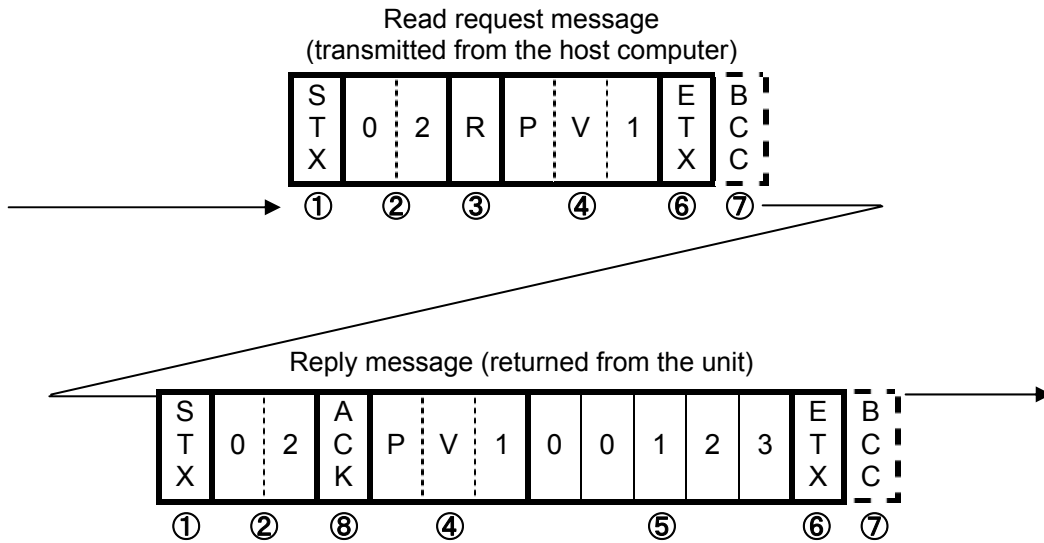

Code	Symbol/Data	ASCII code ^{*2}
① Start Code	STX	02H
② Address	02	30H 32H
③ Request (Read)	R	52H
④ Identifier ^{*1}	PV1	50H 56H 31H
⑤ Numeric Data	00123	30H 30H 31H 32H 33H
⑥ End Code	ETX	03H
⑦ BCC data	Request	61H
	Reply	02H
⑧ Acknowledgement code	ACK	06H

*1): See "7. List of Identifiers/Commands"

*2): For ASCII codes, see "8. List of ASCII Codes"

RS485 Communication Function

5.2 Write communication example

Example) Request message:

A request for setting "SV to 135" (writing 135) is transmitted to the unit set at address 03.

Reply message from the unit to this request message: Information that the request message has been received is returned.

- Confirm that the data has been properly written by reading it separately.

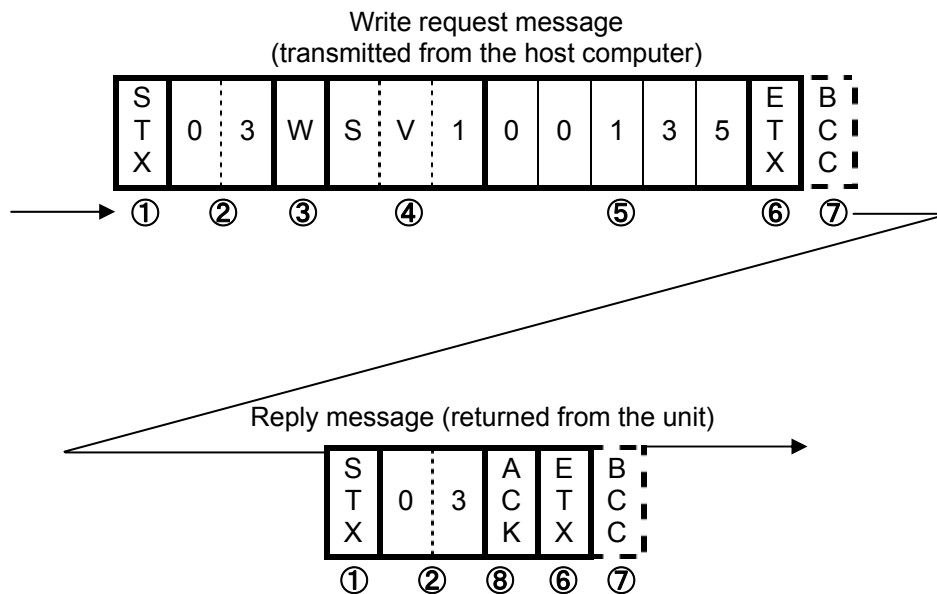

Code	Symbol/Data	ASCII code *2
① Start Code	STX	02H
② Address	03	30H 33H
③ Request (Write)	W	57H
④ Identifier *1	PV1	53H 56H 31H
⑤ Numeric Data	00135	30H 30H 31H 33H 35H
⑥ End Code	ETX	03H
⑦ BCC data	Request	56H
	Reply	04H
⑧ Acknowledgement code	ACK	06H

*1): See "7. List of Identifiers/Commands"

*2): For ASCII codes, see "8. List of ASCII Codes"

RS485 Communication Function

6. Wire Connection

Shown below is an example of multi-drop wire connection.

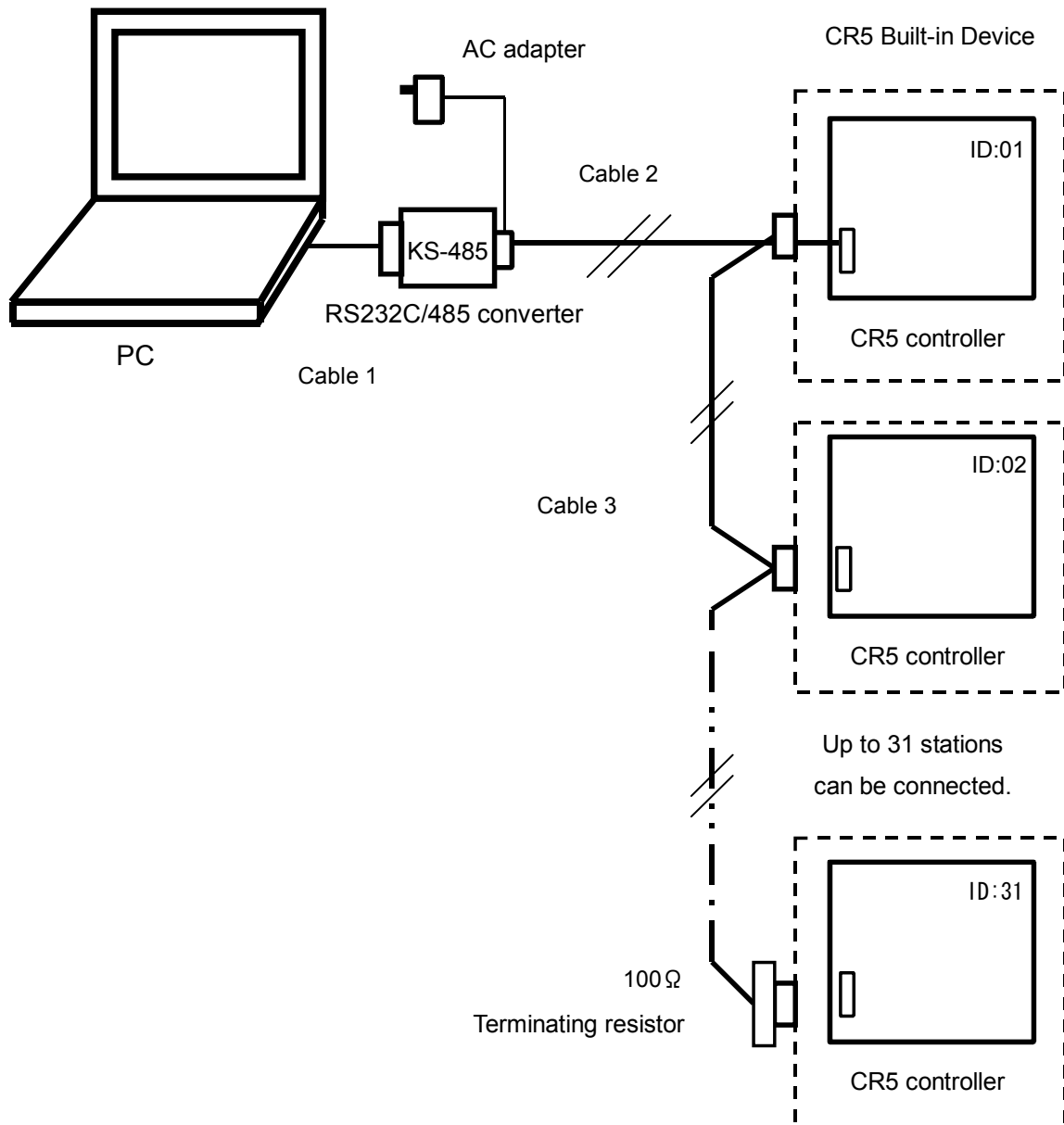

Note 1) Communication cable 1: One-meter-long RS-232C cable with a connector (for IBM nine-pin appliance connection) to the personal computer and System Sacom's CBL16 connector (Dsub 25-pin male) to the KS-485

Note 2) Communication cables 2 and 3: Custom-made items.

Note 3) Terminating resistor: Custom-made item. If you prepare a terminating resistor yourself, connect a fixed resistor of 100 Ω and 1/4 W or over to the last cable appliance terminal block.

RS485 Communication Function

7. List of Identifiers/Commands

<Identifiers and set values>

*1: Set values equal to or more than 100 hours in the unit of the hour.

*2: " _ " means a space.

*3: A parameter with which a W command is valid during each operation (valid during operation in regular mode).

Fixed-temperature operation parameters

Name	Identifier	Command	Set value
Temperature setting	SV1	R/W/**	SLL~SLH : Set value limiter lower limit - set value limiter upper limit °C (*3)
Event output setting	EVE	R/W/**	00000 : Event output OFF 00001~00015 : Pattern 1 to pattern 15
Motor output setting	FAN	R/W/**	When ON/OFF control is selected for the motor output selection setting, 00000 : Without motor control 00001 : With motor control When level control is selected, 00000 : Without motor control 00001 - 00010 : Level 1 to level 10
Refrigerator output setting	LEI	R/W/**	00000 : Without refrigerator control 00001 : With refrigerator control (regular operation) 00002 : With refrigerator control (forced operation)

Program operation parameters

Name	Identifier	Command	Set value
Temperature setting	S01~S99	R/W/**	SLL~SLH : Set value limiter upper limit - set value limiter lower limit °C (*1, *3)
Time setting	T01~T99	R/W/**	00000 - 09959 : 0 hours and 0 minutes to 99 hours and 59 minutes H0000 - H9999 : 100 hours to 9999 hours
Repeat destination setting	R01~R99	R/W/**	00001 - 00099 : Step 1 to step 99
Repeat number setting	C01~C99	R/W/**	00000 : None 00001~00099 : Once to 99 times 00100 : Unlimited
End operation setting	O01~O99	R/W/**	00000 : End state 00001 : Hold state 00100 : Fixed-value state
Pattern number setting	PSN	R/W/**	00001~00099 : Program 1 to program 99
Step number setting	STC	R/W/**	00000 : Without steps (steps unregistered) 00001~00099 : Step 1 to step 99
Program number selection	PSP	R/W/**	00000 : Program1 00001 : Program2 00100 : Program3

RS485 Communication Function

Program operation parameters

Name	Identifier	Command	Set value
Step number selection	STN	R/W/**	00001~00099 : Step 1 to step 99
Motor output	F01~F99	R/W/**	When ON/OFF control is selected for the motor output selection setting, 00000 : Without motor control 00001 : With motor control When level control is selected, 00000 : Without motor control 00001~00010 : Level 1 to level 10

Auto start operation parameters

Name	Identifier	Command	Set value
Auto start time setting	SST	R/W/**	When hour control is selected, 00000~09959 : 0 hours and 0 minutes to 99 hours and 59 minutes (*1) H0100~H9999 : 100 hours to 9999 hours When clock time control is selected, 00000~02359 : 0 hours and 0 minutes to 23 hours and 59 minutes

Auto stop operation parameters

Name	Identifier	Command	Set value
Auto stop time setting	SPT	R/W/**	When hour control is selected, 00000~09959 : 0 hours and 0 minutes to 99 hours and 59 minutes (*1) H0100~H9999 : 100 hours to 9999 hours When clock time control is selected, 00000~02359 : 0 hours and 0 minutes to 23 hours and 59 minutes

Other parameters

Name	Identifier	Command	Set value
Year setting	YAR	R/W/**	00000~00099 : 0 to 99
Month setting of date	MON	R/W/**	00001~00012 : January to December
Day setting of date	DAY	R/W/**	00000~00031 : 1st to 31st
Hour setting of time	HOU	R/W/**	00001~00012 : 0 to 23 hours
Minute setting of time	MIN	R/W/**	00001~00012 : 0 to 59 minutes
Power ON/OFF	POW	R/W/**	00000 : Power OFF (*3) 00001 : Power ON
Operation start/stop	RUN	R/W/**	00000 : Stop (*3) 00001 : Start
Operation type selection	OKS	R/W/**	00000 : Fixed-value operation selected 00001 : Program operation selected

RS485 Communication Function

Other parameters

Name	Identifier	Command	Set value
Timer operation selection	TOS	R/W/**	00000 : Without timer operation 00001 : Auto start operation 00002 : Auto stop operation
Remaining time monitor	_TI	R/**/**	00000 : Timer up or operation stop (*2) 00001~09959 : 0 hours and a minute to 99 hours and 59 minutes H0100~H9999 : 100 hours to 9999 hours
Program number monitor	_MN	R/**/**	00000 : Program 1 selected (*2) 00001 : Program 2 selected H0100 : Program 3 selected
Step number monitor	_ST	R/**/**	00000 : Timer up or operation stop (*2) 00001~00099 : Step 1 to step 99
Key lock	KLC	R/W/**	00000 : Key lock released 00001 : Key lock
Output monitor 1	OM1	R/**/**	00000 : First digit = Heater output Second digit = Refrigerator output Third digit = Main output Fourth digit = Warning output Fifth digit = Buzzer output ※ Output state : 0 = Output OFF, 1 = Output ON
Output monitor 2	OM2	R/**/**	00000 : First digit = Event 1 output Second digit = Event 2 output Third digit = Event 3 output or operation output Fourth digit = Event 4 output or timer-up output Fifth digit = Motor relay output ※ Output state : 0 = Output OFF, 1 = Output ON
Error monitor 1	ER1	R/**/**	00000 : First digit = Sensor error Second digit = Heater short error Third digit = Heater wire disconnection error Fourth digit = Independent overheating prevention error Fifth digit = Refrigerator error ※ Error state : 0 = No error exists, 1 = An error exists
Error monitor 2	ER2	R/**/**	00000 : First digit = Memory error Second digit = AT error Third digit = Internal communication error Fourth digit = Empty unit operation error Fifth digit = Door open ※ Error state : 0 = No error exists, 1 = An error exists
Main measured temperature monitor	PV1	R/**/**	In the case of thermocouple input (Example) 00100: 100°C In the case of platinum input (Example) 01000: 100.0°C
External measured temperature monitor	PV2		In the case of both thermocouple input and platinum input: HHHHH : Measured temperature over-scale LLLLL : Measured temperature under-scale

RS485 Communication Function

8. List of ASCII Codes

ASCII code	02H	03H	06H	15H						
Symbol	STX	ETX	ACK	NAK						

ASCII code	30H	31H	32H	33H	34H	35H	36H	37H	38H	39H
Numeric	0	1	2	3	4	5	6	7	8	9

ASCII code	2DH	20H								
Numeric	— (minus)	SP (space)								

ASCII code	41H	42H	43H	44H	45H	46H	47H	48H	49H	4AH
Symbol	A	B	C	D	E	F	G	H	I	J

ASCII コード	4BH	4CH	4DH	4EH	4FH	50H	51H	52H	53H	54H
Symbol	K	L	M	N	O	P	Q	R	S	T

ASCII コード	55H	56H	57H	58H	59H	5AH	20H			
Symbol	U	V	W	X	Y	Z	SP (space)			

Heating Curves (reference data)

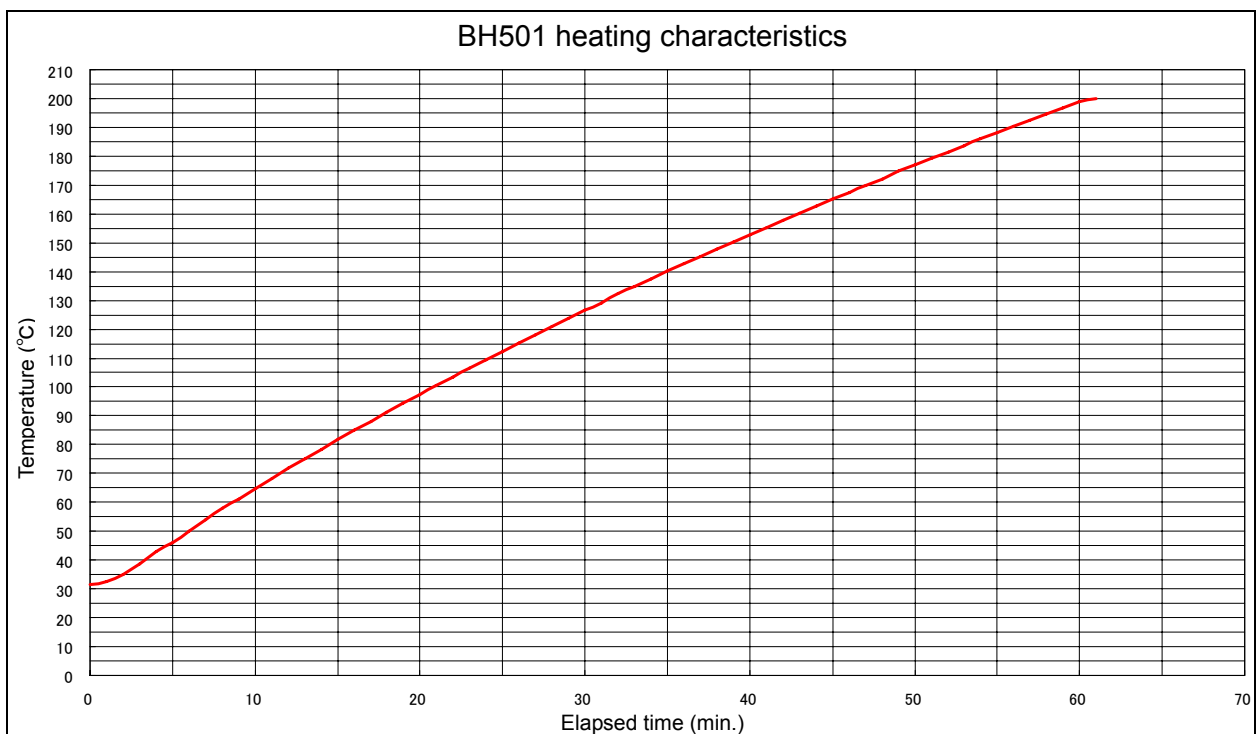
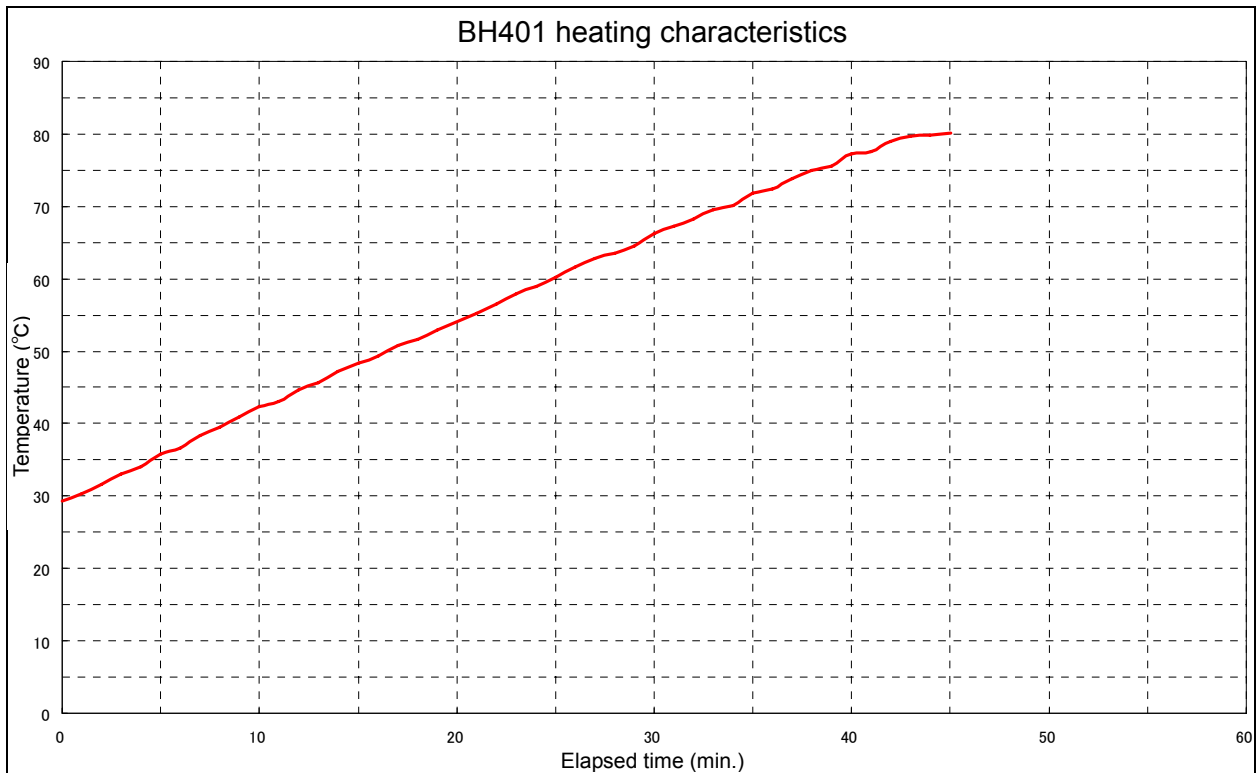

Flow Rate and Head (reference data)

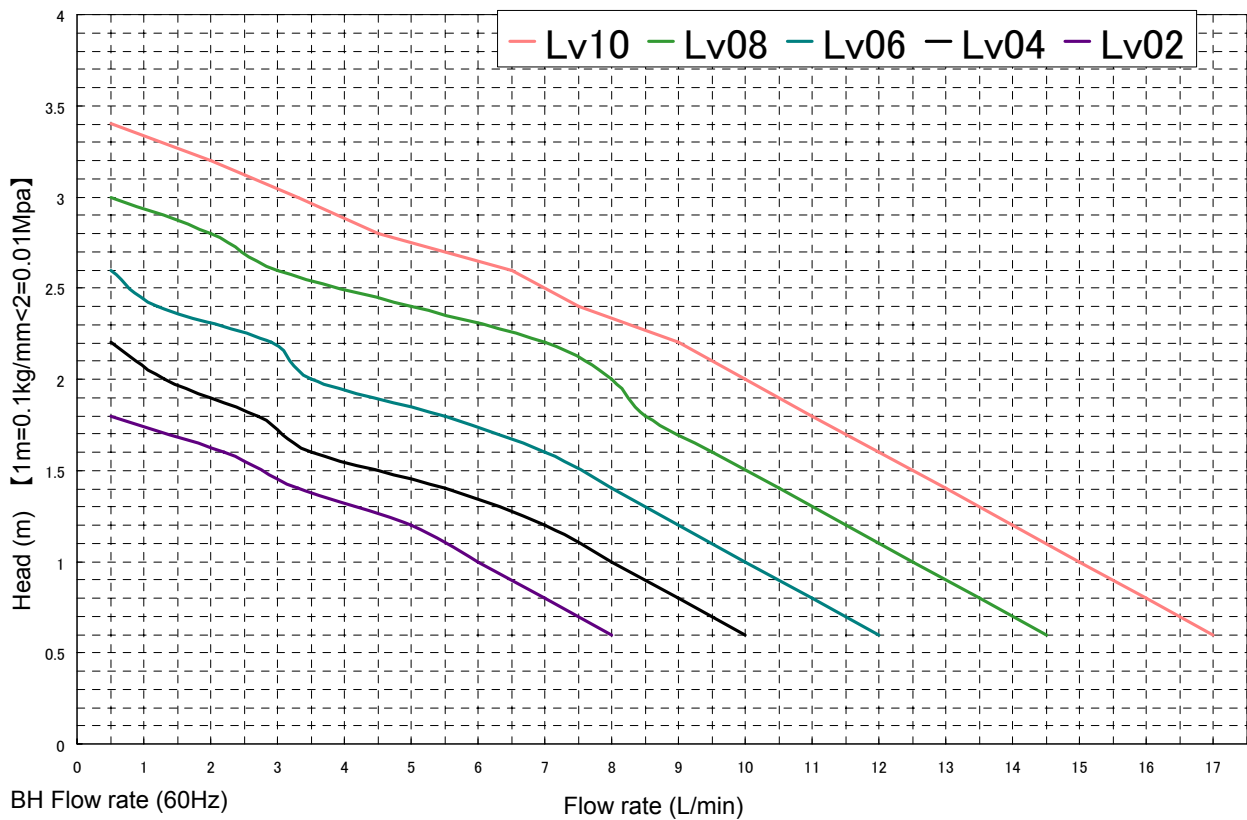
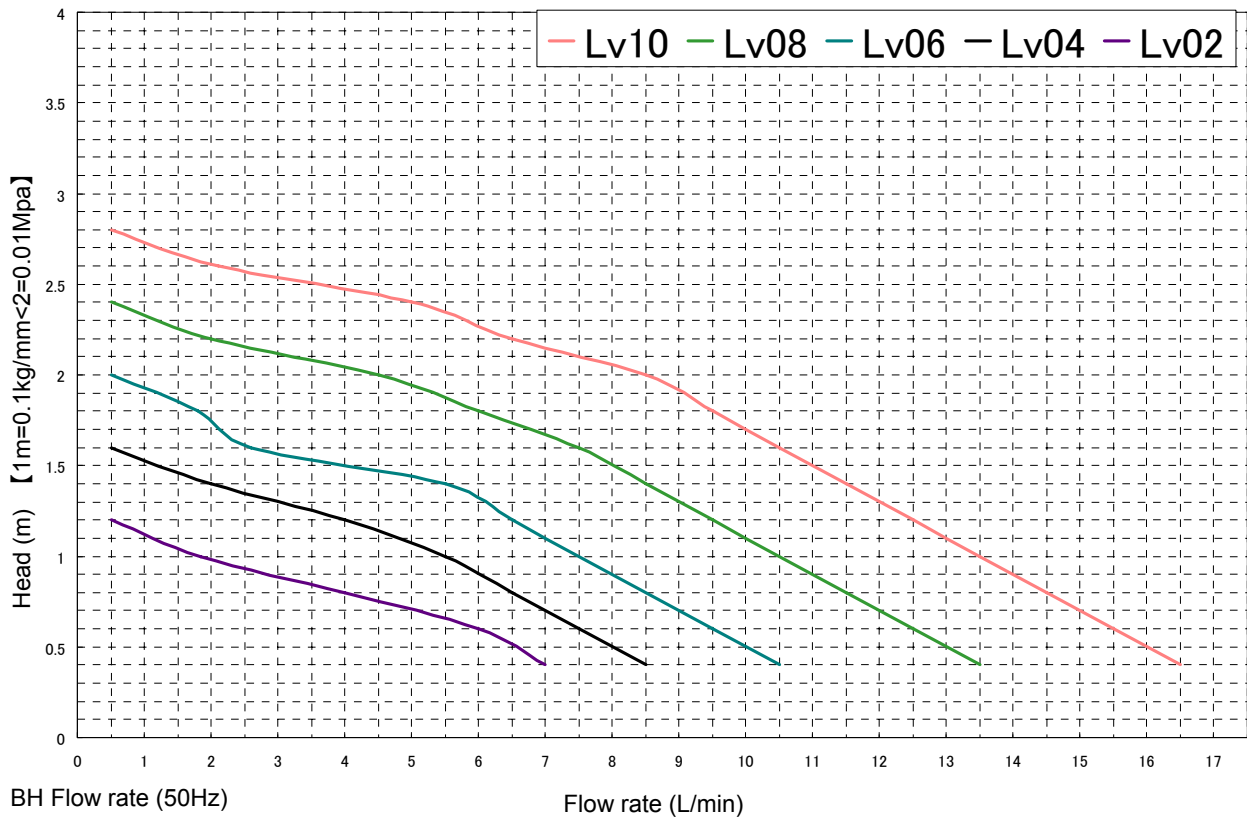

WARNING!

If a problem occurs

-  If smoke or strange odor should come out of this unit for some reason, turn off the power key right away, and then turn off the circuit breaker and the main power. Immediately contact a service technician for inspection. If this procedure is not followed, fire or electrical shock may result. Never perform repair work yourself, since it is dangerous and not recommended.

Measure for flammability and handling of flammable solvent

-  This unit is not designed as the explosion-proof construction. Pay special attention to the handling of the sample to be handled with this unit on the consumption with the explosive material, flammable material, and similar ones. The flammable material may be vaporized by leaving it at the temperature higher than room temperature, and could cause the fire or explosion. When handling such material, provide ventilation with enough before the operation. (Refer to page 47 "List of Dangerous Substances".)

Keep the unit well-ventilated

-  Keep the air intake and the louver in the side and back of the unit open during operation. If they are closed, the inside temperature of the unit may increase, its performance may deteriorate, or an accident, malfunction or fire may result.

Exercise care not to allow a liquid to get on the unit

-  Exercise care not to allow a liquid to get on the unit or enter the unit through the air intake or louver in the side or back of the unit. If it enters the unit, stop the operation. Otherwise, an accident, malfunction, electric shock or fire may result.

Install an exhaust unit

-  When you use silicon oil for the model BH501, use the system in an environment with an exhaust unit installed. Otherwise you may harm your health with oil smoke.

Do not drop metallic pieces into the unit

-  Do not drop metallic pieces, such as clips, staples and screws, into the unit. If such a metallic piece has dropped into the unit, turn it off. An accident, malfunction, electric shock or fire may result.

Do not open the panels and covers

-  Do not operate the unit with the fixed panels and covers open. An accident, malfunction or electric shock may result.

Do not modify

-  Do not modify this unit. An accident, malfunction, electric shock or fire may result.

CAUTION!

Do not step on this unit

 Do not step on this unit. It will cause injury if this unit fall down or break.

Do not place or drop anything on the unit

 Do not place or drop anything on the unit. Since the unit contains precision components, it may malfunction due to vibration, impact, etc.

During a thunder storm

 During a thunderstorm, turn off the power key immediately, then turn off the circuit breaker and the main power. If this procedure is not followed, fire or electrical shock may be caused.

Countermeasure for stop operation during night or long-term stop

 In case of stopping operation during night or long-term, toggle the breaker and power switch to "OFF".

Thoroughly wash the unit.

 The unit was washed already. However, when you first use it or operate it after a long period of deactivation, thoroughly wash it.

Circulating fluid

 Set a circulating fluid according to the working temperature.
Set temperature + 90°C or below: Water
Set temperature + 80°C or over: silicon oil (viscosity 50cst or over)

Recovery from a power failure

 If the unit was deactivated in the middle of operation due to a power failure and is re-energized, the unit automatically returns to the state just before the power failure and resumes operation. To make manual recovery valid, make necessary settings according to "H06 Function 2: Power failure compensation setting" in the "Operation Manual for the Model CR5 Program Controller".
If the resumption of operation by automatic recovery is inconvenient, turn off the leakage breaker.

Abnormal fluid level

 Check the circulating fluid level. Then, resupply it.

Do not open the drain port in the middle of operation

 Do not open the drain port in the middle of operation or operate the unit with the port open. The pump may malfunction.

Do not operate the unit without a fluid

 Do not operate the unit without a fluid. Operating the unit with the heater exposed, the unit may malfunction.

Do not perform what is not described in the Instruction Manual

 Do not perform what is not described in the Instruction Manual. An unexpected accident may occur.

Daily Inspection and Maintenance

Perform daily maintenance inspections to operate the unit safely and in good condition. Much scale accumulates in the unit if tap water is used. Perform maintenance inspection with emphasis placed on it.

WARNING!

- Disconnect the power cable from the power source when doing an inspection or maintenance unless needed.
- Perform the daily inspection and maintenance after returning the temperature of this unit to the normal one.
- Do not disassemble this unit.

CAUTION!

- Use a well-drained soft cloth to wipe dirt on this unit. Do not use benzene, thinner or cleanser for wiping. Do not scrub this unit. Deformation, deterioration or color change may result in.

Monthly maintenance

- Check the earth leakage breaker function.
 1. Connect the power cord.
 2. Turn the breaker on.
 3. Push the red test switch by a ballpoint pen etc.
 4. If there is no problem, the earth leakage breaker will be turned off.

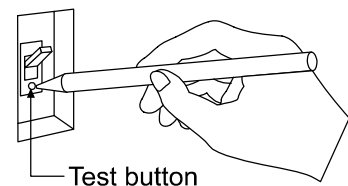

Maintaining the water bath

- Some types of circulating fluid condense and accelerate the accumulation of scale. If the water bath is contaminated by fur or scale, dip out the water or drain it out from the drain cock, and wash the bath clean.
- Use ion-exchanged water or distilled water, and clean the water bath as appropriate. If ground water or tap water is used, fur or scale accumulates inside the bath and not only contaminates it but also deteriorates heater efficiency and service life. Clean it as appropriate.

 **Exercise extreme care not to get injured. It is very dangerous for you to perform operations with bare hands. Wear gloves.**

- ① Disconnect the power cord from the distribution board and the outlet.
- ② Drain the circulating fluid. (to drain, open the cap of drain port) Before draining off the circulating fluid, confirm that it is not hot (+40° C or below).

 **Before draining off the circulating fluid, confirm that it is not hot (+40°C or below). If it is hot, you may get burned.**

When not using this unit for long term / When disposing

CAUTION!

When not using this unit for long term...

- Turn off the breaker and disconnect the power cord.

WARNING!

When disposing of the unit

- Keep out of reach of children.
- Ask a qualified disposal service company for the disposal of it.

Environmental protection should be considered

We request you to disassemble this unit as possible and recycle the reusable parts considering to the environmental protection. The feature components of this unit and materials used are listed below.

Component Name	Material
Exterior Parts	
Outer covering	Bonderizing steel plate baked with melamine resin coating
Inner bath	Stainless steel SUS304
Brace	Aluminum
Plates	PET resin film
Electrical Parts	
Switches, Relay	Resin, copper and other
Circuit boards	Composite of glass fiber and other
Pipe heater	SUS316L
Power cord	Synthetic rubber coated wiring materials, copper and nickel
Pump	Iron, copper, resin and ceramic
Piping Parts	
Pipes	SUS304

Safety Device and Error Code

This unit has an automatic diagnosis function built in the controller and safety devices independent of the controller. The table below shows the cause and the solution method when the safety device operates.

Error Code:

When an abnormal condition occurs, an error code appears in the controller and the buzzer sounds simultaneously. Record the error code and turn off the power of device immediately.

Safety Device	Notify	Cause/Solution
Sensor trouble detection	"Er.01" appears	<ul style="list-style-type: none"> • Failure in temperature input circuit. • Temperature sensor is broken or disconnected. • The measured temperature is out of the display range. • Make a call for service.
SSR short-circuit detection	"Er.02" appears	<ul style="list-style-type: none"> • SSR is in short-circuit • Make a call for service.
Heater disconnecting detection	"Er.03" appears	<ul style="list-style-type: none"> • Heater is disconnected. • Make a call for service.
Overheating prevention device	"Er.07" appears	<ul style="list-style-type: none"> • Overheating prevention device is in operation. • Reset the power supply, and then adjust the setting temperature of the overheating protection device. • If the state does not recover, make a call for service.
Memory error	"Er.15" appears	<ul style="list-style-type: none"> • Failure in internal memory. • Make a call for service.
Internal communication error	"Er.17" appears	<ul style="list-style-type: none"> • Communication error between the control board and the display board. • Make a call for service.
Abnormal fluid level	"StoP" appears	<ul style="list-style-type: none"> • The quantity of the circulating fluid is insufficient. • The float switch is defective. • The fluid is filled over the safe water level (model BH501). • Make a call for service.

Trouble Shooting

Phenomenon	Check point
The unit does not start to operate although the leakage breaker is turned on.	<ul style="list-style-type: none"> • Check if the power cable is securely connected to the power supply. • Check if the power fails.
An error code (Er.) is displayed.	<ul style="list-style-type: none"> • Check the error code. • Check the error code on P.40 "Safety Device and Error Code".
The circulating fluid does not circulate.	<ul style="list-style-type: none"> • Check if the circulating path is blocked or extremely constricted. • Check if the specific gravity and viscosity of the cooling fluid is proper. • Check if the circulating pump output is "off."
The temperature does not rise.	<ul style="list-style-type: none"> • Check if the set temperature is lower than the inside temperature of the bath. • Check if the voltage of the supplied power has dropped. • Check if the ambient temperature has dropped. • Check if the cooling load inside the bath has increased.
The temperature does not drop.	<ul style="list-style-type: none"> • Check if the set temperature is higher than the inside temperature of the bath. • Check if the voltage of the supplied power has dropped. • Check if the ambient temperature has risen. • Check if the heat load inside the bath has increased. • Check if the area around the vent is blocked. • Check if the condenser fin is contaminated. • Check if the condenser filter is clogged.
The temperature may rise slightly up higher than its set.	<ul style="list-style-type: none"> • Check if the temperature is set higher than 40.1°C. <p>Note: When the temperature is set higher than 40.1°C, the temperature may be slightly higher than its set because of Agitating Motor heat through the shaft depending on the ambient temperature and the heat radiation through the Unit exterior.</p>
The temperature varies in the middle of operation.	<ul style="list-style-type: none"> • Check if the set temperature is proper. • Check if the voltage of the supplied power has dropped. • Check if the variation in the ambient temperature has increased. • Check if the load inside the bath has increased.
The displayed temperature does not match the measured temperature.	<ul style="list-style-type: none"> • Check if the set value of calibration offset is other than "0." Set it at "0." • Check the set value according to the attached "Operation Manual for the Model CR5 Program Controller."

In the case if the error other than listed above occurred, turn off the power switch and primary power source immediately. Contact the shop of your purchase or nearest Yamato Scientific Service Office.

In Case of Request for Repair

If the failure occurs, stop the operation, turn OFF the power switch, and unplug the power plug. Please contact the sales agency that this unit was purchased, or the Yamato Scientific's sales office.

< Check following items before contact >

- ◆ Model Name of Product
 - ◆ Production Number
 - ◆ Purchase Date
 - ◆ About Trouble (in detail as possible)
- } See the production plate attached to this unit.

Minimum Retention Period of Performance Parts for Repair

The minimum retention period of performance parts for repair of this unit is 7 years after discontinuance of this unit.

The "performance part for repair" is the part that is required to maintain this unit.

Product Name		Thermo Elite	
Model		BH401	BH501
Circulation unit		External sealed unit circulation	
Usable ambient temp.		5°C~30°C	
Performance	Temperature control range	Room temp.+15°C~100°C	Room temp.+15°C~200°C
	Temperature adjustment accuracy	±0.1°C (water, room temp.+15°C~80°C) ±0.1°C (silicon oil KF96/50cst, 70°C~200°C)	
	Circulation/Stirring method	Jet pump circulation stirring/external sealed unit circulation method	
	Maximum flow rate (50/60Hz)	14L/min 15L/min (When the circulating pressure loss is 10 kpa or less)	
	Maximum head (50/60Hz)	2.8m/3.4m (flow rate: approx. 0.5L/min)	
Configurations	Inner bath	Stainless steel SUS304	
	Temperature control system	PID control by microcomputer	
	Sensor	Pt100Ω (temperature control) + K-thermocouple (overheating prevention)	
	Temperature setting/display method	Digital setting/display	
	Heater	Stainless pipe heater SUS316L	
		1kW	1.2kW
External circulating nozzle size	Both discharge and return ports: φ14		
Safety devices		Self-diagnostic functions (Failure in sensor, Heater disconnection, SSR short-circuit, Automatic overheating prevention device), Earth leakage breaker, Overheating prevention device, Pump thermal protector, Float switch	
Other functions		Key lock Function, Drain port, Calibration offset function, Alarm signal output, Temperature signal output, Time-up signal output, RS485 communication function	
Standard	Bath dimensions (W×D×H mm)	239×299×200	
	Effective internal dimensions (W×D×H mm)	227×150×200	
	External dimensions* (W×D×H mm)	310×396×607	
	Inside volume of bath (effective internal volume)	13L (10L)	
	Power supply (50/60Hz)	100V AC 11A	100V AC 13A
		Weight	
Optional accessories		Hose nipple (1/2×φ14): 2, Instruction manual (present volume), Operation manual for the model CR5 program controller	

* The depth does not include the external circulating nozzle.

BH401

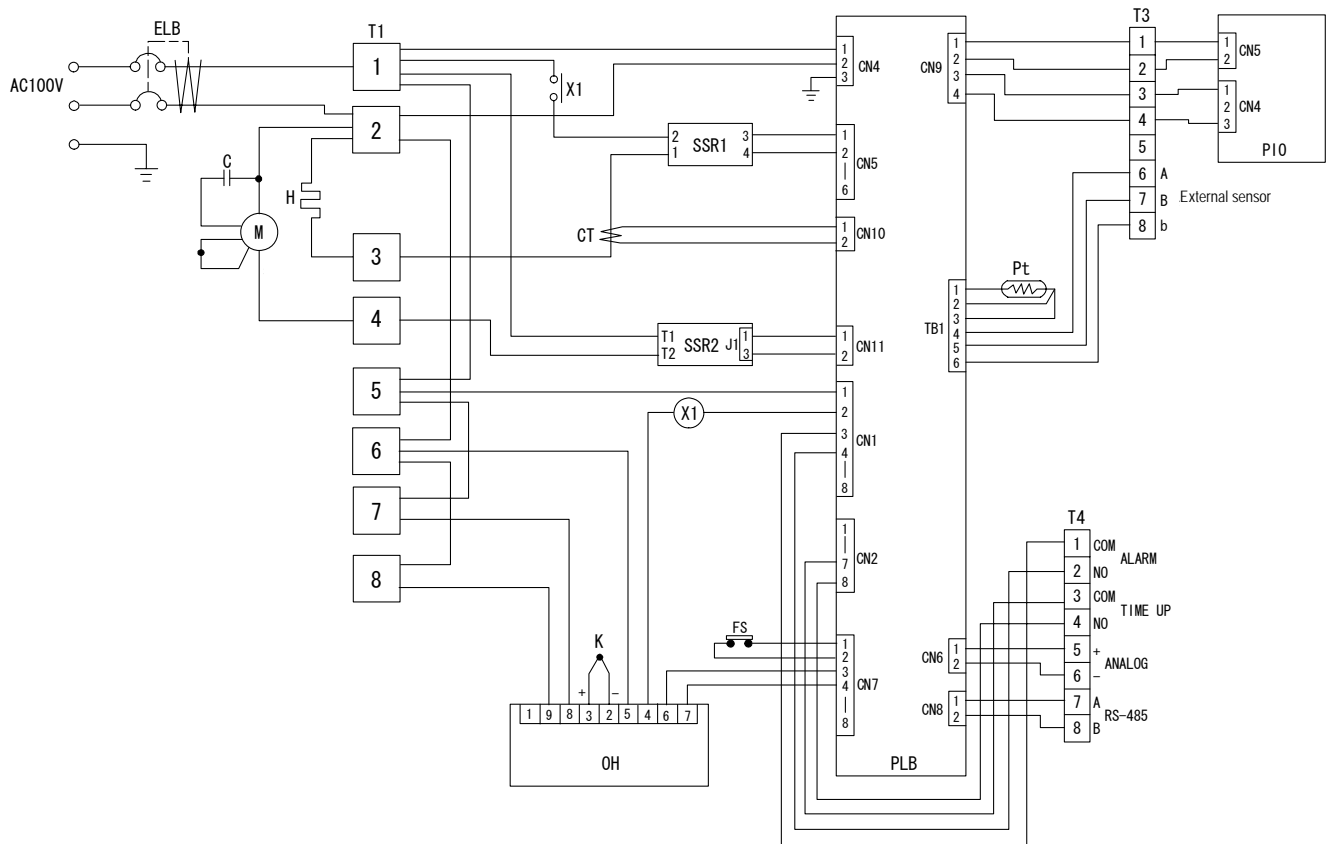

Symbol	Part name	Symbol	Part name
ELB	Earth leakage breaker	CT	Current transformer
T1, 3, 4	Terminal block	Pt	Temperature sensor (Pt 100 Ω)
X1	Relay (heater)	K	Temperature sensor (K-thermocouple)
H	Heater	SSR1, 2	SSR
M	Stirring motor	OH	Independent overheating prevention device
C	Phase-advancing condenser	PLB	PLANAR board
FS	Micro switch	PIO	Display board

BH501

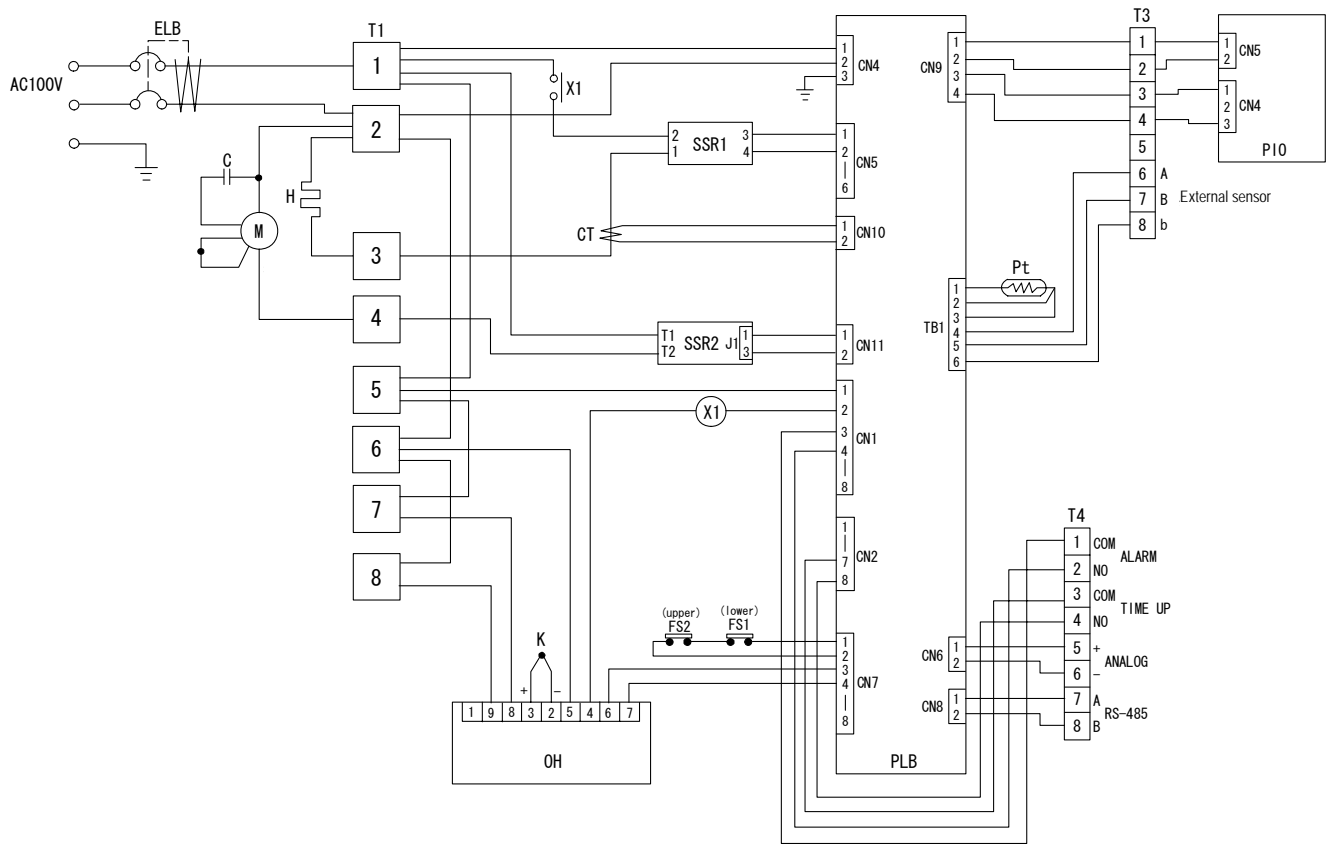

Symbol	Part name	Symbol	Part name
ELB	Earth leakage breaker	CT	Current transformer
T1, 3, 4	Terminal block	Pt	Temperature sensor (Pt 100Ω)
X1	Relay (heater)	K	Temperature sensor (K-thermocouple)
H	Heater	SSR1, 2	SSR
M	Stirring motor	OH	Independent overheating prevention device
C	Phase-advancing condenser	PLB	PLANAR board
FS1, 2	Micro switch	PIO	Display board

Replacement Parts Table

Common Parts

Symbol	Part Name	Code No.	Specification	Manufacturer
ELB	Earth leakage breaker	2060050001	BJS153	Matsushita
M	Motor	2140070002	U2035-1	Nihon Servo
SSR1	SSR	2060000035	TRS5225	Toho Denshi
SSR2	SSR	2060000030	YLT-SSR-02	Syclohm
X1	Relay	2050000056	G7L-1A-TUB 100V	OMRON
Pt (K)	Sensor	1160030037	—	Nihon Densoku
OH	Digital thermostat	2100110002	PAS3K1-0YB0Y	Fuji Denki
PLB	PLANAR board	LT00008565	IVCR5A	Toho Denshi
PIO	Display board	LT00008566	IVCR5A	Toho Denshi
CT	Current transformer	2170010005	CTL-6-S-H	URD
FS1	Micro switch	LT00017238	D2MC-01H	OMRON

BH401

Symbol	Part Name	Code No.	Specification	Manufacturer
H	Pipe heater	BF400-30021	1kW±5%	Izumi Dennetsu

BH501

Symbol	Part Name	Code No.	Specification	Manufacturer
H	Pipe heater	BF600-30011	1.2kW±5%	Izumi Dennetsu
FS2	Micro switch	LT00017239	D2MC-01HL	OMRON

List of Dangerous Substances



Never use explosive substances, flammable substances and substances that include explosive or flammable ingredients in this unit.

EXPLOSIVE

EXPLOSIVE:	Ethylene glycol dinitrate (nitro glycol), Glycerin trinitrate (nitroglycerine), Cellulose nitrate (nitrocellulose), and other explosive nitrate esters
	Trinitrobenzene, Trinitrotoluene, Trinitrophenol (picric acid), and other explosive nitro compounds
	Acetyl hidroperoxide (peracetic acid), Methyl ethyl ketone peroxide, Benzyl peroxide, and other organic peroxides

FLAMMABLE

IGNITING:	Lithium (metal), Potassium (metal), Sodium (metal), Yellow phosphorus, Phosphorus sulfide, Red phosphorus, Celluloid compounds, Calcium carbide, Lime phosphate, Magnesium (powder), Aluminum (powder), Powder of metals other than magnesium and aluminum, Sodium hydrosulfite
OXIDIZING:	Potassium chlorate, Sodium chlorate, Ammonium chlorate, and other chlorate
	Potassium perchlorate, Sodium perchlorate, Ammonium perchlorate, and other perchlorate
	Potassium peroxide, Sodium peroxide, Barium peroxide, and other inorganic peroxide
	Potassium nitrate, Sodium nitrate, Ammonium nitrate, and other nitrate
	Sodium chlorite and other chlorites
	Calcium hypochlorite and other hypochlorites
INFLAMMABLE LIQUID:	Ethyl ether, Gasoline, Acetaldehyde, Propylene chloride, Carbon disulfide, and other flammable substances having a flash point of lower than -30°C
	Normal hexane, ethylene oxide, acetone, benzene, methyl ethyl ketone, and other flammable substances having a flash point of -30°C or higher but lower than 0°C
	Methanol, Ethanol, Xylene, Pentyl acetate (amyl acetate), and other flammable substances having a flash point of 0°C or higher but lower than 30°C
	Kerosene, Light oil (gas oil), Oil of turpentine, Isopentyl alcohol (isoamyl alcohol), Acetic acid, and other flammable substances having a flash point of 30°C or higher but lower than 65°C
FLAMMABLE GAS:	Hydrogen, Acetylene, Ethylene, Methane, Propane, Butane, and other flammable substances which assume a gaseous state at 15°C and 1 atm

(Source: Appendix Table 1 of Article 6 of the Industrial Safety and Health Order in Japan)

* Install the unit according the procedure described below (check options and special specifications separately).

Model	Serial number	Date	Person in charge of installation (company name)	Person in charge of installation	Judgment

No.	Item	Method	Reference operation manual	Judgment
Specifications				
1	Accessories	Check the quantities of accessories with the quantities shown in the Accessory column.	Specification	P.43
2	Installation	<ul style="list-style-type: none"> • Visually check the surrounding area. Caution: Pay attention to the ambient environment.	Before Using This Unit "1. Choose a proper place for installation"	P.4
		<ul style="list-style-type: none"> • Keep space. 		
		<ul style="list-style-type: none"> • Pour water into the water bath. 	Before Using This Unit "Installation Procedure"	P.7~
Operation				
1	Power voltage	<ul style="list-style-type: none"> • Using a tester, measure the voltage of the voltage used by the customer (distribution board, outlet, etc.). • Measure the voltage during operation (the voltage must be within the standard). Caution: When a unit is to be connected to the plug or breaker, use one that conforms to the standard.	Before Using This Unit "9. Always ground this unit"	P.6
			Before Using This Unit "7. Choose a correct power distribution board or receptacle"	P.6
			Specification	P.43
2	Start of operation	<ul style="list-style-type: none"> • Start operation. Set a value about 5°C lower than the room temperature, and check the stabilized state of the temperature drop time. Check: Water leakage is not permissible.	Refer to the attached "Operation Manual for the Model CR5 Program Controller."	
Description				
1	Description of operation	Explain the operation of each unit to the customer according to this Operation Manual.	Refer to the attached "Operation Manual for the Model CR5 Program Controller."	
2	Error code	Explain error codes and the procedure for resetting them to the customer according to this Operation Manual.	In the Event of Failure...	P.40~
3	Maintenance inspection	Explain the operation of each unit to the customer according to this Operation Manual.	Maintenance Method	P.38
4	Completion of installation Information to be entered	<ul style="list-style-type: none"> • Enter the date of installation and the name of the person in charge of installation on the face plate on the unit. • Enter necessary information on the guarantee, and pass it to the customer. • Explain the after-sale service route to the customer. 	After Service and Warranty	P. 42

Responsibility

Please follow the instructions in this document when using this unit. Yamato Scientific has no responsibility for the accidents or breakdown of device if it is used with a failure to comply. Never conduct what this document forbids. Unexpected accidents or breakdown may result in.

Note

- ◆ The contents of this document may be changed in future without notice.
- ◆ Any books with missing pages or disorderly binding may be replaced.

Instruction Manual for

Thermo Elite
Model BH401/501

Fourth Edition Feb. 21, 2012

Revised M a y , 10, 2012

Yamato Scientific Co., Ltd.

2-1-6 Nihonbashi Honcho, Chuo-ku,
Tokyo, 103-8432, Japan

<http://www.yamato-net.co.jp/>